

MADE
IN ITALY

SINGLE-MOTION
UNLATCHING
DOOR PULL

PBA IS THE PREMIER BRAND OF AISI 316L STAINLESS STEEL, THE HARDEST, MOST RESISTANT AND ELASTIC STEEL, OF THE ALUMINUM ALLOY EN-AW 6060 AND OF THE POLYAMIDE 6, THE MOST NOBLE OF THERMOPLASTIC RESINS. PBA HAS TWO CORE BUSINESS: THE ARCHITECTURAL HARDWARE, WITH A WIDE OFFER OF DOOR AND WINDOW LEVERS, KNOBS, PULLS, LOCKING AND NON-LOCKING LADDER PULLS, LOCKS, LOCKSET FOR GLASS AND ACCESSORIES AND THE DESIGN FOR ALL, A COMPLETE RANGE OF SANITARY ACCESSORIES AND ACCESSIBILITY PRODUCTS FOR BATHROOM. OUR PRODUCTS ARE DESIGNED TO PROMOTE INCLUSION AND A LIFE WITHOUT BARRIERS: WE BELIEVE THAT UNIVERSAL DESIGN IS THE DESIGN THAT ACCOMMODATES PEOPLE WITH DISABILITIES BUT IS JUST AS APPEALING TO PEOPLE WITHOUT THEM. WE ARE CONSCIOUS THAT BRINGING A NEW FORM INTO THE WORLD CAN AFFECT THE LIFE OF EVERYONE AND THAT THE OBJECTS REFLECT A SPACE, EMBODY ITS ATTITUDE, ILLUSIONS AND POSSIBILITIES. OUR PRODUCTS ARE USED IN THE MOST IMPORTANT PROJECTS WORLDWIDE; THE "PRODUCTION FLEXIBILITY" AND QUALITY ALLOW PBA TO BE THE PARTNER FOR THE FIRST CLASS OFFICE, RETAIL, PUBLIC SPACES, HOSPITALITY, RESIDENTIAL AND HEALTHCARE PROJECTS. PBA HAS BEEN AWARDED AND NOMINATED FOR MANY PRODUCTS BY DIFFERENT ORGANIZATIONS. PBA RECEIVED THE RED DOT AWARD FOR IT SERIES AND FOR ELICA LEVER, A COMPASSO D'ORO AWARD NOMINATION FOR ELICA LEVER AND K-LOCK PULL SERIES, AN ADI CERAMICS & BATHROOM DESIGN AWARD SPECIAL MENTION FOR CAP SERIES AND THE EVERYONE MILLWORK PULLS HAVE BEEN FINALIST AT IDEA - INTERNATIONAL DESIGN EXCELLENCE AWARDS. ALL OUR PRODUCTS ARE "MADE IN ITALY" BECAUSE WE BELIEVE IN THE IMPORTANCE TO CONTROL AND MANAGE ALL THE PRODUCTION CYCLE AND THE SUPPLY CHAIN; AT PBA WE WANT ENHANCE AND DEVELOP THE EXCELLENCE AND CAPABILITIES OF OUR HUMAN CAPITAL. PBA IS PRESENT IN MORE THAN 60 COUNTRIES AND HAS BRANCH IN THE USA.



pba S.p.A.



pba USA, Inc

THE SINGLE-MOTION UNLATCHING DOOR PULL IS *LIFE-SAFETY* HARDWARE THAT SECURES GLASS, WOOD, AND METAL DOORS WITH ULTRA-EASY INSTALLATION AND SIMPLE, INTUITIVE USE. IDEAL FOR MOST ANY TYPE OF SECURITY DOOR THAT DOES NOT REQUIRE PANIC HARDWARE, A GENTLE PUSH ON THE EXIT SIDE GRIP IS ALL THAT IS REQUIRED TO RELEASE THE LATCH AND OPEN THE DOOR. OPERABLE WITH A KEY OR ELECTRONIC CARD READER ON THE ENTRY SIDE, THE PULL REQUIRES NO ELECTRONIC SENSOR OR RELEASE BUTTON ON THE EGRESS SIDE. PERFECT FOR COMMERCIAL INTERIORS ACROSS EVERY SECTOR, PBA COLLABORATED WITH GENSLER, SERVING AS PRODUCT DESIGN CONSULTANT, ON THIS REVOLUTIONARY NEW PRODUCT THAT IS AVAILABLE IN A WIDE RANGE OF FINISHES.

SINGLE-MOTION UNLATCHING DOOR PULL

STAINLESS STEEL AISI 316L 

PBA IS THE PREMIER BRAND OF AISI 316L STAINLESS STEEL, THE HARDEST, MOST RESISTANT AND ELASTIC STEEL. THE STAINLESS STEEL AISI 316L IS AN AUSTENITIC ALLOY. IT IS DISTINGUISHED FROM OTHERS INOXIDIZABLE STEELS BY THE HIGH PERCENTAGE OF MOLYBDENUM WHICH GIVES IT A SPECIAL RESISTANCE TO PITTING CORROSION AND STRESS CORROSION. IN THIS KIND OF STAINLESS STEEL THE NICKEL'S PRESENCE IS INCREASED IN ORDER TO GUARANTEE STABILITY. FURTHER, THE "L" STANDS FOR "LOW CARBON", AND, IN FACT, THE QUANTITY IS LESS THAN OR EQUAL TO 0,03%.

PUSH COUPLER MADE IN ECONYL REGENERATED NYLON



THE FUTURE IS CIRCULAR: FROM WASTE, ECONYL® NYLON IS INFINITELY RECYCLABLE. THE PUSH COUPLER OF THE SINGLE-MOTION UNLATCHING DOOR PULL IS MADE FROM ECONYL®, 100% REGENERATED NYLON FROM WASTE SUCH AS FISHING NETS, OLD CARPETS DESTINED FOR LANDFILLS, PLASTIC COMPONENTS AND FABRIC SCRAPS FROM MILLS. AS WELL AS BEING A SOLUTION ON WASTE, ECONYL® REGENERATED NYLON IS ALSO A BETTER CHOICE WHEN IT COMES TO CLIMATE CHANGE. IT REDUCES THE GLOBAL WARMING IMPACT OF NYLON BY UP TO 90% COMPARED WITH THE MATERIAL FROM OIL. SINGLE-MOTION UNLATCHING DOOR PULL REPRESENTS A COMMITMENT TO SUSTAINABILITY AND TRULY RESPONSIBLE PRACTICES. WE CHOSE TO USE ECONYL® REGENERATED NYLON AS WE SUPPORT THE MISSION OF GIVING WASTE MATERIAL A NEW LIFE.

POWDER COATED ALUMINUM GRIP



ITEM

KLO.SLA.99RU.44



PULL MADE OF
STAINLESS STEEL
STANDARD SATIN

UPPER GRIP MADE OF
POWDER COATED ALUMINUM
STANDARD BLACK

ECONYL®
REGENERATED NYLON
PUSH COUPLER MADE OF
ECONYL® REGENERATED NYLON
STANDARD BLACK

LOWER GRIP MADE OF
POWDER COATED ALUMINUM
STANDARD BLACK

ACTIVATION
AREA



“PUSH” MARKING
OPTION SOON AVAILABLE
FOR UPPER ALUMINUM GRIP
ITEM KLO.SLA.PUSH.00

LEATHER WRAPPED ALUMINUM GRIP



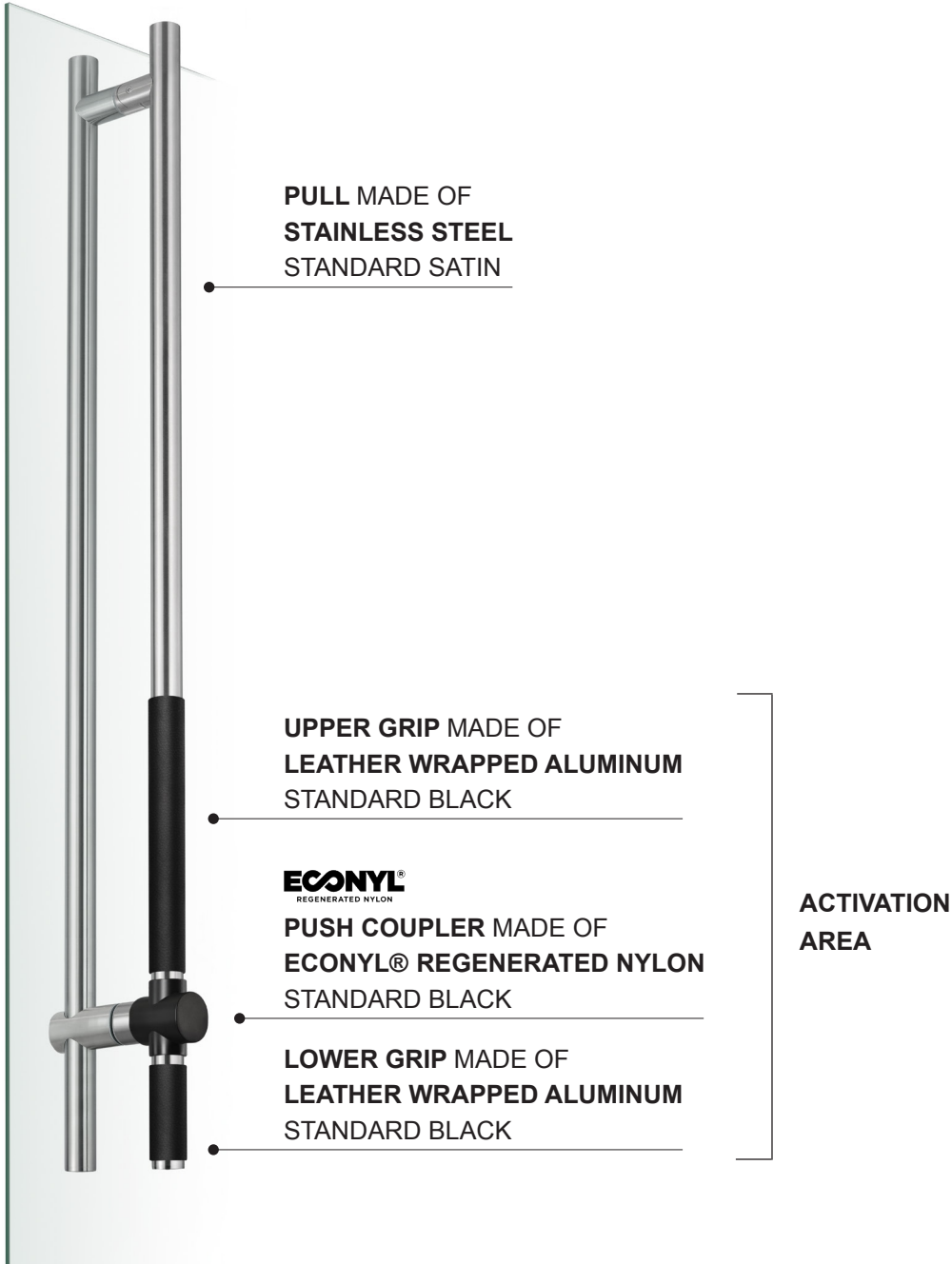

ITEM

KLO.SLL.99RU.44













PULL: AVAILABLE FINISH OPTIONS

STAINLESS STEEL AISI 316L

	.XX	FINISH CODE
Satin	.44	
Bright	.43	

STAINLESS STEEL POWDER COATED

Black Ral 9005 Matt	.40	
Black Ral 9005 Glossy	.26	
White Ral 9010	.31	
Grey	.32	
Champagne	.38	
Bronze	.39	
Architectural Bronze	.36	
Medium Bronze	.56	
Silver	.41	
Gold	.55	

ACTIVATION AREA: AVAILABLE FINISH OPTIONS

PUSH COUPLER



Black



White



GRIPS MADE OF POWDER COATED ALUMINUM



Black Ral 9005 Matt



.40

Other colors on request



.31

.38

.39

.32

GRIPS MADE OF LEATHER WRAPPED ALUMINUM

LEATHER



LEATHER STANDARD
21LT00004
CENTROCOT

Black PF

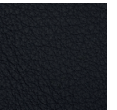

7150

EPD & PROCESS EPD
ISO 14025

LEATHER FROM ITALY
FULL CYCLE
UNI EN 16484:2015

TRACEABILITY
TRC_SC_410

CARBON FOOTPRINT
OF PRODUCT

DER BLAUER
ENGEL

OEKO-TEX

Other colors on request



EPD ENVIRONMENTAL PRODUCT DECLARATION

OUR CONTRIBUTION TO THE PROTECTION OF THE ECOSYSTEM

AN EPD IS AN ISO ENVIRONMENTAL DECLARATION BASED ON ISO 14025 AND ISO 21930 STANDARDS, TRANSPARENTLY REPORTING THE ENVIRONMENTAL PERFORMANCE OF PRODUCTS OR SERVICES FROM A LIFECYCLE PERSPECTIVE. THE PREPARATION OF AN EPD ENCOMPASSES VARIOUS STAGES, FROM ACQUIRING RAW MATERIALS TO THE END OF THE PRODUCT'S LIFE.

EPDS ADHERE TO INTERNATIONAL STANDARDS AND CONSIDER THE ENTIRE VALUE CHAIN. ADDITIONALLY, THE EPD IS A THIRD-PARTY VERIFIED DOCUMENT. WE ARE PROUD TO OFFER THE EPD FOR OUR PRODUCTS, AVAILABLE IN THE EPD LIBRARY.



pba FOR LEED® CERTIFICATION

OUR CONTRIBUTION TO THE EFFICIENCY AND SUSTAINABILITY OF BUILDINGS

LEED® (LEADERSHIP IN ENERGY ENVIRONMENTAL DESIGN) IS A VOLUNTARY CERTIFICATION SYSTEM FOR THE MANAGEMENT, DESIGN AND CONSTRUCTION OF BUILDINGS THAT ARE SUSTAINABLE FROM A SOCIAL, ENVIRONMENTAL AND ECONOMIC POINT OF VIEW AND IN TERMS OF THE WELLBEING OF THE USERS.

pba PRODUCTS CONTRIBUTE TOWARD SATISFYING PREREQUISITES AND CREDITS UNDER LEED®.

INTEGRATED PROCESS	IP	
MATERIALS AND RESOURCES	MR	
INDOOR ENVIRONMENTAL QUALITY	EQ	
INNOVATION	IN	



DECLARE LABEL

OUR DECLARE "RED LIST FREE" PRODUCTS FOR SUSTAINABLE BUILDINGS

THE DECLARE LABEL LISTS THE MATERIALS IN A PRODUCT TO DISCLOSE WHAT THEY ARE MADE OF, WHERE THEY ARE PRODUCED AND HOW THEY WILL BE DISPOSED OF. THIS LABEL IS A CALL FOR RESPONSIBILITY TO PRODUCERS AND USERS ALIKE. THE DECLARE LABEL IS A GUIDE TO SELECT PRODUCTS, PROVIDES INFORMATION IN A SIMPLE AND TRANSPARENT WAY AND RISES ABOVE GREENWASHING. DECLARE TAKES COMPLEX CHEMICAL ANALYSIS AND RAW MATERIAL SOURCE LOCATION INFORMATION TO ESTABLISH THAT PRODUCTS ARE FREE FROM HAZARDOUS CHEMICALS. ALL DECLARE LABEL OF pba PRODUCTS ARE RED LIST FREE.





SINGLE-MOTION UNLATCHING DOOR PULL

FOR SWING DOORS

S I N G L E
M O T I O N

UNLATCHES AND OPENS DOOR WITH A SINGLE MOVEMENT USING THE ACTIVATION AREA (PUSH COUPLER AND GRIPS).

A D A
< 5 lbf

THE ACTIVATION AREA (PUSH COUPLER AND GRIPS) IS OPERATED BY A FORCE LOWER THAN 5 LBF (22 N) UNTIL THE LOCKING LATCH CLEARS THE STRIKE (ADA 309.4 – OPERABLE PARTS).



SINGLE-MOTION UNLATCHING DOOR PULL
FOR SWING DOORS - PUSH

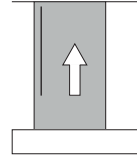

S I N G L E
M O T I O N

A D A
< 5 lbf



PAIRED WITH TOP STRIKE WITH ROLLER

INSIDE CLOSE THE DOOR TO LOCK

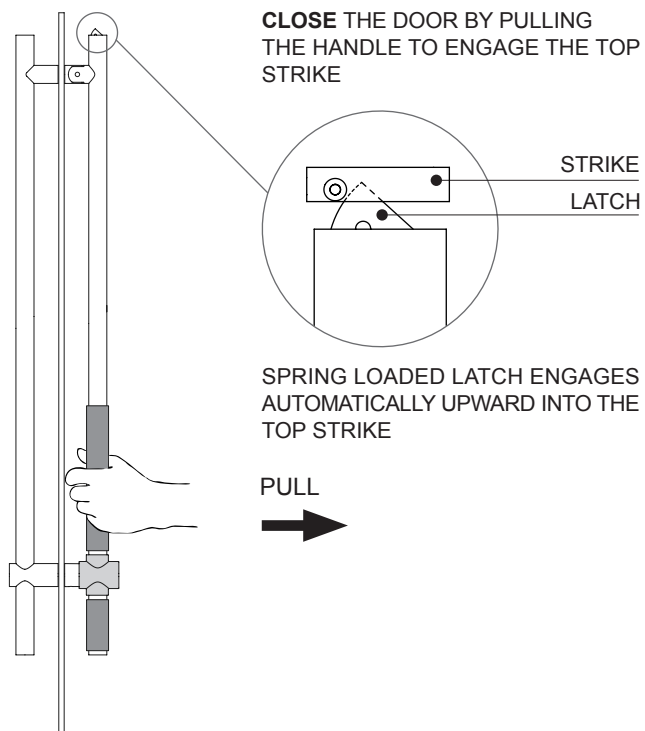

INSIDE UNLOCK AND OPEN DOOR VIA ACTIVATION AREA

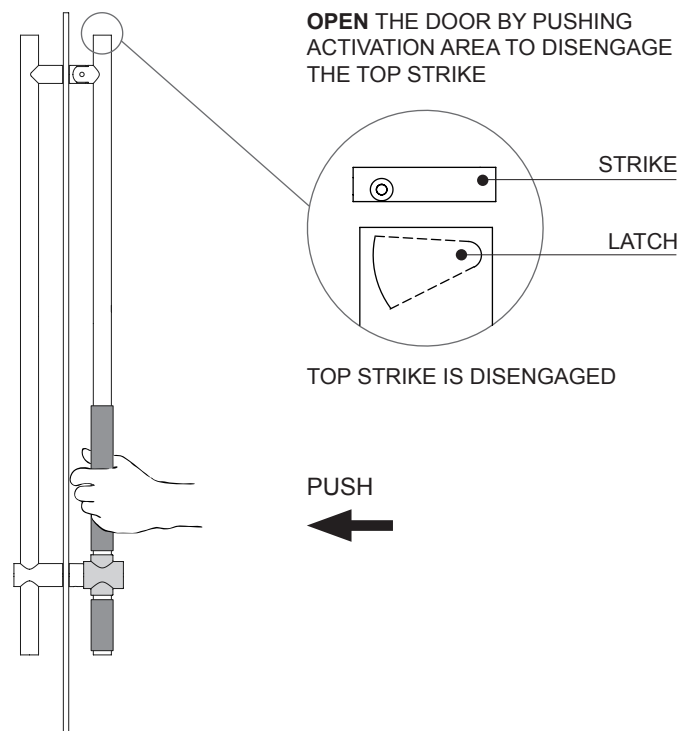

OUTSIDE CLOSE THE DOOR TO LOCK

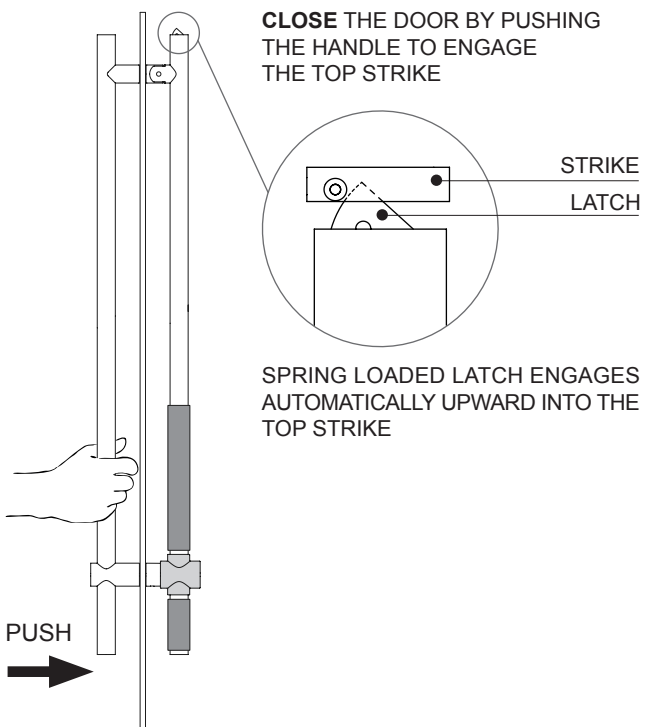

OUTSIDE USE KEY TO UNLOCK AND PULL THE HANDLE TO OPEN THE DOOR

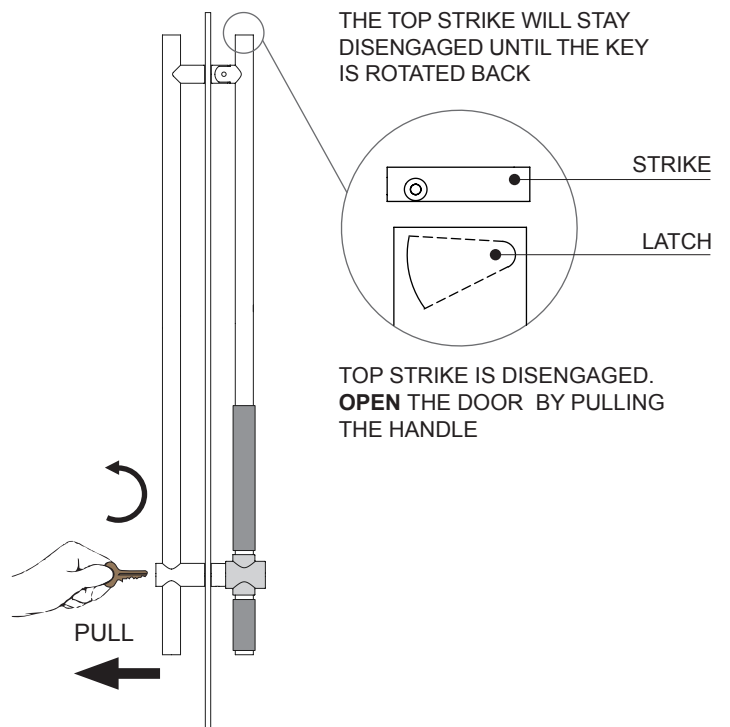

NOTE: THE USE OF THE TOP STRIKE WITH ROLLER PROVIDED BY pba IS MANDATORY.

PAIRED WITH TOP ELECTRIC STRIKE

OUTSIDE UNLOCK AND OPEN DOOR

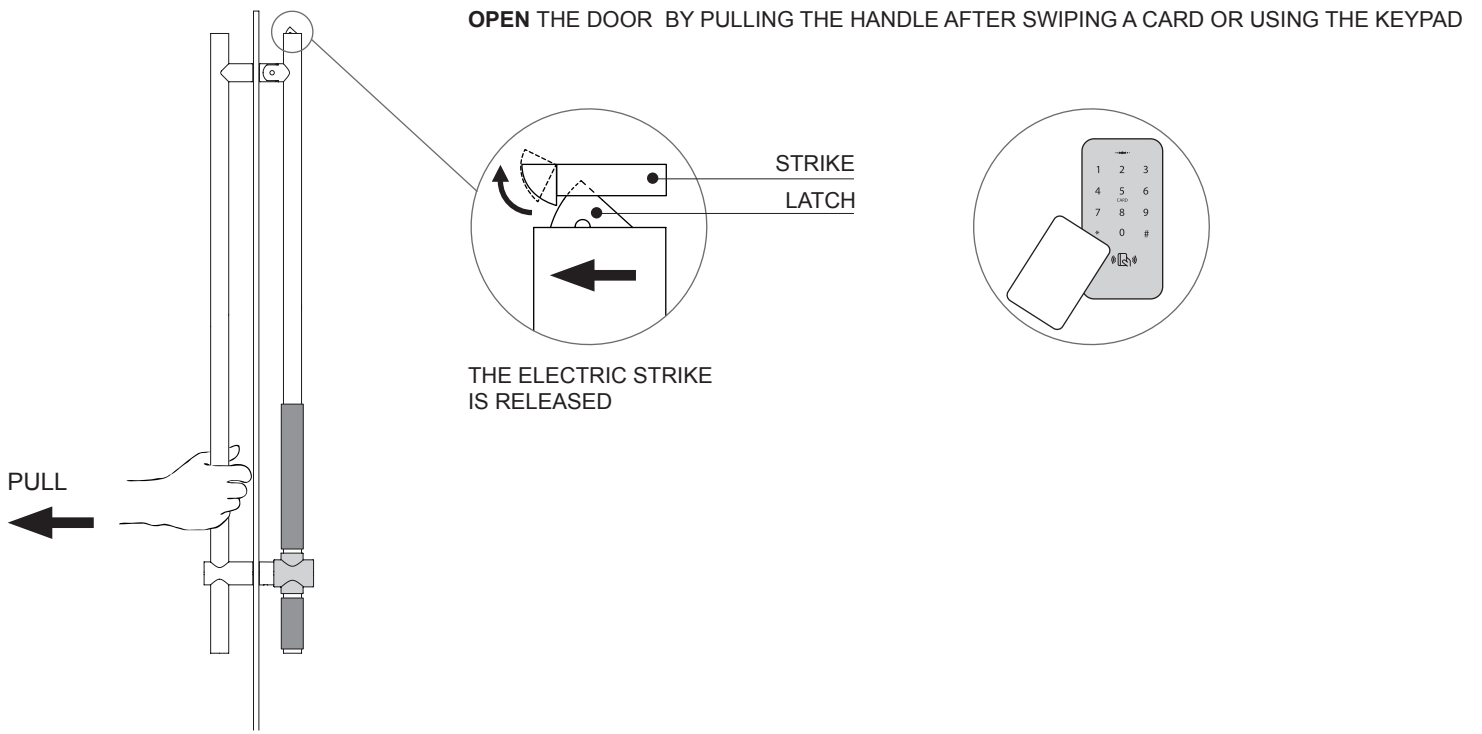

INSIDE UNLOCK AND OPEN DOOR VIA ACTIVATION AREA

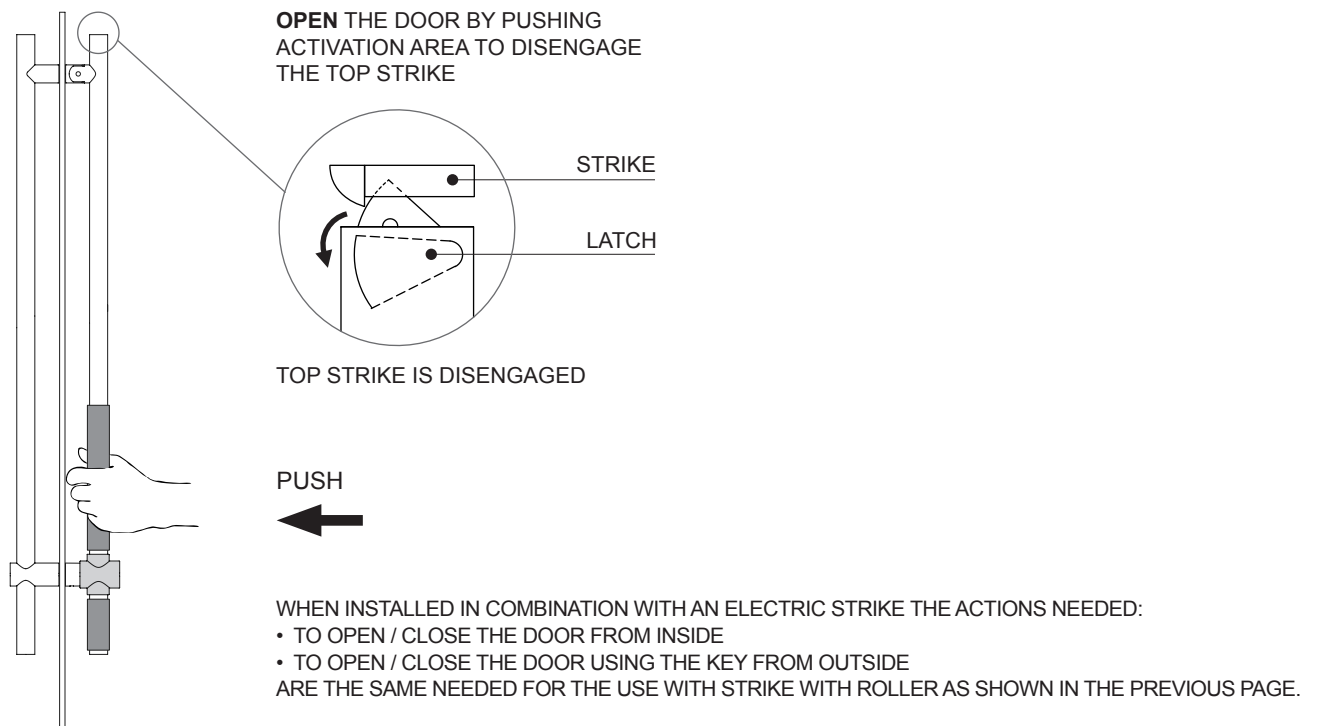

NOTE: A COMPATIBLE ELECTRIC STRIKE (NOT PROVIDED BY pba) HAS TO BE USED INSTEAD OF PBA'S STANDARD STRIKE WITH ROLLER. PLEASE REFER TO COMPATIBILITY CHART OR CONTACT pba.

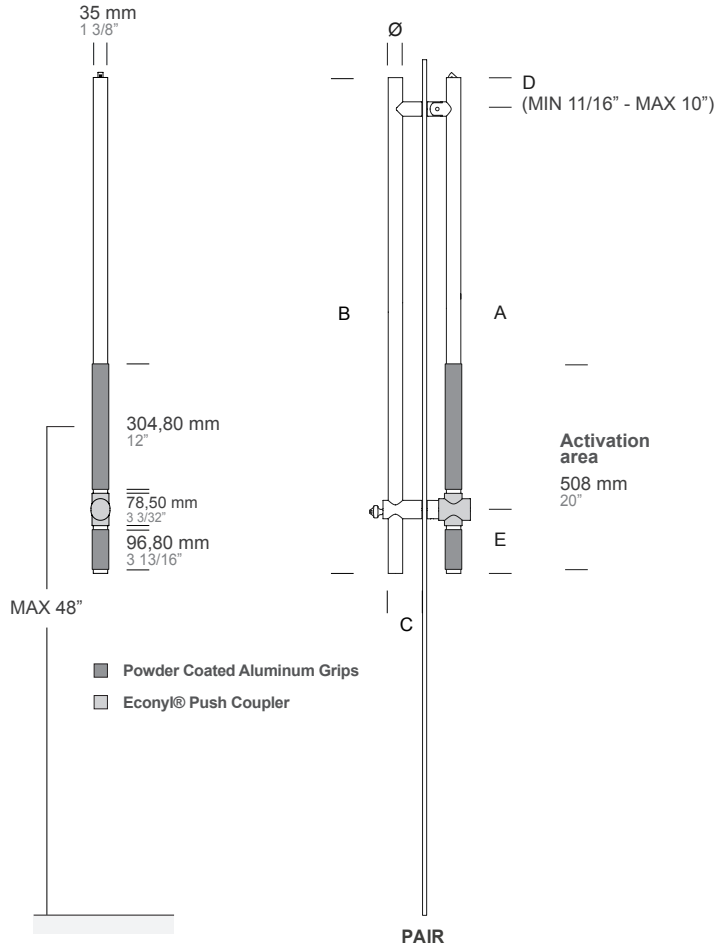
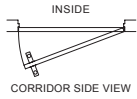
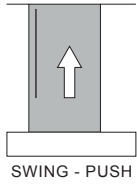

CYLINDER NOT INCLUDED

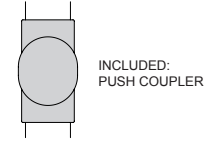

SUITABLE FOR USE WITH ELECTRIC STRIKE PROVIDED BY OTHERS (SEE PAGE 23)

ON REQUEST: CUSTOM BRACKETES FOR INSTALLATION OF TOP STRIKE

	ITEM	A	B	C	D	E	Ø
PAIR	KLO.SLA.RU60. xx	custom	1524 mm 60"	80 mm 3 1/8"	custom	152,40 mm 6"	35 mm 1 3/8"
TOP LOCKING	KLO.SLA.RU72. xx	custom	1828 mm 72"	80 mm 3 1/8"	custom	152,40 mm 6"	35 mm 1 3/8"
	KLO.SLA.RU84. xx	custom	2133 mm 84"	80 mm 3 1/8"	custom	152,40 mm 6"	35 mm 1 3/8"
	KLO.SLA.99RU. xx	custom	custom	80 mm 3 1/8"	custom	152,40 mm 6"	35 mm 1 3/8"

Dimension (A+D) MIN = 48" (1219,20 mm)

Dimension (A+D) MAX = 78" (1981,20 mm)

Upper grip midpoint has to be at MAX 48" (1219,20 mm) above finish floor

.XX = FINISH CODE

- .44 STANDARD FINISH CODE:
- SATIN STAINLESS STEEL PULL (ANSI/BHMA 630 - USD32D)
- BLACK POWDER COATED ALUMINUM GRIPS
- BLACK ECONYL® REGENERATED NYLON PUSH COUPLER

PULL: OTHER AVAILABLE OPTIONS

- .43 BRIGHT STAINLESS STEEL (ANSI/BHMA 629 - USD32)

STAINLESS STEEL POWDER COATED

- .40 BLACK RAL 9005 MATT
.26 BLACK RAL 9005 GLOSSY
.31 WHITE RAL 9010
.32 GREY
.38 CHAMPAGNE
.39 BRONZE
.36 ARCHITECTURAL BRONZE
.56 MEDIUM BRONZE
.41 SILVER
.55 GOLD

ACTIVATION AREA: OTHER AVAILABLE OPTIONS see page 8

EDGE COMPONENTS:

BLACK FOR DARK COLOR POWDER
GREY FOR LIGHT COLOR POWDER AND STAINLESS STEEL



Declare.



DOOR PREPARATION DP7
page 28

SPACERS FOR DOUBLE GLAZED DOOR
KLO.KIT.9RU2
page 27

STRIKE DETAILS
page 23

"PUSH" MARKING:
OPTION SOON AVAILABLE FOR UPPER ALUMINUM GRIP ADD ITEM KLO.SLA.PUSH.00

THESE PRODUCTS CONTRIBUTE TO LEED® CREDITS

THE MANUFACTURER RESERVES THE RIGHT TO ALTER, IMPROVE AND DISCONTINUE ANY FEATURES OF THE PRODUCT [MAKE CHANGES AND IMPROVEMENTS IN DESIGNS AND DIMENSIONS] WITHOUT NOTICE.

ALL DIMENSIONS IN THE CATALOG DRAWINGS ARE APPROXIMATIONS. REQUEST THE APPROPRIATE TECHNICAL DRAWING BEFORE DOOR PREPARATION AND INSTALLATION.

BRAND OF COMPATIBLE RIM CYLINDER:

- | | |
|------------------|------------|
| - ARROW | - BEST |
| - CORBIN RUSSWIN | - KABAILCO |
| - MEDECO | - SARGENT |
| - SCHLAGE | - YALE |

COMBINED NON LOCKING

ITEM
KLO.0G2.99RU

PUSH



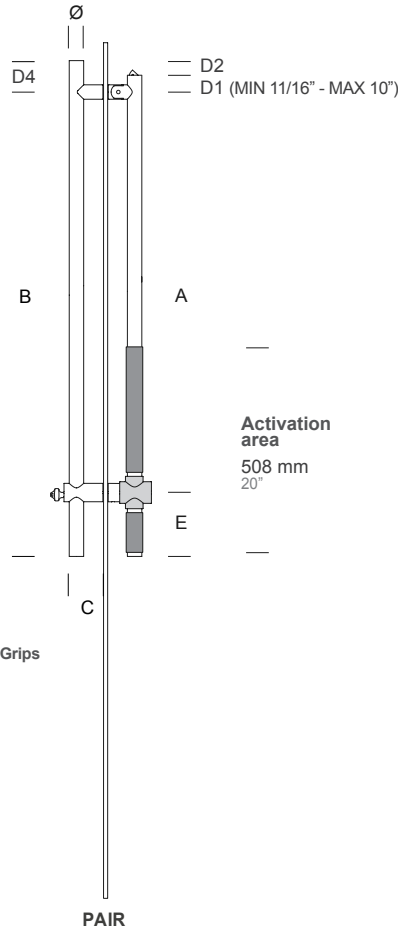
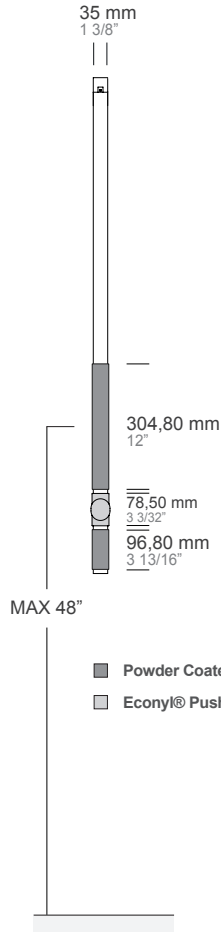
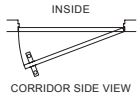
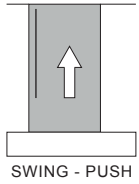

CYLINDER NOT INCLUDED

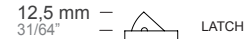
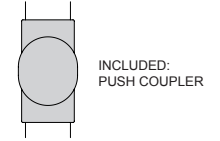

SUITABLE FOR USE WITH ELECTRIC STRIKE PROVIDED BY OTHERS (SEE PAGE 23)

ON REQUEST: CUSTOM BRACKETES FOR INSTALLATION OF TOP STRIKE

ITEM	A	B	C	D1-D2-D4	E	Ø	
PAIR	KLO.SLA.99ZU. xx	custom	custom	80 mm 3 1/8"	custom	152,40 mm 6"	35 mm 1 3/8"

TOP LOCKING

Dimension (A+D1) MIN = 48" (1219,20 mm)
Dimension (A+D1) MAX = 78" (1981,20 mm)
Dimension D4 (D1 + D2)
Upper grip midpoint has to be at MAX 48" (1219,20 mm) above finish floor

.XX = FINISH CODE

- .44 STANDARD FINISH CODE:
 - SATIN STAINLESS STEEL PULL (ANSI/BHMA 630 - USD32D)
 - BLACK POWDER COATED ALUMINUM GRIPS
 - BLACK ECONYL® REGENERATED NYLON PUSH COUPLER

PULL: OTHER AVAILABLE OPTIONS

- .43 BRIGHT STAINLESS STEEL (ANSI/BHMA 629 - USD32)

STAINLESS STEEL POWDER COATED

- .40 BLACK RAL 9005 MATT
- .26 BLACK RAL 9005 GLOSSY
- .31 WHITE RAL 9010
- .32 GREY
- .38 CHAMPAGNE
- .39 BRONZE
- .36 ARCHITECTURAL BRONZE
- .56 MEDIUM BRONZE
- .41 SILVER
- .55 GOLD

ACTIVATION AREA: OTHER AVAILABLE OPTIONS see page 8

EDGE COMPONENTS:

- BLACK FOR DARK COLOR POWDER
- GREY FOR LIGHT COLOR POWDER AND STAINLESS STEEL



Declare.



DOOR PREPARATION DP7
page 28

SPACERS FOR DOUBLE GLAZED DOOR
KLO.KIT.9RUZ
page 27

STRIKE DETAILS
page 23

"PUSH" MARKING:
OPTION SOON AVAILABLE FOR UPPER ALUMINUM GRIP ADD ITEM KLO.SLA.PUSH.00

THESE PRODUCTS CONTRIBUTE TO LEED® CREDITS

THE MANUFACTURER RESERVES THE RIGHT TO ALTER, IMPROVE AND DISCONTINUE ANY FEATURES OF THE PRODUCT [MAKE CHANGES AND IMPROVEMENTS IN DESIGNS AND DIMENSIONS] WITHOUT NOTICE.

ALL DIMENSIONS IN THE CATALOG DRAWINGS ARE APPROXIMATIONS. REQUEST THE APPROPRIATE TECHNICAL DRAWING BEFORE DOOR PREPARATION AND INSTALLATION.

BRAND OF COMPATIBLE RIM CYLINDER:

- ARROW
- CORBIN RUSSWIN
- MEDECO
- SCHLAGE
- BEST
- KABAILCO
- SARGENT
- YALE

COMBINED NON LOCKING

ITEM
KLO.0G2.99ZU

PUSH



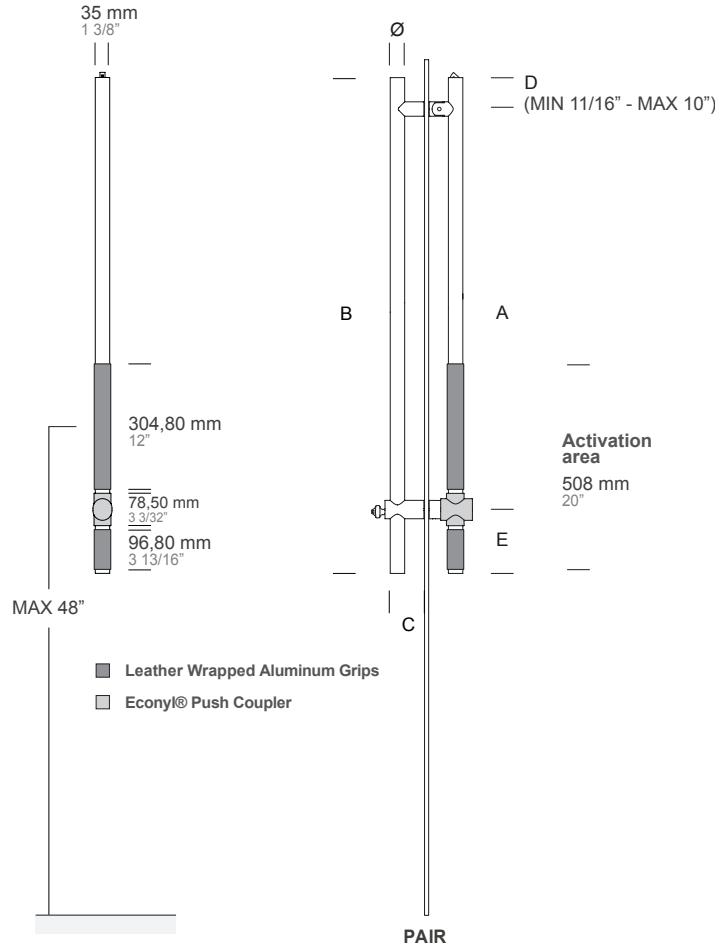
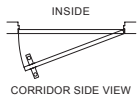
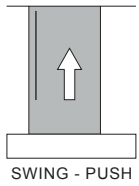

LEATHER WRAPPED ALUMINUM GRIPS



CYLINDER NOT INCLUDED



RIM CYLINDER WITH IC



RIM CYLINDER

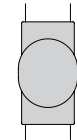

INCLUDED: PUSH COUPLER

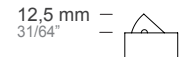

LATCH

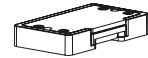

INCLUDED: TOP STRIKE WITH ROLLER

SUITABLE FOR USE WITH ELECTRIC STRIKE PROVIDED BY OTHERS (SEE PAGE 23)

ON REQUEST: CUSTOM BRACKETES FOR INSTALLATION OF TOP STRIKE

	ITEM	A	B	C	D	E	Ø
PAIR	KLO.SLL.RU60. xx	custom	1524 mm 60"	80 mm 3 1/8"	custom	152,40 mm 6"	35 mm 1 3/8"
TOP LOCKING	KLO.SLL.RU72. xx	custom	1828 mm 72"	80 mm 3 1/8"	custom	152,40 mm 6"	35 mm 1 3/8"
	KLO.SLL.RU84. xx	custom	2133 mm 84"	80 mm 3 1/8"	custom	152,40 mm 6"	35 mm 1 3/8"
	KLO.SLL.99RU. xx	custom	custom	80 mm 3 1/8"	custom	152,40 mm 6"	35 mm 1 3/8"

Dimension (A+D) MIN = 48" (1219,20 mm)

Dimension (A+D) MAX = 78" (1981,20 mm)

Upper grip midpoint has to be at MAX 48" (1219,20 mm) above finish floor

.XX = FINISH CODE

- .44 STANDARD FINISH CODE:
 - SATIN STAINLESS STEEL PULL (ANSI/BHMA 630 - USD32D)
 - BLACK LEATHER WRAPPED ALUMINUM GRIPS
 - BLACK ECONYL® REGENERATED NYLON PUSH COUPLER

PULL: OTHER AVAILABLE OPTIONS

- .43 BRIGHT STAINLESS STEEL (ANSI/BHMA 629 - USD32)

STAINLESS STEEL POWDER COATED

- .40 BLACK RAL 9005 MATT
 .26 BLACK RAL 9005 GLOSSY
 .31 WHITE RAL 9010
 .32 GREY
 .38 CHAMPAGNE
 .39 BRONZE
 .36 ARCHITECTURAL BRONZE
 .56 MEDIUM BRONZE
 .41 SILVER
 .55 GOLD

ACTIVATION AREA: OTHER AVAILABLE OPTIONS see page 8

EDGE COMPONENTS:

- BLACK FOR DARK COLOR POWDER
 GREY FOR LIGHT COLOR POWDER AND STAINLESS STEEL

DOOR PREPARATION DP7
 page 28

SPACERS FOR DOUBLE GLAZED DOOR
 KLO.KIT.9RU2
 page 27

STRIKE DETAILS
 page 23

THESE PRODUCTS CONTRIBUTE TO LEED® CREDITS

THE MANUFACTURER RESERVES THE RIGHT TO ALTER, IMPROVE AND DISCONTINUE ANY FEATURES OF THE PRODUCT [MAKE CHANGES AND IMPROVEMENTS IN DESIGNS AND DIMENSIONS] WITHOUT NOTICE.

ALL DIMENSIONS IN THE CATALOG DRAWINGS ARE APPROXIMATIONS. REQUEST THE APPROPRIATE TECHNICAL DRAWING BEFORE DOOR PREPARATION AND INSTALLATION.

BRAND OF COMPATIBLE RIM CYLINDER:

- | | |
|------------------|------------|
| - ARROW | - BEST |
| - CORBIN RUSSWIN | - KABAILCO |
| - MEDECO | - SARGENT |
| - SCHLAGE | - YALE |

COMBINED NON LOCKING

ITEM
 KLO.0G2.99RU



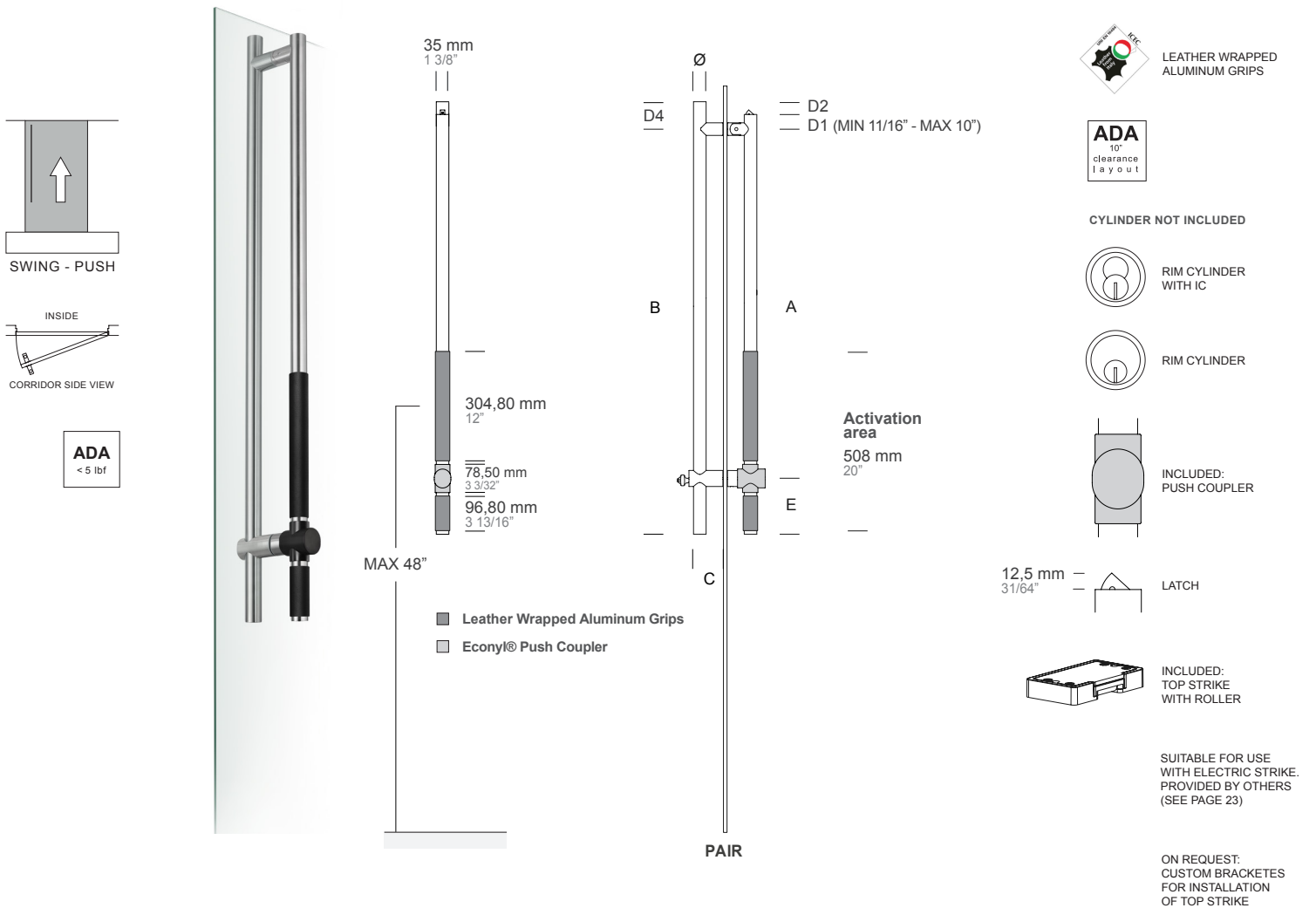

ITEM	A	B	C	D1-D2-D4	E	Ø	
PAIR	KLO.SLL.99ZU. xx	custom	custom	80 mm 3 1/8"	custom	152,40 mm 6"	35 mm 1 3/8"

TOP LOCKING

Dimension (A+D1) MIN = 48" (1219,20 mm)
 Dimension (A+D1) MAX = 78" (1981,20 mm)
 Dimension D4 (D1 + D2)
 Upper grip midpoint has to be at MAX 48" (1219,20 mm) above finish floor

- .XX = FINISH CODE
- .44 STANDARD FINISH CODE:
 - SATIN STAINLESS STEEL PULL (ANSI/BHMA 630 - USD32D)
 - BLACK LEATHER WRAPPED ALUMINUM GRIPS
 - BLACK ECONYL® REGENERATED NYLON PUSH COUPLER
- PULL: OTHER AVAILABLE OPTIONS**
- .43 BRIGHT STAINLESS STEEL (ANSI/BHMA 629 - USD32)
 - STAINLESS STEEL POWDER COATED**
 - .40 BLACK RAL 9005 MATT
 - .26 BLACK RAL 9005 GLOSSY
 - .31 WHITE RAL 9010
 - .32 GREY
 - .38 CHAMPAGNE
 - .39 BRONZE
 - .36 ARCHITECTURAL BRONZE
 - .56 MEDIUM BRONZE
 - .41 SILVER
 - .55 GOLD

ACTIVATION AREA: OTHER AVAILABLE OPTIONS see page 8

EDGE COMPONENTS:
 BLACK FOR DARK COLOR POWDER
 GREY FOR LIGHT COLOR POWDER AND STAINLESS STEEL

DOOR PREPARATION DP7
 page 28

SPACERS FOR DOUBLE GLAZED DOOR
 KLO.KIT.9RUZ
 page 27

STRIKE DETAILS
 page 23

THESE PRODUCTS CONTRIBUTE TO **LEED®** CREDITS

THE MANUFACTURER RESERVES THE RIGHT TO ALTER, IMPROVE AND DISCONTINUE ANY FEATURES OF THE PRODUCT [MAKE CHANGES AND IMPROVEMENTS IN DESIGNS AND DIMENSIONS] WITHOUT NOTICE.

ALL DIMENSIONS IN THE CATALOG DRAWINGS ARE APPROXIMATIONS. REQUEST THE APPROPRIATE TECHNICAL DRAWING BEFORE DOOR PREPARATION AND INSTALLATION.

BRAND OF COMPATIBLE RIM CYLINDER:

- ARROW	- BEST
- CORBIN RUSSWIN	- KABAILCO
- MEDECO	- SARGENT
- SCHLAGE	- YALE

COMBINED NON LOCKING

ITEM
 KLO.0G2.99ZU





TECHNICAL INFORMATION

CONFIGURATION TO COMPLY WITH ADA STANDARD

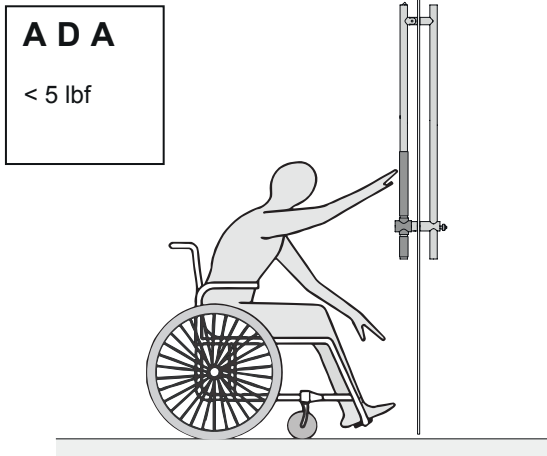

The activation area is operated by a force lower than 5 lbf (22 N) until the locking latch clears the strike.

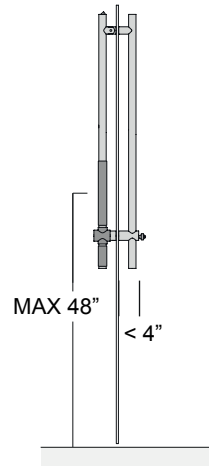
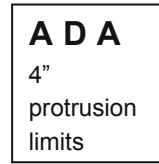
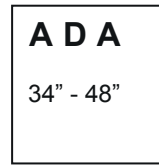

The activation area is located 34" to 48" above the floor or ground.

Protruding object shall protrude 4" maximum into the circulation path.

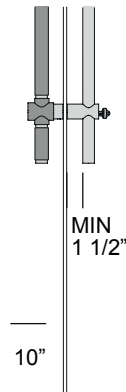
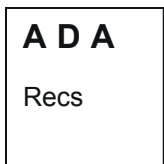
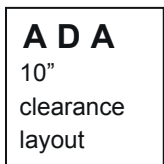

Designed to accommodate the ADA 10" clearance requirement at the push side of a swing door.

Single-Motion Unlatching Door Pull provides sufficient knuckle clearance (1 1/2" minimum) to facilitate gripping.

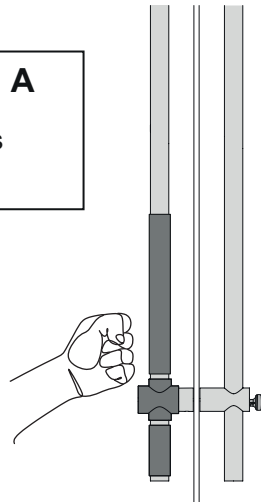
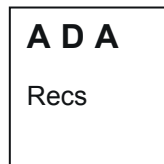

Single-Motion Unlatching Door Pull is usable with a closed fist of loose grip.

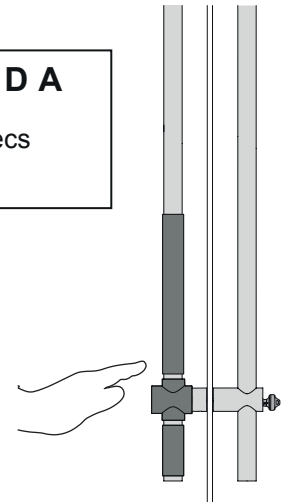
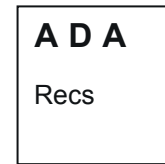

Single-Motion Unlatching Door Pull doesn't require hand or finger dexterity, fine motor movement, or simultaneous actions.

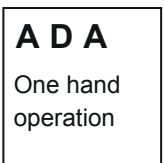

Single-Motion Unlatching Door Pull allows one-hand operation.

TO EGRESS

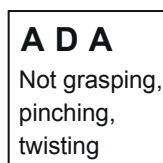

Single-Motion Unlatching Door Pull doesn't require tight grasping, pinching, or twisting of the wrist.

TO EGRESS

MANDATORY TOP STRIKE WITH ROLLER (INCLUDED)

TO ENSURE PROPER OPERATION, THE SINGLE MOTION UNLATCHING DOOR PULL SHOULD BE USED WITH THE pba "ROLLER" STRIKE SHIPPED WITH THE PRODUCT. THE pba STRIKE SHOULD BE REVIEWED AND APPROVED BY THE DESIGN TEAM FOR USE WITH THE INTENDED DEMOUNTABLE PARTITION SYSTEM. WHEN REQUIRED, CUSTOM STRIKES ARE AVAILABLE TO ADAPT THE PULL TO VIRTUALLY ANY DEMOUNTABLE PARTITION SYSTEM. CONTACT pba FOR MORE INFORMATION.

STANDARD:
TOP STRIKE WITH ROLLER INCLUDED



KLO.SKI.0008.44

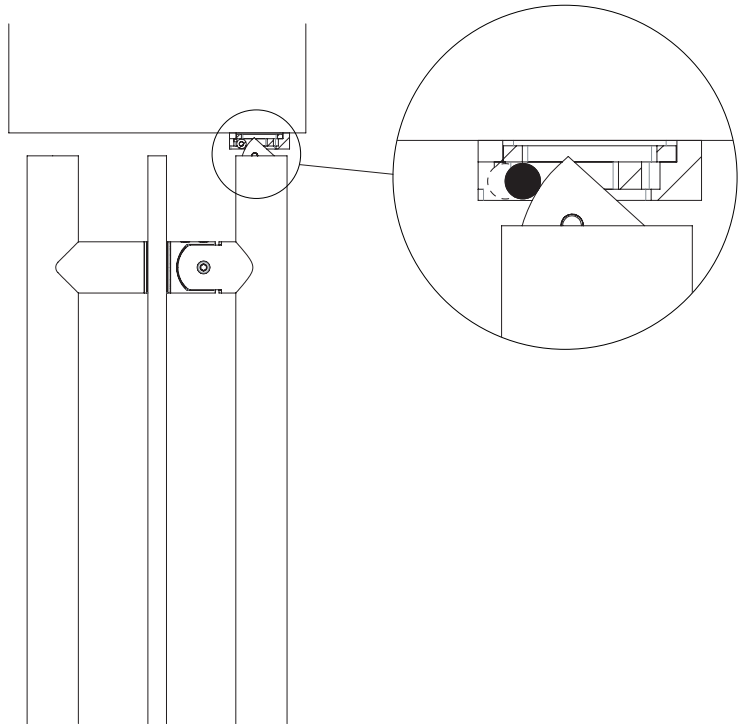

ELECTRIC STRIKE

THE SINGLE MOTION UNLATCHING DOOR PULL IS SUITABLE FOR USE WITH ELECTRIC STRIKE (PROVIDED BY OTHERS).

LIST OF COMPATIBLE TESTED ELECTRIC STRIKES:

- ASSA ABLOY HES8000
- ASSA ABLOY HES4500
- ASSA ABLOY HES5200
- ASSA ABLOY FOLGER ADAM 310 SERIES
- ASSA ABLOY HES9100
- ASSA ABLOY HES9200
- ASSA ABLOY HES9500
- ASSA ABLOY HES9700

SEE PAGES 24-25 FOR TESTED ELECTRIC STRIKES INFORMATION.



PLEASE CONTACT pba TO VERIFY COMPATIBILITY OF OTHER ELECTRIC STRIKES.

PLEASE VERIFY THE POSSIBILITY OF CORRECT PAIRING AND ELECTRICITY SUPPLY AS PER pba's INSTALLATION INSTRUCTIONS AND ELECTRIC STRIKE MANUFACTURER'S INSTALLATION INSTRUCTIONS.

COMPATIBLE ELECTRIC STRIKES

ASSA ABLOY HES8000

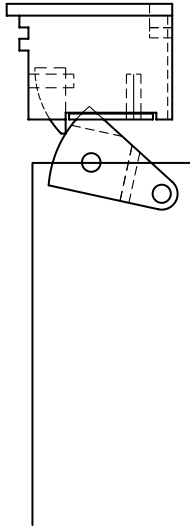

ASSA ABLOY HES4500

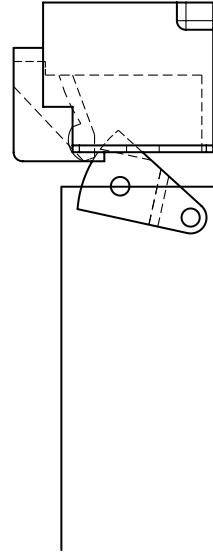

ASSA ABLOY HES5200

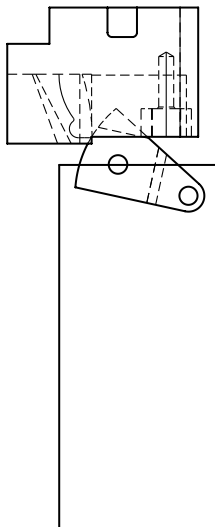

ASSA ABLOY FOLGER ADAM 310 SERIES

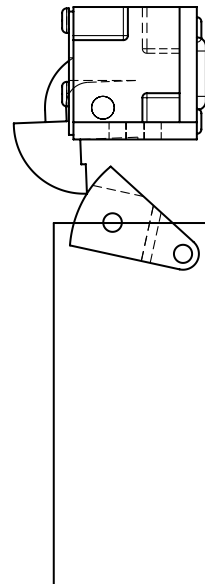

COMPATIBLE ELECTRIC STRIKES

HES9100
HES9200

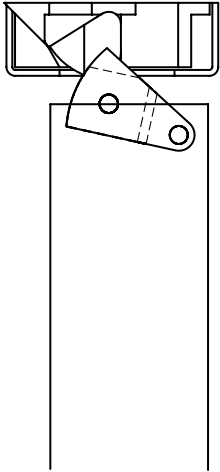

HES9500

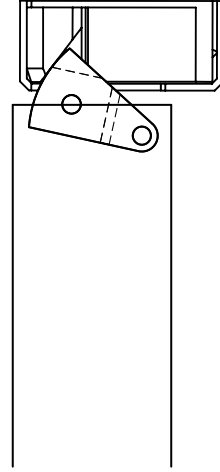

HES9700

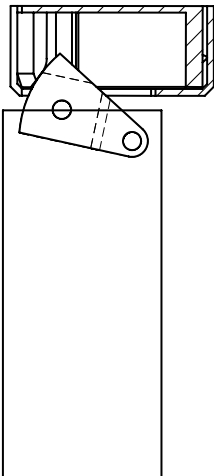

STANDARD ADJUSTABLE STRIKE INCLUDED

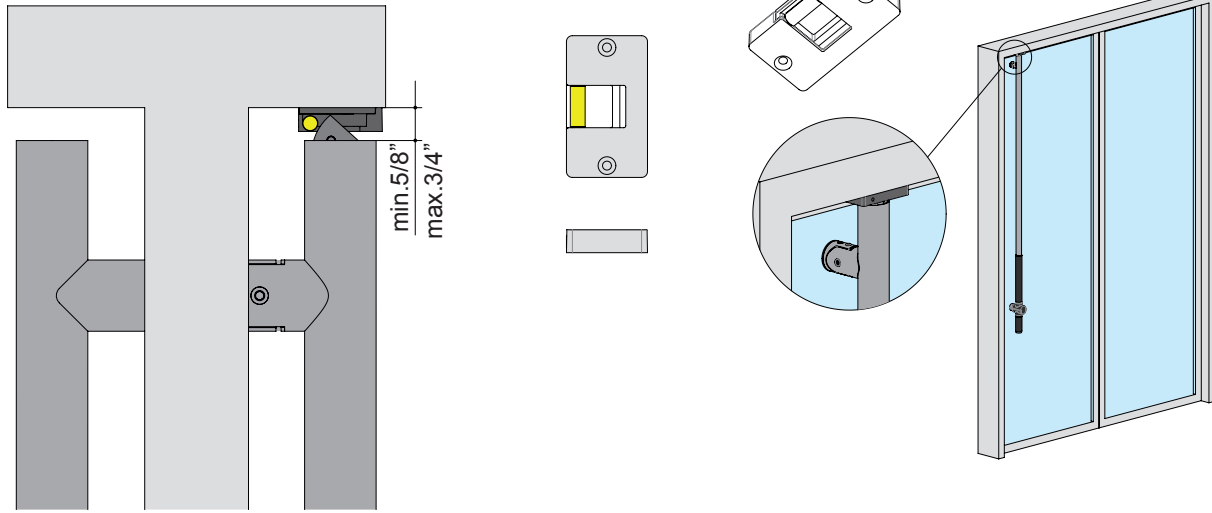

CUSTOM BRACKETS FOR STANDARD STRIKE

TAILOR-MADE "L" SHAPED PLATE FOR STANDARD STRIKE
ON REQUEST

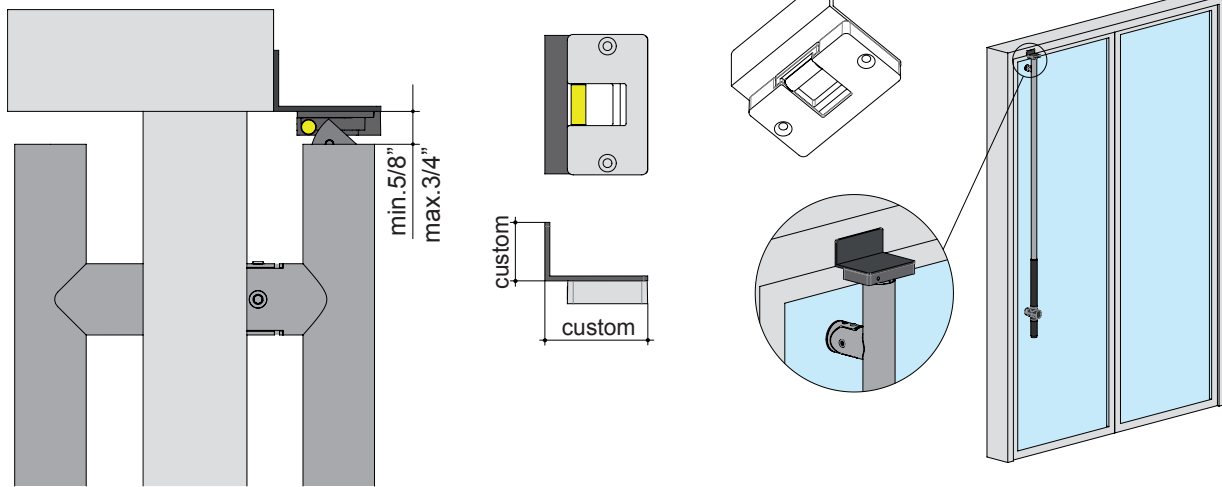

TAILOR-MADE STRAIGHT PLATE FOR STANDARD STRIKE
ON REQUEST

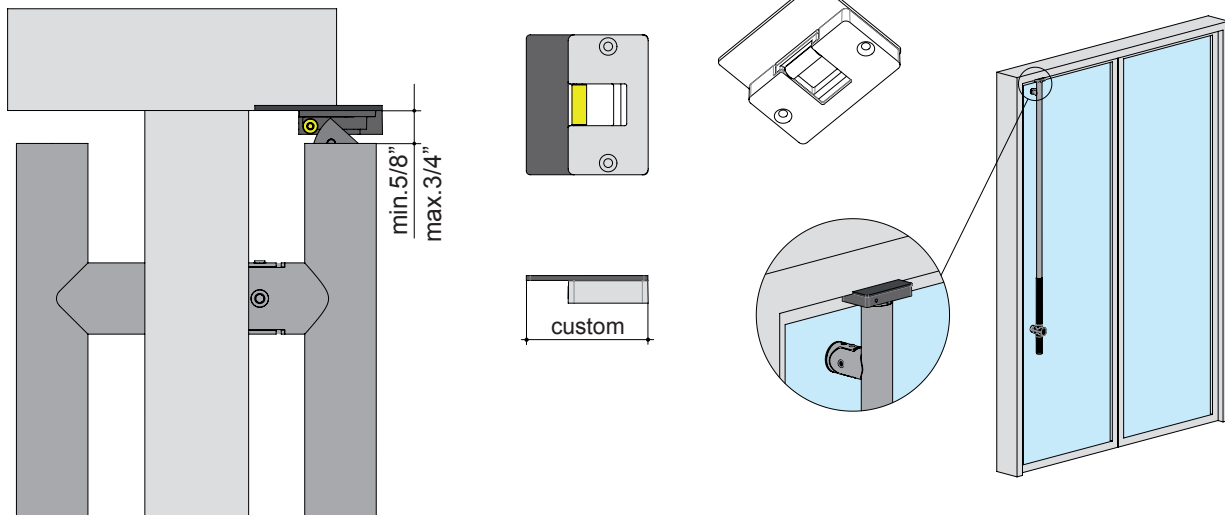

CYLINDER COMPATIBILITY

RIM CYLINDERS - FOR ALUMINUM LOCKING LADDER PULLS

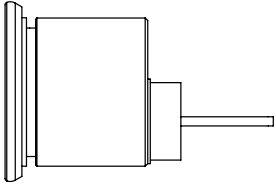

PBA UNIVERSAL BACKPLATE INCLUDED WITH LOCKING PULL
ALLOWS TO ACCOMMODATE ANY RIM CYLINDER BRAND OR FORMAT

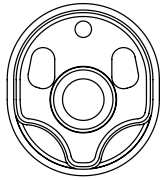

AVAILABLE FORMATS:

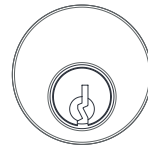

CONVENTIONAL

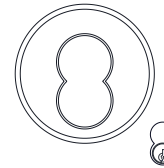

HOUSING FOR SFIC

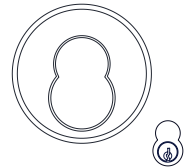

HOUSING FOR LFIC

SPACERS FOR DOUBLE GLAZED DOOR

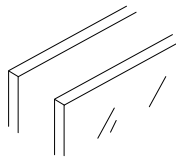

Double glazed doors

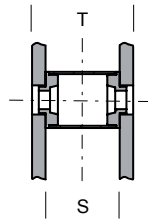

T = custom
S = custom

OVAL + ROUND SPACERS

KLO LINE RIM - SPACERS FOR STAINLESS STEEL Ø35 LOCKING AND NON LOCKING PULLS

1 OVAL POST (BOTTOM) + 1 Ø35 ROUND POST (TOP)

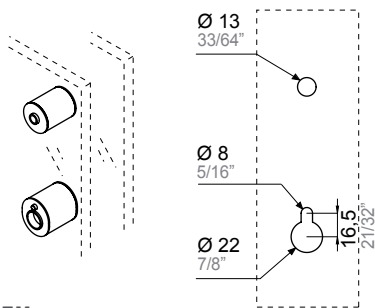

ITEM
KLO.KIT.9RU2

INSTALLATION ON ANY TYPE OF MATERIAL

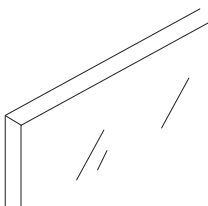

GLASS DOORS

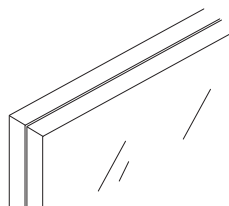

DOUBLE GLAZED DOORS

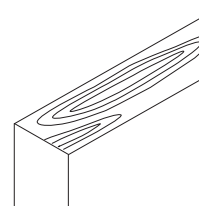

WOOD DOORS

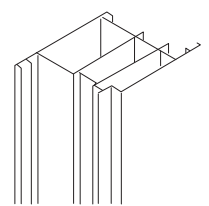

METAL DOORS

DP7 - DOOR PREPARATION FOR SINGLE-MOTION UNLATCHING DOOR PULLS

HOLES DIAMETERS AND CENTER TO CENTER SIZES

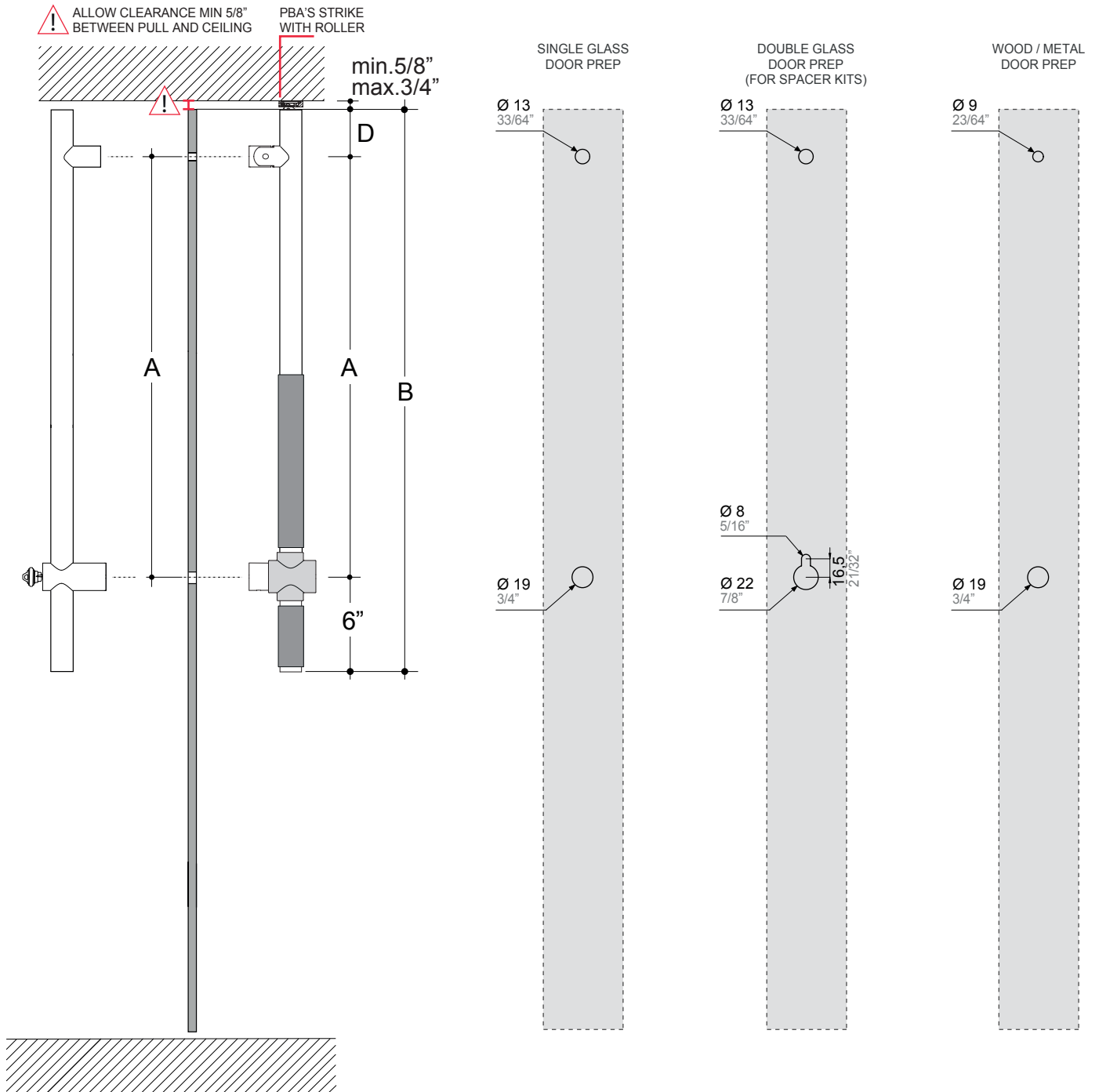



MAINTENANCE

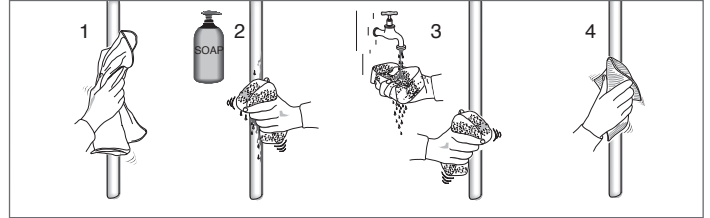
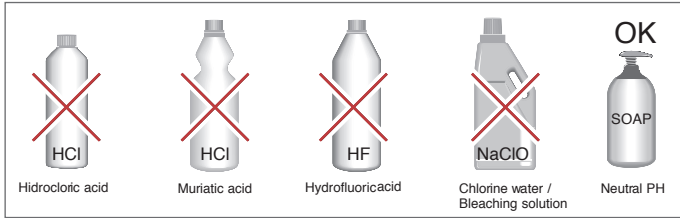

ADA

The Americans with Disabilities Act of 1990 (ADA), including the following amendments, fixes that door and gate hardware shall be operable with one hand and shall not require tight grasping, pinching and twisting of the wrist. Moreover a force of maximum 5 pounds (22,2 N) is required to operate the hardware. All pba ADA products are designed and produced in compliance of the above requirements. Final interpretation of ADA compliance is the responsibility of the specifier and should be determined relative to specific project conditions and local codes.

GENERAL CONDITIONS OF SALE

1. AGREEMENT

1.1 The supply of the products shown in this pricelist ("Products") of PBA SpA ("PBA") shall be governed by these general conditions of sale ("General Conditions"). These General Conditions shall apply also to the sale of spare parts, when possible.

1.2 The sale agreement of the Products ("Agreement") is entered into force among the parties upon the Client's receipt of PBA's order confirmation.

These General Conditions shall be deemed as an integral and essential part of any Agreement.

1.3 These General Conditions shall be executed by the Client and attached to the first purchase order sent to PBA, it being agreed that they shall accordingly apply to any following Agreement.

1.4 These General Conditions shall be deemed as tacitly accepted by the Client for any supply of Products, unless expressly rejected in writing by the Client by means of notice thereof to be sent to PBA at the latest within 5 (five) days as of the date of receipt of PBA's confirmation of the first purchase order sent by the Client.

Should the Client expressly reject one or more of these General Conditions within the above term, PBA shall be free to withdraw from the relevant Agreement, by means of written communication thereof and without any further obligation.

1.5 In no event shall any general conditions of any nature, inserted and/or specified in the Client's order forms and/or in other documents sent to PBA by the Client, and/or of which the latter was made aware in any manner whatsoever, apply to any Agreement and/or to any supply of Products.

Any special term and/or condition of supply suggested by the Client shall apply to the Agreement only if expressly contained in PBA's order confirmation.

Any change and/or amendment to these General Conditions shall be binding and valid only if accepted in writing by both parties.

2. PLACE AND TERMS OF DELIVERY OF THE PRODUCTS

2.1 The choice of an Incoterm does not affect the location of the place of delivery of the Products which, in any case, shall be deemed as delivered to the Client at the place and in the moment in which they are put at disposal of the haulier, for the relevant transport, at PBA's premises in Tezze sul Brenta (Vicenza), Italy.

In any case, unless otherwise agreed in writing by the parties, PBA shall never be liable for delays accrued during the transportation.

2.2 The terms of delivery of the Products (i) are specified in PBA's order confirmation, (ii) are approximate and roughly set forth and (iii) in no case shall they be construed as of essence.

2.3 In case of delay in the delivery of the Products at PBA's premises, caused by a fortuitous event, force majeure or other causes not depending on PBA's willful misconduct and/or gross negligence, the Client shall not be entitled to claim any compensation for damages, nor to ask for the termination of the Agreement and/or for the reduction of the price of the Products.

3. INCOTERMS

Unless otherwise agreed in writing, the Products and the relevant prices are to be considered with delivery Ex-works (EXW – Incoterms 2000), PBA's premises in Tezze sul Brenta (VI), Italy or at the different place indicated by PBA in the notice Products ready for delivery.

4. ORDERS – NON STANDARD AND/OR MADE TO MEASURE PRODUCTS

4.1 The purchase orders shall be made in writing and completed with all the data required for the relevant design and manufacture.

4.2 When already approved by the Client for the supply of catalogue Products, it is agreed that these General Conditions shall also apply to the sale orders related to non standard Products, Products out of catalogue and/or to be made to measure, if confirmed by PBA.

4.3 Any delay of the Client in the transmission of data, measures and/or technical specifications of the Products subject matter of the Agreement may cause a proportional postponement of the delivery terms, to be newly determined by PBA on the basis of its industrial needs.

5. PRICES AND PAYMENTS

5.1 The prices of the Products indicated in this pricelist are merely indicative and can be modified at any time by PBA.

The actual price of the Products is specified in PBA's order confirmation and, unless otherwise specified, it is deemed as net of VAT.

Any change and/or modification of the Products, agreed by the parties after the transmission of PBA's order confirmation, shall cause the adjustment of the relevant price due to any increase of the costs of production and/or of the raw materials, as agreed from time to time by the parties.

5.2 The price of the Products shall be paid by the Client as per the terms and ways specified in PBA's order confirmation, or otherwise agreed by the parties.

Any late collection or non collection of the Products shall not cause an extension and/or postponement of the terms of payment.

5.3 PBA shall be entitled to suspend the delivery of the Products should:

(a) the Client's assets and/or financial standings endanger the relevant payment; (b) the Client fail to timely pay Products previously supplied by PBA, also on the basis of other Agreements, until full payment of the outstanding credit and/or until receipt of proper guarantees of the Client for any delivery in progress, without prejudice to PBA's right to claim for any damages suffered as a consequence thereof.

5.4 In no event shall any vice and/or defect of the Products, even when expressly acknowledged as such by PBA, and/or any delay of delivery to the agreed terms give the Client the right to suspend the relevant payments and/or any other payment for whichever reason due to PBA also under other contractual relationships.

5.5 In case of late payments, PBA shall be entitled to charge interests on the unpaid amount at the rate provided by the law.

5.6 In no case shall the Client be entitled to set off any amount due to PBA in force of any Agreement against any amount due by PBA at any title whatsoever.

6. RETENTION OF TITLE

PBA shall be the sole owner of the Products until the date of their full payment.

Should the Agreement be terminated due to the Client's breach of contract, any Client's advance payment shall be kept by PBA as an indemnity within the limits set forth by the law, without prejudice to the latter's right to claim for further damages.

7. WARRANTY

7.1 PBA guarantees that the Products will be free from vices and defects in materials and workmanship for a period of 24 (twenty-four) months as of the date of the relevant delivery ("Warranty Period").

7.2 Should the complaints raised by the Client within the Warranty Period with reference to the Products be grounded and accepted by PBA, the latter shall, at its exclusive discretion, repair and/or replace the defective Product/s or the defective component/s of the same, with delivery Ex-works (EXW Incoterms 2000) PBA's premises in Tezze sul Brenta (VI), Italy.

The warranty obligations herewith undertaken shall be effective and binding only provided that PBA has the opportunity to verify the vices and/or defects raised by the Client.

PBA's warranty obligation shall be deemed as entirely fulfilled with the removal of the vice and/or defect raised by the Client, or with the replacement of the defective Product and/or component, without any further obligations.

Unless otherwise agreed in writing by the parties, all the expenses for returning to PBA the defective Products and/or components, as well as all the additional expenses related to the operations of repair or replacement shall be borne by the Client and shall be at the Client's risk.

7.3 Subject to the loss of warranty, the Client shall notify in writing, by registered letter return receipt requested, any vices and/or defects found within and not later than 8 (eight) days as of the date of the actual delivery of the Products, or, in case of hidden vices or defects, within and not later than 8 (eight) days as of the date of the relevant discovery.

7.4 The warranty is expressly excluded for vices and/or defects of the Products arising from or consisting in:

- (i) any repair, alteration and/or modification not authorized in writing by PBA;
- (ii) normal wear and tear of the materials or of single components;
- (iii) improper use and/or application of the Products;
- (iv) defects and/or mistakes in the measures and/or technical specifications supplied by the Client;
- (v) deposit, maintenance and/or cleaning not in compliance with PBA's instructions;
- (vi) installation not in compliance with PBA's instructions and/or carried out with non suitable materials;
- (vii) any other event for which PBA is not directly liable.

Should the Client fail to regularly pay the agreed price, even if such default or such delay concerns a single part of the aggregate price of the Products, the warranty shall not apply.

7.5 Without prejudice to the compulsory product's liability law and any liability for willful misconduct and/or gross negligence, PBA shall not be liable for direct, indirect or incidental damages caused to the Client and and/or to third parties as a consequence of the defects of the Products. The Client shall not be entitled to terminate the Agreement in case of vices and/or defects of the Products subject matter of this warranty, should PBA timely comply with the relevant obligations.

7.6 The Products made of wood, pvc, rubber, rolled sections and/or of other natural materials shall be of a quality equal, within the limits of a reasonable similarity, to the relevant samples examined by the Client before the execution of the Agreement.

In no case shall therefore the samples of the Products examined by the Client be qualified as the exclusive standard for the exterior appearance of the Products.

Without prejudice to the warranty regulated by this clause 7, any chromatic and/or aesthetic difference (nervation of the wood, intensity of the colour shades, etc.) of the delivered Products compared to the characteristics of the relevant samples examined by the Client, shall not entitle the latter to terminate the Agreement and/or to ask for the replacement of the Products or for the reduction of the price.

7.7 In no event shall the chromatic differences between Products of the same type and/or colour, delivered with different lots and/or in different moments, be qualified as vices and/or defects of the Products, nor shall the Client be entitled to claim their replacement and/or the reduction of the relevant price as a consequence thereof.

8. MISPRINTS AND PRINTING ERRORS

We are not responsible for any misprint or printing error in catalogs or price lists. All images and sizes are not binding. Modifications are reserved. Design modifications are reserved to technically enhance products

9. EXCLUSIVE COURT

All disputes arising out of or relating to these General Conditions, any Agreement and/or to the supply of Products shall be exclusively submitted to and settled by the Court of Vicenza, Italy.

PBA shall in any case be entitled, at its exclusive discretion, to institute legal proceedings against the Client before the Court of the place where the Client has its registered office.

10. APPLICABLE LAW

These General Conditions of sale and any Agreement shall be governed by Italian Law.

Should the Client be a foreign entity or in any case an entity having the registered office or the main place of business abroad, the Contracts related to the supply of the Products shall in any case be regulated by the United Nations Convention on the International Sale of Goods (Wien Convention, April 11, 1980)

11. WAIVER

Failure by PBA to enforce at any time the provisions of these General Conditions shall not be construed as a waiver of such provision or of the right to thereafter enforce each and every provision herein.

12. LANGUAGE

The Client executes these General Conditions in Italian and in English, it being agreed that should any conflict or inconsistency arise among the two versions, the Italian wording shall always prevail.

pba S.p.A.

T +39 0424 5451 info@pba.it www.pba.it

pba USA, Inc.

T +1 212 255 4605 salesusa@pba-usa.us www.pba.it

pba S.p.A. Deutschland

T +49 2151 820060 info@de.pba.it www.pba.it