

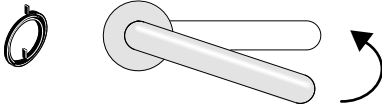

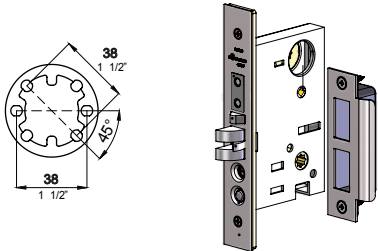















































LEVERS





















AVAILABLE WITH RETURN SPRING



COMPATIBLE WITH US MORTISE LOCK



CODE	MATERIAL	FINISH	.XX	* indicative colors			
2MM.	STAINLESS STEEL AISI 316L	Standard: SATIN	LRV 53	.44			
		BRIGHT	LRV 70	.43			
		Standard: PROGRAMMA PVD	Gold	.81			
		PVD <small>on selected items (*) see catalogue</small>	Black Satin	.83			
		POWDER-COATED	Black Ral 9005 Matt <small>(To match with pba Black Aluminum)</small>	.40			
			Black Ral 9005 Glossy	.26			
			White Ral 9010	.31			
			Grey	.32			
			Champagne	.38			
			Bronze <small>(To match with pba Bronze Aluminum)</small>	.39			
			Architectural Bronze	.36			
			Medium Bronze	.56			
			Silver	.41			
			Gold	.55			
		COLORS ON REQUEST TO MATCH ANY RAL #		.99			
		<small>Screws, grub screws and plastic parts non powder-coated. Available on request depending on quantities.</small>					
		YOD.	STAINLESS STEEL AISI 316L + WOOD	Standard: SATIN + WOOD	Wenge	.46	
				Ash	.47		
				Mahogany	.48		
				Bleached white oak	.52		
BRIGHT+ WOOD	Wenge			.49			
	Ash			.50			
	Mahogany			.51			
	Bleached white oak			.53			
POWDER-COATED	Black Ral 9005 Matt <small>(To match with pba Black Aluminum)</small>			.40			
	Black Ral 9005 Glossy			.26			
	White Ral 9010			.31			
	Grey			.32			
	Champagne			.38			
	Bronze <small>(To match with pba Bronze Aluminum)</small>			.39			
	Architectural Bronze			.36			
	Medium Bronze			.56			
	Silver			.41			
	Gold			.55			
	White/Bleached White Oak			.31			
	Black/Wenge			.40			
	COLORS ON REQUEST TO MATCH ANY RAL #		.99				
	<small>Screws, grub screws and plastic parts non powder-coated. Available on request depending on quantities.</small>						
		STAINLESS STEEL AISI 316L + LEATHER	Standard: SATIN	Black PF	.4H		
+ LEATHER			Brown PF	.4P			
BRIGHT			Black PF	.3H			
			Brown PF	.3P			
POWDER-COATED			Black Ral 9005 Matt <small>(To match with pba Black Aluminum)</small>	.40			
			Black Ral 9005 Glossy	.26			
			White Ral 9010	.31			
			Grey	.32			
			Champagne	.38			
			Bronze <small>(To match with pba Bronze Aluminum)</small>	.39			
	Architectural Bronze	.36					
	Medium Bronze	.56					
	Silver	.41					
	Gold	.55					
White/Leather White	.31						
Black/Leather Black	.40						
COLORS ON REQUEST TO MATCH ANY RAL #		.99					
<small>Screws, grub screws and plastic parts non powder-coated. Available on request depending on quantities.</small>							

CODE	MATERIAL	FINISH	.XX	* indicative colors				
2MH.	STAINLESS STEEL AISI 316L + LEATHER + WOOD	Standard: POWDER-COATED	White	.31				
			Black	.40				
		+ LEATHER	White/White	.31				
		+ LEATHER	Black/Black	.40				
	+ WOOD	White/ Bleached White oak	.31					
	+ WOOD	Black/Wenge	.40					
2MU.	STAINLESS STEEL AISI 316L + COPPER	Standard: SATIN + SATIN COPPER		.4R				
STA.	STAINLESS STEEL AISI 316L + ALUMINUM	Standard: SATIN + ALUMINUM	Silver	.4K				
			Bronze	.4M				
			Black	.4N				
			BRIGHT + ALUMINUM	Silver	.3K			
		Bronze	.3M					
		Black	.3N					
2AM.	ALUMINUM	Standard: ANODIZED SATIN	Silver	.69				
			Bronze	.67				
			Black	.68				
			Champagne <small>(only on selected articles)</small>	.66				
3CC.	POLYAMIDE 6	Standard:	Black	LRV 5	.10			
			Upon Request: <small>(minimum lot to be agreed)</small>		White	LRV 87	.01	
			Grey	LRV 27	.07			
			Red	LRV 9	.09			



Programma 2000
Stainless Steel
2MM.030.XXXX.xx
page Levers_8



HEAVY-USE
Programma 2000
Stainless Steel
2MM.30S.XXXX.xx
page Levers_12



SATIN+BRIGHT
Programma 2000
Stainless Steel
2MM.030.XXXX.45
page Levers_15



Programma YOD
Stainless Steel - Wood
YOD.003.XXXX.xx
page Levers_18



Programma YOD
Stainless Steel Powder-coated - Wood
2MH.030.UWT8.31
page Levers_21



Programma YOD
Stainless Steel Powder-coated - Wood
2MH.030.UWT8.40
page Levers_21



Programma YOD
Stainless Steel - Leather
YOD.030.XXXX.xx
page Levers_23



Programma YOD
Stainless Steel Powder-coated - Leather
2MH.030.ULT8.31
page Levers_26



Programma YOD
Stainless Steel Powder-coated - Leather
2MH.030.ULT8.40
page Levers_26



Programma CU
Satin Stainless Steel - Copper
2MU.030.XXXX.xx
page Levers_28



Programma ALUMINUM
Aluminum
2AM.030.XXXX.xx
page Levers_30



Programma ALUMINUM
Aluminum - Leather
2AM.030.ULT8.68
page Levers_32



Programma ALUMINUM
Aluminum
2AM.001.XXXX.xx
page Levers_34



Programma 2000
2MM.30B.XXXX.xx
Stainless Steel
page Levers_36



Programma 2000
Stainless Steel
2MM.028.XXXX.xx
page Levers_38



Programma YOD
Stainless Steel - Leather
YOD.028.XXXX.xx
page Levers_42



Programma CU
Satin Stainless Steel - Copper
2MU.028.XXXX.xx
page Levers_45



Programma 2000
2MM.28B.0000.xx
Stainless Steel
page Levers_47



Programma 300
Polyamide 6
3CC.326.XXXX.xx
page Levers_51



Programma 2000
Stainless Steel
2MM.173.XXXX.xx
page Levers_54



Programma ALUMINUM
Aluminum
2AM.173.XXXX.xx
page Levers_56



Programma ALUMINUM
Aluminum - Leather
2AM.173.ULT8.68
page Levers_58



Programma 2000
Stainless Steel
2MM.026.XXXX.xx
page Levers_60



Programma 2000
Stainless Steel
2MM.027.XXXX.xx
page Levers_64



Programma 2000
Stainless Steel
2MM.170.XXXX.xx
page Levers_68



Programma IT
Stainless Steel
0IT.151.XXXX.xx
page Levers_72



Programma IT
Stainless Steel
0IT.152.XXXX.xx
page Levers_75



Programma IT
Stainless Steel
0IT.153.XXXX.xx
page Levers_78



Programma 2000
Stainless Steel
2MM.020.XXXX.xx
page Levers_81



Programma 2000
Stainless Steel
2MM.20S.XXXX.xx
page Levers_85



Programma 2000
Stainless Steel
2MM.015.XXXX.xx
page Levers_88



Programma 2000
Stainless Steel
2MM.171.XXXX.xx
page Levers_92



Programma 2000
Stainless Steel
2MM.022.XXXX.xx
page Levers_96



Programma 2000
Stainless Steel
2MM.172.XXXX.xx
page Levers_100



Programma 2000
Stainless Steel
2MM.175.XXXX.xx
page Levers_104



Programma 2000
Stainless Steel
2MM.174.XXXX.xx
page Levers_106



Programma YOD
Stainless Steel - Wood
YOD.001.XXXX.xx
page Levers_108



Programma STEELALU
Stainless Steel - Aluminum
STA.001.0UT8.xx
page Levers_111



Programma STEELALU
Stainless Steel - Aluminum
STA.002.0UT8.xx
page Levers_113



Programma STEELALU
Stainless Steel - Aluminum
STA.003.0UT8.xx
page Levers_115



Programma YOD
Stainless Steel - Wood
YOD.002.XXXX.xx
page Levers_117



Programma STEELALU
Stainless Steel - Aluminum
STA.004.0UT8.xx
page Levers_120



Programma STEELALU
Stainless Steel - Aluminum
STA.005.0UT8.xx
page Levers_122



Programma STEELALU
Stainless Steel - Aluminum
STA.006.0UT8.xx
page Levers_124

LEGEND
page 1

THUMBTURNS
page Levers_126

ACCESSORIES
page Levers_132

TECHNICAL REFERENCES
page Levers_137





ITEM

2MM.030.xxxx.xx











MATERIALS, FINISHING AND DETAILS

.XX = FINISH CODE

STAINLESS STEEL

- .44 SATIN STAINLESS STEEL (ANSI/BHMA 630 - USD32D) 
- .43 BRIGHT STAINLESS STEEL (ANSI/BHMA 629 - USD32) 

STAINLESS STEEL POWDER-COATED

- .40 BLACK RAL 9005 MATT - TO MATCH WITH PBA 
- .26 BLACK ALUMINUM 
- .31 WHITE RAL 9005 GLOSSY 
- .32 GREY 
- .38 CHAMPAGNE 
- .39 BRONZE - TO MATCH WITH PBA BRONZE ALUMINUM 
- .36 ARCHITECTURAL BRONZE 
- .56 MEDIUM BRONZE 
- .41 SILVER 
- .55 GOLD 
- .99 COLORS ON REQUEST TO MATCH ANY RAL #
(screws, grub screws and plastic parts non powder-coated).
Available on request depending on quantities.

PVD ON SELECTED ITEMS

- .83 BLACK SATIN 
Colors on demand, minimum lot to be agreed.
Screws and grub screws not pvd.

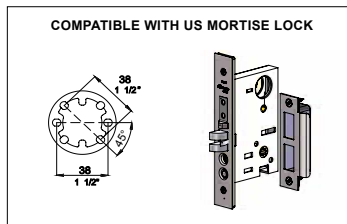
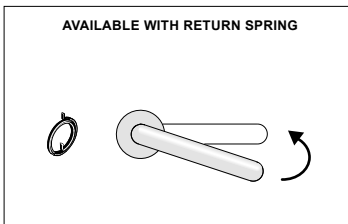

THESE PRODUCTS CONTRIBUTE TO **LEED** CREDITS

THE MANUFACTURER RESERVES THE RIGHT TO ALTER, IMPROVE AND DISCONTINUE ANY FEATURES OF THE PRODUCT (MAKE CHANGES AND IMPROVEMENTS IN DESIGNS AND DIMENSIONS) WITHOUT NOTICE.

ALL DIMENSIONS IN THE CATALOG DRAWINGS ARE APPROXIMATIONS. REQUEST THE APPROPRIATE TECHNICAL DRAWING BEFORE DOOR PREPARATION AND INSTALLATION.

FIXING:

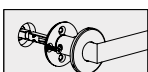

SINGLE SIDE FIXING

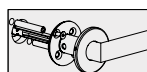

BACK TO BACK FIXING

HANDLE FOR MORTISE
WOOD OR HM DOORS



Ø 20



ITEM THESE PRODUCTS CONTRIBUTE TO LEED® CREDITS **Declare.**

2MM.030.0UT8 . xx



with return spring

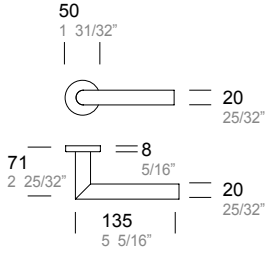

2MM.030.00T4 . xx



without return spring

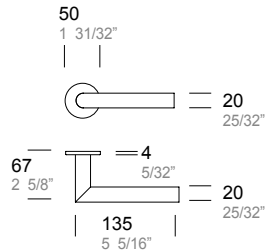

2MM.030.0Uxx . xx



without return spring

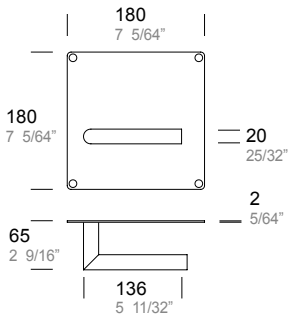

2MM.030.0Uxx . xx

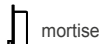

without return spring

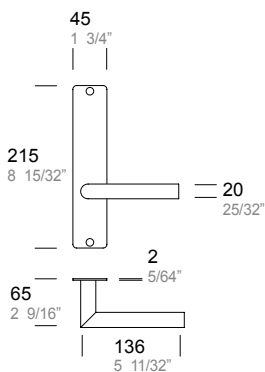

LOCK
WOOD OR HM DOORS



+



Ø 20

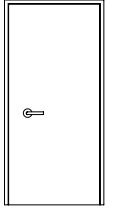

FUNCTION BACKSET HOW TO ORDER

PASSAGE ANSI F01 2 1/2" 2 3/4" 2MM.LCK.0A00 . xx + ONLY LOCK 2MM.030.0xTx . xx

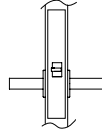

+ 2MM.030.0Uxx . xx

+ 2MM.030.0Uxx . xx

OFFICE/CORRIDOR ANSI F04 2 1/2" 2 3/4" 2MM.LCK.0F00 . xx + ONLY LOCK 2MM.030.0xTx . xx

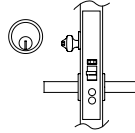

+ 2MM.030.0Uxx . xx

+ 2MM.030.0Uxx . xx

CLASSROOM ANSI F05 2 1/2" 2 3/4" 2MM.LCK.0G00 . xx + ONLY LOCK 2MM.030.0xTx . xx

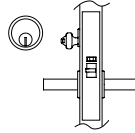

+ 2MM.030.0Uxx . xx

+ 2MM.030.0Uxx . xx

STOREROOM ANSI F07 2 1/2" 2 3/4" 2MM.LCK.0P00 . xx + ONLY LOCK 2MM.030.0xTx . xx

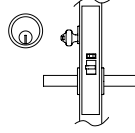

+ 2MM.030.0Uxx . xx

+ 2MM.030.0Uxx . xx

OFFICE/ENTRY ANSI F04 + F13 2 1/2" 2 3/4" 2MM.LCK.0I00 . xx + ONLY LOCK 2MM.030.0xTx . xx

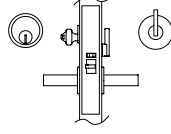

+ Add thumbturns page Levers_127

+ 2MM.030.0Uxx . xx

+ Add thumbturns page Levers_127

+ 2MM.030.0Uxx . xx

+ Add thumbturns page Levers_127

+ 2MM.030.0Uxx . xx

+ Add thumbturns page Levers_127

+ 2MM.030.0Uxx . xx

+ Add thumbturns page Levers_127

+ 2MM.030.0Uxx . xx

.XX = FINISH CODE

- STAINLESS STEEL
- .43 BRIGHT STAINLESS STEEL (ANSI/BHMA 629 - USD32)
- .44 SATIN STAINLESS STEEL (ANSI/BHMA 630 - USD32D)

PVD ON REQUEST

- .83 BLACK SATIN
- Colors on demand, minimum lot to be agreed.
- Screws and grub screws not pvd

STAINLESS STEEL POWDER-COATED ON REQUEST

- .40 BLACK RAL 9005 MATT - TO MATCH WITH PBA BLACK ALUMINUM
- .26 BLACK RAL 9005 GLOSSY
- .31 WHITE RAL 9010
- .32 GREY
- .38 CHAMPAGNE
- .39 BRONZE - TO MATCH WITH PBA BRONZE ALUMINUM
- .36 ARCHITECTURAL BRONZE
- .56 MEDIUM BRONZE
- .41 SILVER
- .55 GOLD

- .99 COLORS ON REQUEST TO MATCH ANY RAL # (screws, grub screws and plastic parts non powder-coated) available on request depending on quantities

MORTISE LOCKS: SEE TECHNICAL INFORMATION FOR SOLID DOOR SECTION

MORTISE CYLINDERS NOT INCLUDED see page Levers_141 FOR COMPATIBLE MODELS

STANDARD FACEPLATE AND STRIKEPLATE SATIN STAINLESS STEEL.

SPINDLE DEPTH, LEVERS POSITION ON THE LOCKSET AND FIXING (SINGLE OR BACK TO BACK) MUST BE SPECIFIED ORDERING - see page Levers_143

HANDLE FOR MORTISE

GLASS DOORS WITH ALUMINUM PROFILE OR WOOD AND HM DOORS



Declare.

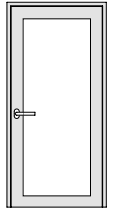

ITEM THESE PRODUCTS CONTRIBUTE TO LEED® CREDITS

2MM.030.0008 . xx

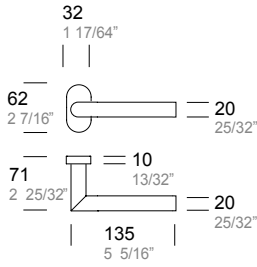

with return spring

2MM.030.0004 . xx

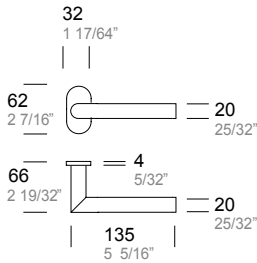

without return spring

.XX = FINISH CODE

- STAINLESS STEEL**
- .43 BRIGHT STAINLESS STEEL (ANSI/BHMA 629 - USD32)
 - .44 SATIN STAINLESS STEEL (ANSI/BHMA 630 - USD32D)

- PVD ON REQUEST**
- .83 BLACK SATIN
- Colors on demand, minimum lot to be agreed.
Screws and grub screws not pvd

STAINLESS STEEL POWDER-COATED ON REQUEST

- .40 BLACK RAL 9005 MATT - TO MATCH WITH PBA BLACK ALUMINUM
- .26 BLACK RAL 9005 GLOSSY
- .31 WHITE RAL 9010
- .32 GREY
- .38 CHAMPAGNE
- .39 BRONZE - TO MATCH WITH PBA BRONZE ALUMINUM
- .36 ARCHITECTURAL BRONZE
- .56 MEDIUM BRONZE
- .41 SILVER
- .55 GOLD

- .99 COLORS ON REQUEST TO MATCH ANY RAL # (screws, grub screws and plastic parts non powder-coated) available on request depending on quantities

SPINDLE DEPTH, LEVERS POSITION ON THE LOCKSET AND FIXING (SINGLE OR BACK TO BACK) MUST BE SPECIFIED ORDERING - see page Levers_143

HANDLE WITH LATCH
WOOD OR HM DOORS



ITEM BACKSET FUNCTION

2MM.030.SA70 . xx	70 mm 2 3/4"	PASSAGE	
2MM.030.SA60 . xx	60 mm 2 3/8"		
latch included			
with return spring			

2MM.030.SB70 . xx	70 mm 2 3/4"	PRIVACY	
2MM.030.SB60 . xx	60 mm 2 3/8"		
latch included			
with return spring			

2MM.030.MA70 . xx	70 mm 2 3/4"	PASSAGE WITH MAGNETIC BOLT	
2MM.030.MA60 . xx	60 mm 2 3/8"		
latch included			
with return spring			

2MM.030.MB70 . xx	70 mm 2 3/4"	PRIVACY WITH MAGNETIC BOLT	
2MM.030.MB60 . xx	60 mm 2 3/8"		
latch included			
with return spring			

.XX = FINISH CODE

- STAINLESS STEEL
- .43 BRIGHT STAINLESS STEEL (ANSI/BHMA 629 - USD32)
- .44 SATIN STAINLESS STEEL (ANSI/BHMA 630 - USD32D)
- PVD ON REQUEST
- .83 BLACK SATIN
- Colors on demand, minimum lot to be agreed.
- Screws and grub screws not pvd

- STAINLESS STEEL POWDER-COATED ON REQUEST
- .40 BLACK RAL 9005 MATT. TO MATCH WITH PBA BLACK ALUMINUM
- .26 BLACK RAL 9005 GLOSSY
- .31 WHITE RAL 9010
- .32 GREY
- .38 CHAMPAGNE
- .39 BRONZE - TO MATCH WITH PBA BRONZE ALUMINUM
- .36 ARCHITECTURAL BRONZE
- .56 MEDIUM BRONZE
- .41 SILVER
- .55 GOLD

- .99 COLORS ON REQUEST TO MATCH ANY RAL #
- (screws, grub screws and plastic parts non powder-coated)
- available on request depending on quantities

LATCH DETAILS
page Levers_145

HANDLE DUMMY
WOOD OR HM DOORS

THESE PRODUCTS CONTRIBUTE TO LEED® CREDITS



ITEM

2MM.030.0D06 . xx	SINGLE	
2MM.030.C0D6 . xx	PAIR	
dummy		
without return spring		

2MM.030.0D05 . xx	SINGLE	
2MM.030.C0D5 . xx	PAIR	
dummy		
without return spring		



**HEAVY
U S E**



ITEM

2MM.30S.xxxx.xx

MATERIALS, FINISHING AND DETAILS

.XX = FINISH CODE

STAINLESS STEEL

- .44 SATIN STAINLESS STEEL (ANSI/BHMA 630 - USD32D) 
- .43 BRIGHT STAINLESS STEEL (ANSI/BHMA 629 - USD32) 

STAINLESS STEEL POWDER-COATED

- .40 BLACK RAL 9005 MATT - TO MATCH WITH PBA 
- .26 BLACK ALUMINUM 
- .31 WHITE RAL 9005 GLOSSY 
- .32 GREY 
- .38 CHAMPAGNE 
- .39 BRONZE - TO MATCH WITH PBA BRONZE ALUMINUM 
- .36 ARCHITECTURAL BRONZE 
- .56 MEDIUM BRONZE 
- .41 SILVER 
- .55 GOLD 
- .99 COLORS ON REQUEST TO MATCH ANY RAL #
(screws, grub screws and plastic parts non powder-coated).
Available on request depending on quantities.

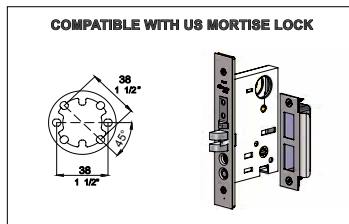

THESE PRODUCTS CONTRIBUTE TO **LEED**® CREDITS

THE MANUFACTURER RESERVES THE RIGHT TO ALTER, IMPROVE AND DISCONTINUE ANY FEATURES OF THE PRODUCT (MAKE CHANGES AND IMPROVEMENTS IN DESIGNS AND DIMENSIONS) WITHOUT NOTICE.

ALL DIMENSIONS IN THE CATALOG DRAWINGS ARE APPROXIMATIONS. REQUEST THE APPROPRIATE TECHNICAL DRAWING BEFORE DOOR PREPARATION AND INSTALLATION.

FIXING:

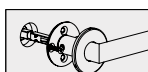

SINGLE SIDE FIXING

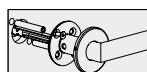

BACK TO BACK FIXING

HANDLE FOR MORTISE
WOOD OR HM DOORS



**HEAVY
U S E**



Declare.

ITEM THESE PRODUCTS CONTRIBUTE TO LEED® CREDITS

2MM.30S.0UT8 . xx



with return spring

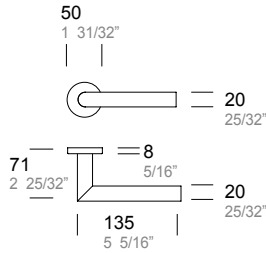

2MM.30S.00T4 . xx

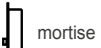

without return spring

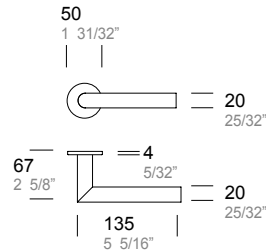

2MM.30S.0Uxx . xx

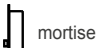

without return spring

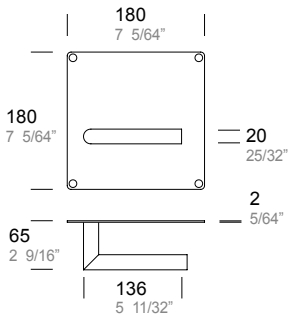

2MM.30S.0Uxx . xx



without return spring

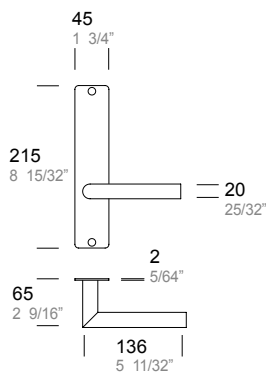

LOCK
WOOD OR HM DOORS



+



**HEAVY
U S E**

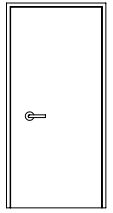

FUNCTION	BACKSET	HOW TO ORDER
PASSAGE ANSI F01	2 1/2" 2 3/4"	2MM.LCK.0A00 . xx + 2MM.30S.0xTx . xx ONLY LOCK + 2MM.30S.0Uxx . xx + 2MM.30S.0Uxx . xx
OFFICE/CORRIDOR ANSI F04	2 1/2" 2 3/4"	2MM.LCK.0F00 . xx + 2MM.30S.0xTx . xx ONLY LOCK + 2MM.30S.0Uxx . xx + 2MM.30S.0Uxx . xx
CLASSROOM ANSI F05	2 1/2" 2 3/4"	2MM.LCK.0G00 . xx + 2MM.30S.0xTx . xx ONLY LOCK + 2MM.30S.0Uxx . xx + 2MM.30S.0Uxx . xx
STOREROOM ANSI F07	2 1/2" 2 3/4"	2MM.LCK.0P00 . xx + 2MM.30S.0xTx . xx ONLY LOCK + 2MM.30S.0Uxx . xx + 2MM.30S.0Uxx . xx
OFFICE/ENTRY ANSI F04 + F13	2 1/2" 2 3/4"	2MM.LCK.0I00 . xx + 2MM.30S.0xTx . xx ONLY LOCK + 2MM.30S.0Uxx . xx . xx . x Add thumbturns page Levers_127 + 2MM.30S.0Uxx . xx . xx . x Add thumbturns page Levers_127 + 2MM.30S.0Uxx . xx . xx . x Add thumbturns page Levers_127
DORMITORY ANSI F13	2 1/2" 2 3/4"	2MM.LCK.0E00 . xx + 2MM.30S.0xTx . xx ONLY LOCK + 2MM.30S.0Uxx . xx Add thumbturns page Levers_127 + 2MM.30S.0Uxx . xx Add thumbturns page Levers_127 + 2MM.30S.0Uxx . xx Add thumbturns page Levers_127
PRIVACY ANSI F19	2 1/2" 2 3/4"	2MM.LCK.0M00 . xx + 2MM.30S.0xTx . xx ONLY LOCK + 2MM.30S.0Uxx . xx Add thumbturns page Levers_127 + 2MM.30S.0Uxx . xx Add thumbturns page Levers_127 + 2MM.30S.0Uxx . xx Add thumbturns page Levers_127

.XX = FINISH CODE

- STAINLESS STEEL**
- .43 BRIGHT STAINLESS STEEL (ANSI/BHMA 629 - USD32)
- .44 SATIN STAINLESS STEEL (ANSI/BHMA 630 - USD32D)
- .99 COLORS ON REQUEST TO MATCH ANY RAL #
(screws, grub screws and plastic parts non powder-coated)
available on request depending on quantities

- STAINLESS STEEL POWDER-COATED ON REQUEST**
- .40 BLACK RAL 9005 MATT - TO MATCH WITH PBA BLACK ALUMINUM
- .26 BLACK RAL 9005 GLOSSY
- .31 WHITE RAL 9010
- .32 GREY
- .38 CHAMPAGNE
- .39 BRONZE - TO MATCH WITH PBA BRONZE ALUMINUM
- .36 ARCHITECTURAL BRONZE
- .56 MEDIUM BRONZE
- .41 SILVER
- .55 GOLD

MORTISE LOCKS: SEE TECHNICAL INFORMATION FOR SOLID DOOR SECTION
MORTISE CYLINDERS NOT INCLUDED see page Levers_141
FOR COMPATIBLE MODELS
STANDARD FACEPLATE AND STRIKEPLATE SATIN STAINLESS STEEL.
SPINDLE DEPTH, LEVERS POSITION ON THE LOCKSET AND FIXING
(SINGLE OR BACK TO BACK) MUST BE SPECIFIED ORDERING - see page Levers_143

HANDLE FOR MORTISE
GLASS DOORS WITH ALUMINUM PROFILE
OR WOOD AND HM DOORS



**HEAVY
U S E**



Declare.

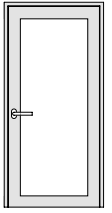

ITEM THESE PRODUCTS CONTRIBUTE TO **LEED®** CREDITS

2MM.30S.0008 . xx

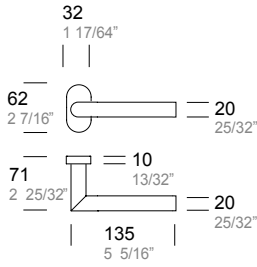

Ø with return spring

2MM.30S.0004 . xx

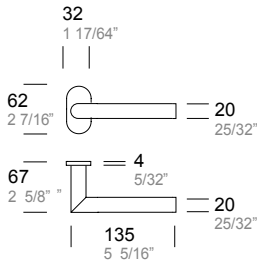

Ø without return spring

.XX = FINISH CODE

- STAINLESS STEEL**
- .43 BRIGHT STAINLESS STEEL (ANSI/BHMA 629 - USD32)
- .44 SATIN STAINLESS STEEL (ANSI/BHMA 630 - USD32D)

- .99 COLORS ON REQUEST TO MATCH ANY RAL #
(screws, grub screws and plastic parts non powder-coated)
available on request depending on quantities

- STAINLESS STEEL POWDER-COATED ON REQUEST**
- .40 BLACK RAL 9005 MATT - TO MATCH WITH PBA BLACK ALUMINUM
- .26 BLACK RAL 9005 GLOSSY
- .31 WHITE RAL 9010
- .32 GREY
- .38 CHAMPAGNE
- .39 BRONZE - TO MATCH WITH PBA BRONZE ALUMINUM
- .36 ARCHITECTURAL BRONZE
- .56 MEDIUM BRONZE
- .41 SILVER
- .55 GOLD

SPINDLE DEPTH, LEVERS POSITION ON THE LOCKSET AND FIXING
(SINGLE OR BACK TO BACK) MUST BE SPECIFIED ORDERING - see page Levers_143



ITEM

2MM.030.xxxx.45

MATERIALS, FINISHING AND DETAILS

FINISH CODE

STAINLESS STEEL

.45 SATIN STAINLESS STEEL (ANSI/BHMA 630 - USD32D) + BRIGHT STAINLESS STEEL (ANSI/BHMA 629 - USD32)

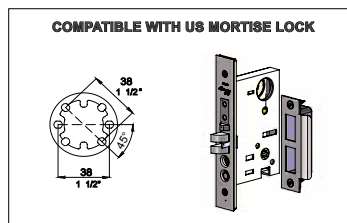

THESE PRODUCTS CONTRIBUTE TO **LEED®** CREDITS

THE MANUFACTURER RESERVES THE RIGHT TO ALTER, IMPROVE AND DISCONTINUE ANY FEATURES OF THE PRODUCT (MAKE CHANGES AND IMPROVEMENTS IN DESIGNS AND DIMENSIONS) WITHOUT NOTICE.

ALL DIMENSIONS IN THE CATALOG DRAWINGS ARE APPROXIMATIONS. REQUEST THE APPROPRIATE TECHNICAL DRAWING BEFORE DOOR PREPARATION AND INSTALLATION.

FIXING:

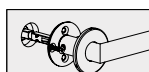

SINGLE SIDE FIXING

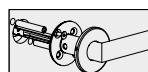

BACK TO BACK FIXING

HANDLE FOR MORTISE
WOOD OR HM DOORS



ITEM THESE PRODUCTS CONTRIBUTE TO LEED® CREDITS

2MM.030.0UT8.45

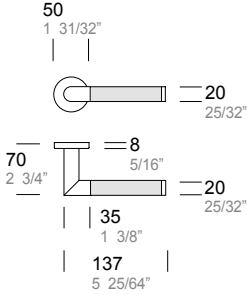

- mortise
- with return spring

2MM.030.00T4.45

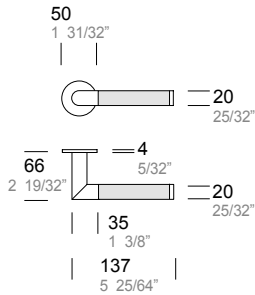

- mortise
- without return spring

- BRIGHT STAINLESS STEEL
- SATIN STAINLESS STEEL

LOCK
WOOD OR HM DOORS

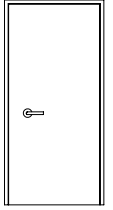

FUNCTION	BACKSET	HOW TO ORDER
PASSAGE ANSI F01 	2 1/2" 2 3/4"	2MM.LCK.0A00 . xx + 2MM.030.0xTx.45 ONLY LOCK
OFFICE/CORRIDOR ANSI F04 	2 1/2" 2 3/4"	2MM.LCK.0F00 . xx + 2MM.030.0xTx.45 ONLY LOCK
CLASSROOM ANSI F05 	2 1/2" 2 3/4"	2MM.LCK.0G00 . xx + 2MM.030.0xTx.45 ONLY LOCK
STOREROOM ANSI F07 	2 1/2" 2 3/4"	2MM.LCK.0P00 . xx + 2MM.030.0xTx.45 ONLY LOCK
OFFICE/ENTRY ANSI F04 + F13 	2 1/2" 2 3/4"	2MM.LCK.0I00 . xx + 2MM.030.0xTx.45 ONLY LOCK Add thumbturns page Levers_127
DORMITORY ANSI F13 	2 1/2" 2 3/4"	2MM.LCK.0E00 . xx + 2MM.030.0xTx.45 ONLY LOCK Add thumbturns page Levers_127
PRIVACY ANSI F19 	2 1/2" 2 3/4"	2MM.LCK.0M00 . xx + 2MM.030.0xTx.45 ONLY LOCK Add thumbturns page Levers_127

FINISH CODE

- .45 STAINLESS STEEL
BRIGHT STAINLESS STEEL (ANSI/BHMA 629 - USD32) + SATIN STAINLESS STEEL (ANSI/BHMA 630 - USD32D)

MORTISE LOCKS: SEE TECHNICAL INFORMATION FOR SOLID DOOR SECTION
MORTISE CYLINDERS NOT INCLUDED see page Levers_141
FOR COMPATIBLE MODELS
STANDARD FACEPLATE AND STRIKEPLATE SATIN STAINLESS STEEL.
SPINDLE DEPTH, LEVERS POSITION ON THE LOCKSET AND FIXING
(SINGLE OR BACK TO BACK) MUST BE SPECIFIED ORDERING - see page Levers_143

HANDLE FOR MORTISE

GLASS DOORS WITH ALUMINUM PROFILE
OR WOOD AND HM DOORS

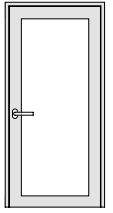

ITEM THESE PRODUCTS CONTRIBUTE TO **LEED®** CREDITS



2MM.030.0008.45

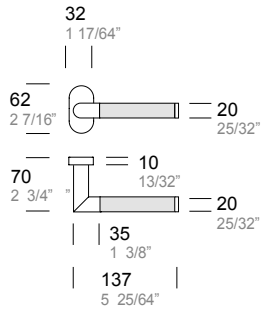

with return spring

2MM.030.0004.45

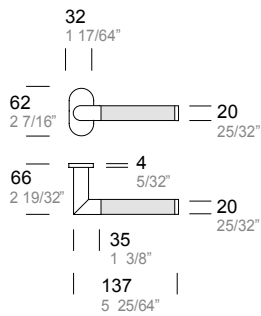

without return spring

- BRIGHT STAINLESS STEEL
- SATIN STAINLESS STEEL

FINISH CODE

.45 STAINLESS STEEL
BRIGHT STAINLESS STEEL (ANSI/BHMA 629 - USD32) + SATIN STAINLESS STEEL (ANSI/BHMA 630 - USD32D)

SPINDLE DEPTH, LEVERS POSITION ON THE LOCKSET AND FIXING
(SINGLE OR BACK TO BACK) MUST BE SPECIFIED ORDERING - see page Levers_143



ITEM

YOD.003.xxxx.xx

MATERIALS, FINISHING AND DETAILS

.XX = FINISH CODE

	MATT CLEAR COATED WOOD	STAINLESS STEEL	
.46	WENGÈ	SATIN STAINLESS STEEL (ANSI/BHMA 630 - USD32D)	
.49	WENGÈ	BRIGHT STAINLESS STEEL (ANSI/BHMA 629 - USD32)	
.47	ASH	SATIN STAINLESS STEEL (ANSI/BHMA 630 - USD32D)	
.50	ASH	BRIGHT STAINLESS STEEL (ANSI/BHMA 629 - USD32)	
.48	MAHOGANY	SATIN STAINLESS STEEL (ANSI/BHMA 630 - USD32D)	
.51	MAHOGANY	BRIGHT STAINLESS STEEL (ANSI/BHMA 629 - USD32)	
.52	BLEACHED WHITE OAK	SATIN STAINLESS STEEL (ANSI/BHMA 630 - USD32D)	
.53	BLEACHED WHITE OAK	BRIGHT STAINLESS STEEL (ANSI/BHMA 629 - USD32)	

STAINLESS STEEL POWDER-COATED

.40	BLACK RAL 9005 MATT - TO MATCH WITH PBA	
.26	BLACK ALUMINUM	
.31	WHITE RAL 9005 GLOSSY	
.32	GREY	
.38	CHAMPAGNE	
.39	BRONZE - TO MATCH WITH PBA BRONZE ALUMINUM	
.36	ARCHITECTURAL BRONZE	
.56	MEDIUM BRONZE	
.41	SILVER	
.55	GOLD	

.99 COLORS ON REQUEST TO MATCH ANY RAL # (screws, grub screws and plastic parts non powder-coated). Available on request depending on quantities.

PVD ON SELECTED ITEMS

.83	BLACK SATIN Colors on demand, minimum lot to be agreed. Screws and grub screws not pvd.	
------------	--	--

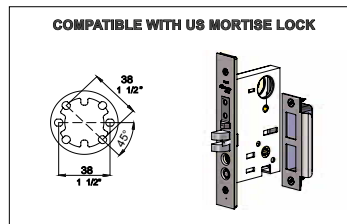

THESE PRODUCTS CONTRIBUTE TO LEED® CREDITS

THE MANUFACTURER RESERVES THE RIGHT TO ALTER, IMPROVE AND DISCONTINUE ANY FEATURES OF THE PRODUCT (MAKE CHANGES AND IMPROVEMENTS IN DESIGNS AND DIMENSIONS) WITHOUT NOTICE.

ALL DIMENSIONS IN THE CATALOG DRAWINGS ARE APPROXIMATIONS. REQUEST THE APPROPRIATE TECHNICAL DRAWING BEFORE DOOR PREPARATION AND INSTALLATION.

FIXING:

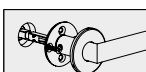

SINGLE SIDE FIXING

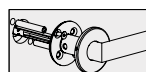

BACK TO BACK FIXING

HANDLE FOR MORTISE
WOOD OR HM DOORS



ITEM THESE PRODUCTS CONTRIBUTE TO LEED® CREDITS

YOD.003.0UT8 . xx



with return spring

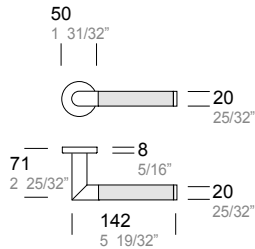

YOD.003.00T4 . xx



without return spring

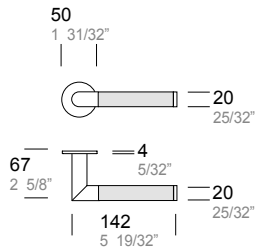

YOD.003.0Uxx . xx



without return spring

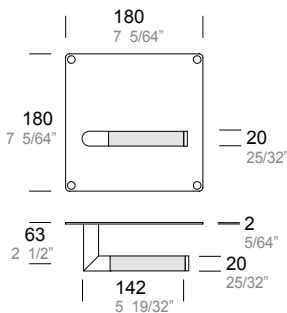

YOD.003.0Uxx . xx



without return spring

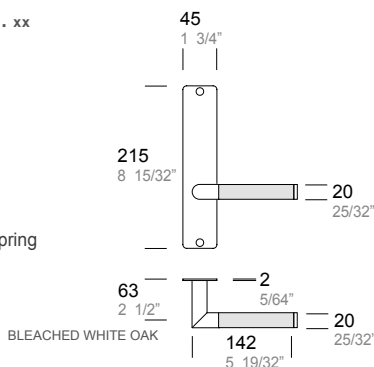

LOCK
WOOD OR HM DOORS

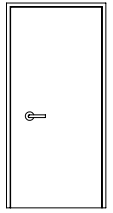
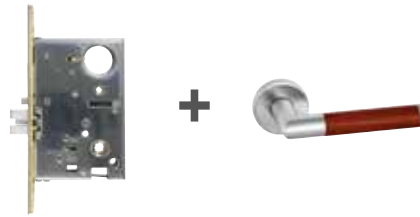

FUNCTION BACKSET HOW TO ORDER

FUNCTION	BACKSET	HOW TO ORDER
PASSAGE ANSI F01	2 1/2" 2 3/4"	2MM.LCK.0A00 . xx + ONLY LOCK + YOD.003.0Tx . xx + YOD.003.0Uxx . xx + YOD.003.0Uxx . xx
OFFICE/CORRIDOR ANSI F04	2 1/2" 2 3/4"	2MM.LCK.0F00 . xx + ONLY LOCK + YOD.003.0Tx . xx + YOD.003.0Uxx . xx + YOD.003.0Uxx . xx
CLASSROOM ANSI F05	2 1/2" 2 3/4"	2MM.LCK.0G00 . xx + ONLY LOCK + YOD.003.0Tx . xx + YOD.003.0Uxx . xx + YOD.003.0Uxx . xx
STOREROOM ANSI F07	2 1/2" 2 3/4"	2MM.LCK.0P00 . xx + ONLY LOCK + YOD.003.0Tx . xx + YOD.003.0Uxx . xx + YOD.003.0Uxx . xx
OFFICE/ENTRY ANSI F04 + F13	2 1/2" 2 3/4"	2MM.LCK.0I00 . xx + ONLY LOCK + Add thumbturns page Levers_127 YOD.003.0Tx . xx + Add thumbturns page Levers_127 YOD.003.0Uxx . xx + Add thumbturns page Levers_127 YOD.003.0Uxx . xx
DORMITORY ANSI F13	2 1/2" 2 3/4"	2MM.LCK.0E00 . xx + ONLY LOCK + Add thumbturns page Levers_127 YOD.003.0Tx . xx + Add thumbturns page Levers_127 YOD.003.0Uxx . xx + Add thumbturns page Levers_127 YOD.003.0Uxx . xx
PRIVACY ANSI F19	2 1/2" 2 3/4"	2MM.LCK.0M00 . xx + ONLY LOCK + Add thumbturns page Levers_127 YOD.003.0Tx . xx + Add thumbturns page Levers_127 YOD.003.0Uxx . xx + Add thumbturns page Levers_127 YOD.003.0Uxx . xx

.XX = FINISH CODE

MATT CLEAR COATED WOOD

- .46 WENGÉ
- .49 WENGÉ
- .47 ASH
- .50 ASH
- .48 MAHOGANY
- .51 MAHOGANY
- .52 BLEACHED WHITE OAK
- .53 BLEACHED WHITE OAK

STAINLESS STEEL

- SATIN STAINLESS STEEL (ANSI/BHMA 630 - USD32D)
- BRIGHT STAINLESS STEEL (ANSI/BHMA 629 - USD32)
- SATIN STAINLESS STEEL (ANSI/BHMA 630 - USD32D)
- BRIGHT STAINLESS STEEL (ANSI/BHMA 629 - USD32)
- SATIN STAINLESS STEEL (ANSI/BHMA 630 - USD32D)
- BRIGHT STAINLESS STEEL (ANSI/BHMA 629 - USD32)
- SATIN STAINLESS STEEL (ANSI/BHMA 630 - USD32D)
- BRIGHT STAINLESS STEEL (ANSI/BHMA 629 - USD32)

STAINLESS STEEL POWDER-COATED ON REQUEST

- .40 BLACK RAL 9005 MATT - TO MATCH WITH PBA BLACK ALUMINUM
- .26 BLACK RAL 9005 GLOSSY
- .31 WHITE RAL 9010
- .32 GREY
- .38 CHAMPAGNE
- .39 BRONZE - TO MATCH WITH PBA BRONZE ALUMINUM
- .36 ARCHITECTURAL BRONZE
- .56 MEDIUM BRONZE
- .41 SILVER
- .55 GOLD

PVD ON REQUEST

- .83 BLACK SATIN
- Colors on demand, minimum lot to be agreed. Screws and grub screws not pvd

MORTISE LOCKS: SEE TECHNICAL INFORMATION FOR SOLID DOOR SECTION
MORTISE CYLINDERS NOT INCLUDED see page Levers_141
FOR COMPATIBLE MODELS

STANDARD FACEPLATE AND STRIKEPLATE SATIN STAINLESS STEEL.

SPINDLE DEPTH, LEVERS POSITION ON THE LOCKSET AND FIXING (SINGLE OR BACK TO BACK) MUST BE SPECIFIED ORDERING see page Levers_143

HANDLE WITH LATCH
WOOD OR HM DOORS



ITEM BACKSET FUNCTION

YOD.003.SA70 . xx 70 mm 2 3/4" PASSAGE

YOD.003.SA60 . xx 60 mm 2 3/8"

latch included

with return spring

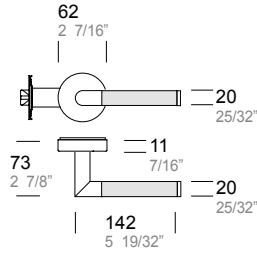

YOD.003.SB70 . xx 70 mm 2 3/4" PRIVACY

YOD.003.SB60 . xx 60 mm 2 3/8"

latch included

with return spring

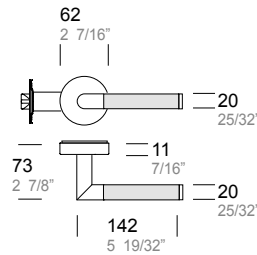

YOD.003.MA70 . xx 70 mm 2 3/4" PASSAGE WITH MAGNETIC BOLT

YOD.003.MA60 . xx 60 mm 2 3/8"

latch included

with return spring

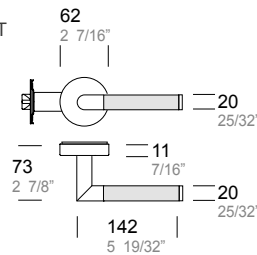

YOD.003.MB70 . xx 70 mm 2 3/4" PRIVACY WITH MAGNETIC BOLT

YOD.003.MB60 . xx 60 mm 2 3/8"

latch included

with return spring

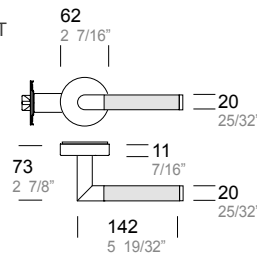

.XX = FINISH CODE

MATT CLEAR COATED WOOD

- .46 WENGÉ
- .49 WENGÉ
- .47 ASH
- .50 ASH
- .48 MAHOGANY
- .51 MAHOGANY
- .52 BLEACHED WHITE OAK
- .53 BLEACHED WHITE OAK

STAINLESS STEEL

- SATIN STAINLESS STEEL (ANSI/BHMA 630 - USD32D)
- BRIGHT STAINLESS STEEL (ANSI/BHMA 629 - USD32)
- SATIN STAINLESS STEEL (ANSI/BHMA 630 - USD32D)
- BRIGHT STAINLESS STEEL (ANSI/BHMA 629 - USD32)
- SATIN STAINLESS STEEL (ANSI/BHMA 630 - USD32D)
- BRIGHT STAINLESS STEEL (ANSI/BHMA 629 - USD32)
- SATIN STAINLESS STEEL (ANSI/BHMA 630 - USD32D)
- BRIGHT STAINLESS STEEL (ANSI/BHMA 629 - USD32)

STAINLESS STEEL POWDER-COATED ON REQUEST

- .40 BLACK RAL 9005 MATT - TO MATCH WITH PBA BLACK ALUMINUM
- .26 BLACK RAL 9005 GLOSSY
- .31 WHITE RAL 9010
- .32 GREY
- .38 CHAMPAGNE
- .39 BRONZE - TO MATCH WITH PBA BRONZE ALUMINUM
- .36 ARCHITECTURAL BRONZE
- .56 MEDIUM BRONZE
- .41 SILVER
- .55 GOLD

THESE PRODUCTS CONTRIBUTE TO LEED® CREDITS

HANDLE DUMMY
WOOD OR HM DOORS



ITEM

YOD.003.0D06 . xx SINGLE

YOD.003.C0D6 . xx PAIR

dummy

without return spring

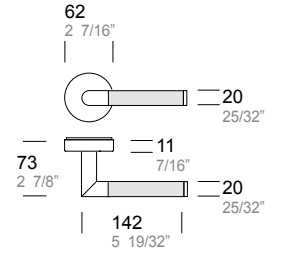

YOD.003.0D05 . xx SINGLE

YOD.003.C0D5 . xx PAIR

dummy

without return spring

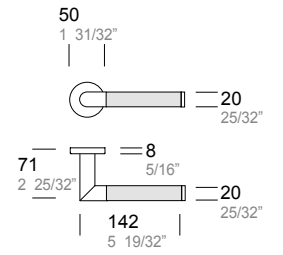

- .83 BLACK SATIN
- Colors on demand, minimum lot to be agreed.
- Screws and grub screws not pvd

PVD ON REQUEST

- .83 BLACK SATIN
- Colors on demand, minimum lot to be agreed.
- Screws and grub screws not pvd
- .99 COLORS ON REQUEST TO MATCH ANY RAL # (screws, grub screws and plastic parts non powder-coated) available on request depending on quantities

LATCH DETAILS
page Levers_145



ITEM

2MH.030.UWT8.xx

MATERIALS, FINISHING AND DETAILS

.XX = FINISH CODE

STAINLESS STEEL POWDER-COATED

.40 BLACK RAL 9005 - TO MATCH WITH PBA BLACK ALUMINIUM

.31 WHITE RAL 9010

MATT CLEAR COATED WOOD

WENGÈ



BLEACHED WHITE OAK



Screws, grub screws and plastic parts non powder-coated.
Available on request depending on quantities.

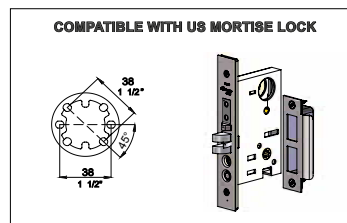

AVAILABLE ON REQUEST AND MINIMUM ORDER

THESE PRODUCTS CONTRIBUTE TO LEED® CREDITS

THE MANUFACTURER RESERVES THE RIGHT TO ALTER, IMPROVE AND DISCONTINUE ANY FEATURES OF THE PRODUCT (MAKE CHANGES AND IMPROVEMENTS IN DESIGNS AND DIMENSIONS) WITHOUT NOTICE.

ALL DIMENSIONS IN THE CATALOG DRAWINGS ARE APPROXIMATIONS. REQUEST THE APPROPRIATE TECHNICAL DRAWING BEFORE DOOR PREPARATION AND INSTALLATION.

FIXING:

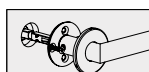

SINGLE SIDE FIXING

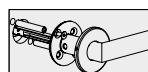

BACK TO BACK FIXING

HANDLE FOR MORTISE
WOOD OR HM DOORS



ITEM THESE PRODUCTS CONTRIBUTE TO LEED® CREDITS

2MH.030.UWT8 . xx

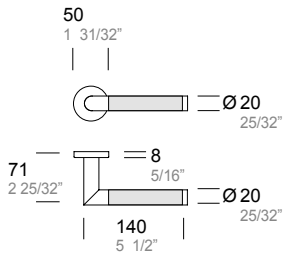
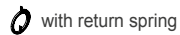

- Matte powder coated
- Wood



LOCK
WOOD OR HM DOORS

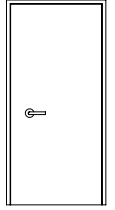

FUNCTION

BACKSET

HOW TO ORDER

PASSAGE
ANSI F01

2 1/2"
2 3/4"

2MM.LCK.0A00 . xx + **ONLY LOCK**

2MH.030.UWT8 . xx

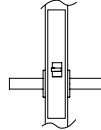

OFFICE/CORRIDOR
ANSI F04

2 1/2"
2 3/4"

2MM.LCK.0F00 . xx + **ONLY LOCK**

2MH.030.UWT8 . xx

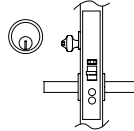

CLASSROOM
ANSI F05

2 1/2"
2 3/4"

2MM.LCK.0G00 . xx + **ONLY LOCK**

2MH.030.UWT8 . xx

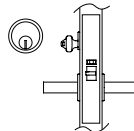

STOREROOM
ANSI F07

2 1/2"
2 3/4"

2MM.LCK.0P00 . xx + **ONLY LOCK**

2MH.030.UWT8 . xx

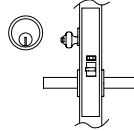

OFFICE/ENTRY
ANSI F04 + F13

2 1/2"
2 3/4"

2MM.LCK.0I00 . xx + **ONLY LOCK**

2MH.030.UWT8 . xx
 Add thumbturns page 127

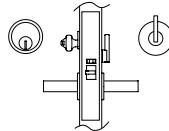

DORMITORY
ANSI F13

2 1/2"
2 3/4"

2MM.LCK.0E00 . xx + **ONLY LOCK**

2MH.030.UWT8 . xx
 Add thumbturns page 127

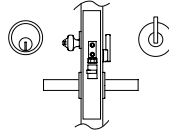

PRIVACY
ANSI F19

2 1/2"
2 3/4"

2MM.LCK.0M00 . xx + **ONLY LOCK**

2MH.030.UWT8 . xx
 Add thumbturns page 127

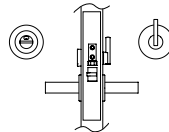

.XX = FINISH CODE

.40 STAINLESS STEEL POWDERCOATED
BLACK RAL 9005 - TO MATCH WITH PBA BLACK ALUMINIUM
.31 WHITE RAL 9010

MATT CLEAR COATED WOOD
WENGÉ
BLEACHED WHITE OAK

(screws, grub screws and plastic parts non powdercoated)
available on request depending on quantities

MORTISE LOCKS: SEE TECHNICAL INFORMATION FOR SOLID DOOR SECTION

MORTISE CYLINDERS NOT INCLUDED see page Levers_141
FOR COMPATIBLE MODELS

STANDARD FACEPLATE AND STRIKEPLATE SATIN STAINLESS STEEL.

SPINDLE DEPTH, LEVERS POSITION ON THE LOCKSET AND FIXING
(SINGLE OR BACK TO BACK) MUST BE SPECIFIED ORDERING - see page Levers_143



ITEM

YOD.030.xxxx.xx

MATERIALS, FINISHING AND DETAILS

.XX = FINISH CODE

	LEATHER	STAINLESS STEEL	
.4H	BLACK PF	SATIN STAINLESS STEEL (ANSI/BHMA 630 - USD32D)	
.3H	BLACK PF	BRIGHT STAINLESS STEEL (ANSI/BHMA 629 - USD32)	
.4P	BROWN PF	SATIN STAINLESS STEEL (ANSI/BHMA 630 - USD32D)	
.3P	BROWN PF	BRIGHT STAINLESS STEEL (ANSI/BHMA 629 - USD32)	

STAINLESS STEEL POWDER-COATED

.40	BLACK RAL 9005 MATT - TO MATCH WITH PBA	
.26	BLACK ALUMINUM	
.31	WHITE RAL 9005 GLOSSY	
.32	GREY	
.38	CHAMPAGNE	
.39	BRONZE - TO MATCH WITH PBA BRONZE ALUMINUM	
.36	ARCHITECTURAL BRONZE	
.56	MEDIUM BRONZE	
.41	SILVER	
.55	GOLD	
.99	COLORS ON REQUEST TO MATCH ANY RAL # (screws, grub screws and plastic parts non powder-coated). Available on request depending on quantities.	

PVD ON SELECTED ITEMS

.83	BLACK SATIN	
	Colors on demand, minimum lot to be agreed. Screws and grub screws not pvd.	

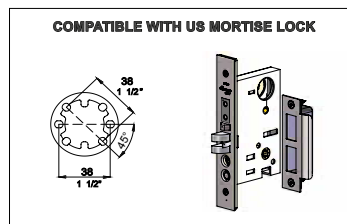

CERTIFICATION LEATHER PF:
THESE PRODUCTS CONTRIBUTE TO **LEED®** CREDITS

THE MANUFACTURER RESERVES THE RIGHT TO ALTER, IMPROVE AND DISCONTINUE ANY FEATURES OF THE PRODUCT (MAKE CHANGES AND IMPROVEMENTS IN DESIGNS AND DIMENSIONS) WITHOUT NOTICE.

ALL DIMENSIONS IN THE CATALOG DRAWINGS ARE APPROXIMATIONS. REQUEST THE APPROPRIATE TECHNICAL DRAWING BEFORE DOOR PREPARATION AND INSTALLATION.

FIXING:

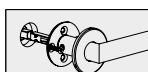

SINGLE SIDE FIXING

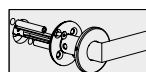

BACK TO BACK FIXING

HANDLE FOR MORTISE
WOOD OR HM DOORS



ITEM THESE PRODUCTS CONTRIBUTE TO **LEED®** CREDITS

YOD.030.0UT8 . xx

mortise

with return spring

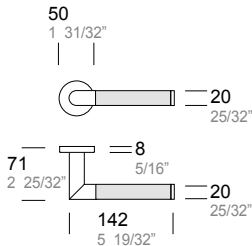

YOD.030.00T4 . xx

mortise

without return spring

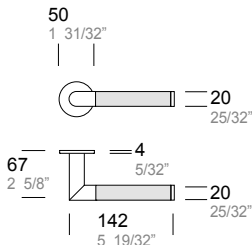

YOD.030.0Uxx . xx

mortise

without return spring

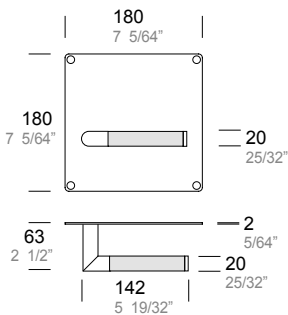

YOD.030.0Uxx . xx

mortise

without return spring

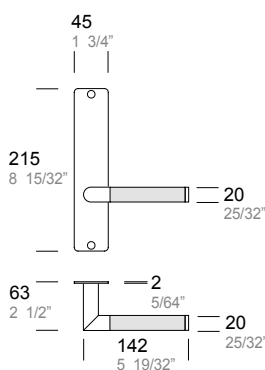

LOCK
WOOD OR HM DOORS

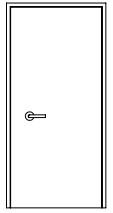

FUNCTION

BACKSET

HOW TO ORDER

PASSAGE
ANSI F01

2 1/2"
2 3/4"

2MM.LCK.0A00 . xx
 ONLY LOCK

+ **YOD.030.0xTx . xx**

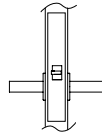

+ **YOD.030.0Uxx . xx**

+ **YOD.030.0Uxx . xx**

OFFICE/CORRIDOR
ANSI F04

2 1/2"
2 3/4"

2MM.LCK.0F00 . xx
 ONLY LOCK

+ **YOD.030.0xTx . xx**

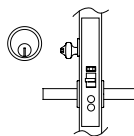

+ **YOD.030.0Uxx . xx**

+ **YOD.030.0Uxx . xx**

CLASSROOM
ANSI F05

2 1/2"
2 3/4"

2MM.LCK.0G00 . xx
 ONLY LOCK

+ **YOD.030.0xTx . xx**

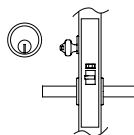

+ **YOD.030.0Uxx . xx**

+ **YOD.030.0Uxx . xx**

STOREROOM
ANSI F07

2 1/2"
2 3/4"

2MM.LCK.0P00 . xx
 ONLY LOCK

+ **YOD.030.0xTx . xx**

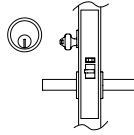

+ **YOD.030.0Uxx . xx**

+ **YOD.030.0Uxx . xx**

OFFICE/ENTRY
ANSI F04 + F13

2 1/2"
2 3/4"

2MM.LCK.0I00 . xx
 ONLY LOCK

+ **YOD.030.0xTx . xx**

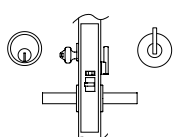

+ **YOD.030.0Uxx . xx**
 Add thumbs turns
page Levers_127

+ **YOD.030.0Uxx . xx**
 Add thumbs turns
page Levers_127

+ **YOD.030.0Uxx . xx**
 Add thumbs turns
page Levers_127

DORMITORY
ANSI F13

2 1/2"
2 3/4"

2MM.LCK.0E00 . xx
 ONLY LOCK

+ **YOD.030.0xTx . xx**

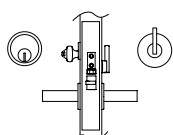

+ **YOD.030.0Uxx . xx**
 Add thumbs turns
page Levers_127

+ **YOD.030.0Uxx . xx**
 Add thumbs turns
page Levers_127

+ **YOD.030.0Uxx . xx**
 Add thumbs turns
page Levers_127

PRIVACY
ANSI F19

2 1/2"
2 3/4"

2MM.LCK.0M00 . xx
 ONLY LOCK

+ **YOD.030.0xTx . xx**

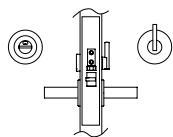

+ **YOD.030.0Uxx . xx**
 Add thumbs turns
page Levers_127

+ **YOD.030.0Uxx . xx**
 Add thumbs turns
page Levers_127

+ **YOD.030.0Uxx . xx**
 Add thumbs turns
page Levers_127

.XX = FINISH CODE

LEATHER	STAINLESS STEEL
.4H BLACK PF	SATIN STAINLESS STEEL (ANSI/BHMA 630 - USD32D)
.3H BLACK PF	BRIGHT STAINLESS STEEL (ANSI/BHMA 629 - USD32)
.4P BROWN PF	SATIN STAINLESS STEEL (ANSI/BHMA 630 - USD32D)
.3P BROWN PF	BRIGHT STAINLESS STEEL (ANSI/BHMA 629 - USD32)

PVD ON REQUEST

.83 BLACK SATIN
Colors on demand, minimum lot to be agreed.
Screws and grub screws not pvd

STAINLESS STEEL POWDER-COATED ON REQUEST

.40 BLACK RAL 9005 MATT - TO MATCH WITH PBA BLACK ALUMINUM
.26 BLACK RAL 9005 GLOSSY
.31 WHITE RAL 9010
.32 GREY
.38 CHAMPAGNE
.39 BRONZE - TO MATCH WITH PBA BRONZE ALUMINUM
.36 ARCHITECTURAL BRONZE
.56 MEDIUM BRONZE
.41 SILVER
.55 GOLD

.99 COLORS ON REQUEST TO MATCH ANY RAL #
(screws, grub screws and plastic parts non powder-coated)
available on request depending on quantities

MORTISE LOCKS: SEE TECHNICAL INFORMATION FOR SOLID DOOR SECTION
MORTISE CYLINDERS NOT INCLUDED see page Levers_141
FOR COMPATIBLE MODELS

STANDARD FACEPLATE AND STRIKEPLATE SATIN STAINLESS STEEL.

SPINDLE DEPTH, LEVERS POSITION ON THE LOCKSET AND FIXING
(SINGLE OR BACK TO BACK) MUST BE SPECIFIED ORDERING
see page Levers_143

HANDLE FOR MORTISE

GLASS DOORS WITH ALUMINUM PROFILE
OR WOOD AND HM DOORS

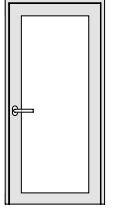

ITEM THESE PRODUCTS CONTRIBUTE TO **LEED®** CREDITS

YOD.030.0008 . xx

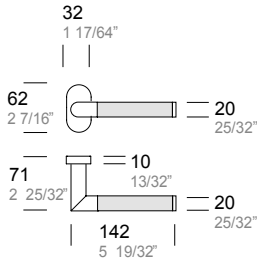

Ø with return spring

YOD.030.0004 . xx

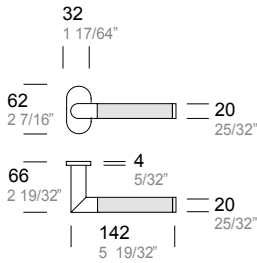

Ø without return spring

.XX = FINISH CODE

LEATHER		STAINLESS STEEL	
.4H	BLACK PF	SATIN STAINLESS STEEL (ANSI/BHMA 630 - USD32D)	
.3H	BLACK PF	BRIGHT STAINLESS STEEL (ANSI/BHMA 629 - USD32)	
.4P	BROWN PF	SATIN STAINLESS STEEL (ANSI/BHMA 630 - USD32D)	
.3P	BROWN PF	BRIGHT STAINLESS STEEL (ANSI/BHMA 629 - USD32)	

PVD ON REQUEST

.83 BLACK SATIN
Colors on demand, minimum lot to be agreed.
Screws and grub screws not pvd

STAINLESS STEEL POWDER-COATED ON REQUEST

.40	BLACK RAL 9005 MATT - TO MATCH WITH PBA BLACK ALUMINUM
.26	BLACK RAL 9005 GLOSSY
.31	WHITE RAL 9010
.32	GREY
.38	CHAMPAGNE
.39	BRONZE - TO MATCH WITH PBA BRONZE ALUMINUM
.36	ARCHITECTURAL BRONZE
.56	MEDIUM BRONZE
.41	SILVER
.55	GOLD

.99 COLORS ON REQUEST TO MATCH ANY RAL #
(screws, grub screws and plastic parts non powder-coated)
available on request depending on quantities

SPINDLE DEPTH, LEVERS POSITION ON THE LOCKSET AND FIXING
(SINGLE OR BACK TO BACK) MUST BE SPECIFIED ORDERING
see page Levers_143



ITEM

2MH.030.ULT8.xx

MATERIALS, FINISHING AND DETAILS

.XX = FINISH CODE

- | | |
|------------|---|
| | STAINLESS STEEL POWDER COATED |
| .40 | BLACK RAL 9005 - TO MATCH WITH PBA BLACK ALUMINIUM |
| .31 | WHITE RAL 9010 |



LEATHER

- BLACK**
WHITE

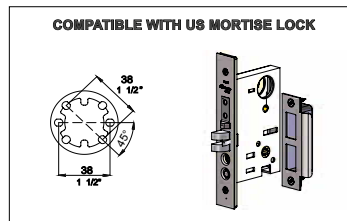

Screws, grub screws and plastic parts non powder-coated.
Available on request depending on quantities.



CERTIFICATION LEATHER PF:  

THESE PRODUCTS CONTRIBUTE TO **LEED®** CREDITS

THE MANUFACTURER RESERVES THE RIGHT TO ALTER, IMPROVE AND DISCONTINUE ANY FEATURES OF THE PRODUCT (MAKE CHANGES AND IMPROVEMENTS IN DESIGNS AND DIMENSIONS) WITHOUT NOTICE.

ALL DIMENSIONS IN THE CATALOG DRAWINGS ARE APPROXIMATIONS. REQUEST THE APPROPRIATE TECHNICAL DRAWING BEFORE DOOR PREPARATION AND INSTALLATION.

FIXING:

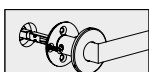

SINGLE SIDE FIXING

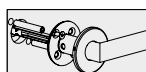

BACK TO BACK FIXING

HANDLE FOR MORTISE
WOOD OR HM DOORS



ITEM THESE PRODUCTS CONTRIBUTE TO LEED® CREDITS

2MH.030.ULT8 . xx



mortise

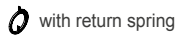

with return spring

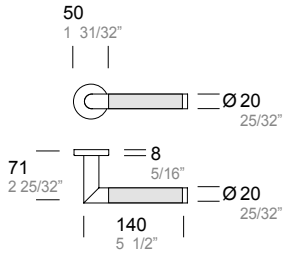

- Matte powder coated
- Leather



.31



.40

LOCK
WOOD OR HM DOORS

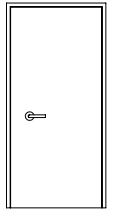

FUNCTION BACKSET HOW TO ORDER

PASSAGE ANSI F01 2 1/2" 2 3/4" **2MM.LCK.0A00 . xx** + **2MH.030.ULT8 . xx**
ONLY LOCK

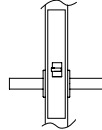

OFFICE/CORRIDOR ANSI F04 2 1/2" 2 3/4" **2MM.LCK.0F00 . xx** + **2MH.030.ULT8 . xx**
ONLY LOCK

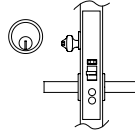

CLASSROOM ANSI F05 2 1/2" 2 3/4" **2MM.LCK.0G00 . xx** + **2MH.030.ULT8 . xx**
ONLY LOCK

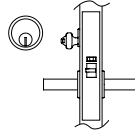

STOREROOM ANSI F07 2 1/2" 2 3/4" **2MM.LCK.0P00 . xx** + **2MH.030.ULT8 . xx**
ONLY LOCK

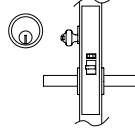

OFFICE/ENTRY ANSI F04 + F13 2 1/2" 2 3/4" **2MM.LCK.0I00 . xx** + **2MH.030.ULT8 . xx**
ONLY LOCK Add thumbturns page Levers_127

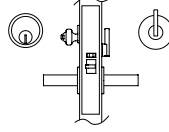

DORMITORY ANSI F13 2 1/2" 2 3/4" **2MM.LCK.0E00 . xx** + **2MH.030.ULT8 . xx**
ONLY LOCK Add thumbturns page Levers_127

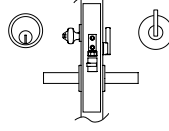

PRIVACY ANSI F19 2 1/2" 2 3/4" **2MM.LCK.0M00 . xx** + **2MH.030.ULT8 . xx**
ONLY LOCK Add thumbturns page Levers_127

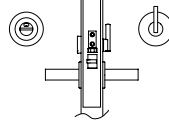

.XX = FINISH CODE

- | | |
|--|-------------------------|
| .40 STAINLESS STEEL POWDER-COATED
BLACK RAL 9005 - TO MATCH WITH PBA BLACK ALUMINIUM | LEATHER
BLACK |
| .31 WHITE RAL 9010 | WHITE |

(screws, grub screws and plastic parts non powder-coated) available on request depending on quantities

MORTISE LOCKS: SEE TECHNICAL INFORMATION FOR SOLID DOOR SECTION
MORTISE CYLINDERS NOT INCLUDED see page Levers_141 FOR COMPATIBLE MODELS

STANDARD FACEPLATE AND STRIKEPLATE SATIN STAINLESS STEEL.

SPINDLE DEPTH, LEVERS POSITION ON THE LOCKSET AND FIXING (SINGLE OR BACK TO BACK) MUST BE SPECIFIED ORDERING - see page Levers_143

ANTIMICROBIAL
COPPER

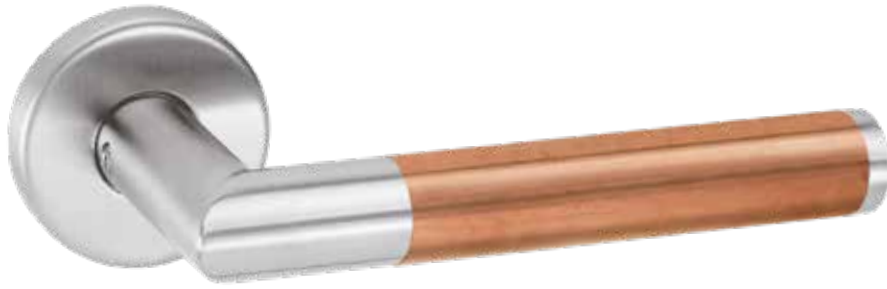

ITEM

2MU.030.xxxx.4R

MATERIALS, FINISHING AND DETAILS

FINISH CODE

	COPPER	STAINLESS STEEL	
.4R	SATIN COPPER	SATIN STAINLESS STEEL (ANSI/BHMA 630 - USD32D)	

AVAILABLE WITH RETURN SPRING

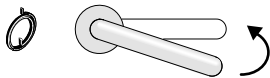

COMPATIBLE WITH US MORTISE LOCK

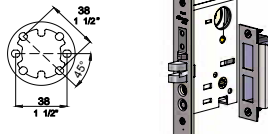

THESE PRODUCTS CONTRIBUTE TO **LEED®** CREDITS

THE MANUFACTURER RESERVES THE RIGHT TO ALTER, IMPROVE AND DISCONTINUE ANY FEATURES OF THE PRODUCT (MAKE CHANGES AND IMPROVEMENTS IN DESIGNS AND DIMENSIONS) WITHOUT NOTICE.

ALL DIMENSIONS IN THE CATALOG DRAWINGS ARE APPROXIMATIONS. REQUEST THE APPROPRIATE TECHNICAL DRAWING BEFORE DOOR PREPARATION AND INSTALLATION.

FIXING:

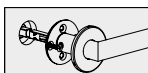

SINGLE SIDE FIXING

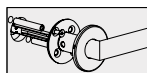

BACK TO BACK FIXING

HANDLE FOR MORTISE
WOOD OR HM DOORS

ANTIMICROBIAL
COPPER



ITEM THESE PRODUCTS CONTRIBUTE TO **LEED®** CREDITS

2MU.030.0UT8 .4R



mortise

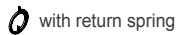

with return spring

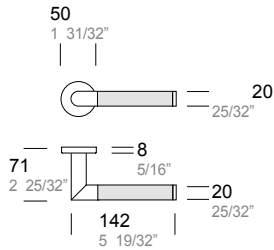

2MU.030.00T4 .4R



mortise

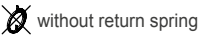

without return spring

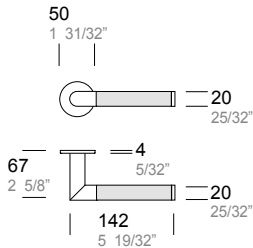

- Stainless Steel
- Satin Copper

LOCK
WOOD OR HM DOORS



FUNCTION	BACKSET	HOW TO ORDER
PASSAGE ANSI F01	2 1/2" 2 3/4"	2MM.LCK.0A00 . xx + 2MU.030.0xTx .4R ONLY LOCK
OFFICE/CORRIDOR ANSI F04	2 1/2" 2 3/4"	2MM.LCK.0F00 . xx + 2MU.030.0xTx .4R ONLY LOCK
CLASSROOM ANSI F05	2 1/2" 2 3/4"	2MM.LCK.0G00 . xx + 2MU.030.0xTx .4R ONLY LOCK
STOREROOM ANSI F07	2 1/2" 2 3/4"	2MM.LCK.0P00 . xx + 2MU.030.0xTx .4R ONLY LOCK
OFFICE/ENTRY ANSI F04 + F13	2 1/2" 2 3/4"	2MM.LCK.0I00 . xx + 2MU.030.0xTx .4R ONLY LOCK Add thumbturns page Levers_127
DORMITORY ANSI F13	2 1/2" 2 3/4"	2MM.LCK.0E00 . xx + 2MU.030.0xTx .4R ONLY LOCK Add thumbturns page Levers_127
PRIVACY ANSI F19	2 1/2" 2 3/4"	2MM.LCK.0M00 . xx + YOD.030.0xTx .4R ONLY LOCK Add thumbturns page Levers_127

FINISH CODE

- COPPER**
- STAINLESS STEEL**
- .4R SATIN COPPER
- SATIN STAINLESS STEEL (ANSI/BHMA 630 - USD32D)

MORTISE LOCKS: SEE TECHNICAL INFORMATION FOR SOLID DOOR SECTION
MORTISE CYLINDERS NOT INCLUDED see page Levers_141
FOR COMPATIBLE MODELS
STANDARD FACEPLATE AND STRIKEPLATE SATIN STAINLESS STEEL.
SPINDLE DEPTH, LEVERS POSITION ON THE LOCKSET AND FIXING
(SINGLE OR BACK TO BACK) MUST BE SPECIFIED ORDERING - see page Levers_143



ITEM

2AM.030.xxTx.xx

MATERIALS, FINISHING AND DETAILS

.XX = FINISH CODE

SATIN ANODIZED ALUMINUM

.67 BRONZE

.68 BLACK

.69 SILVER



DIFFERENCES IN THE FINISHING OF (DIFFERENT) COMPONENTS ARE DUE TO THE DIFFERENT PRODUCTION METHODS. THESE VARIATIONS ARE NOT CONSIDERED DEFECTS AND ARE A NATURAL RESULT OF THE FINISHING PROCESS.

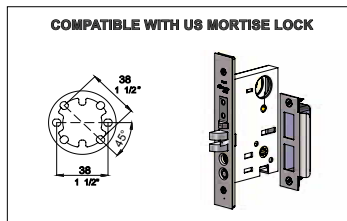
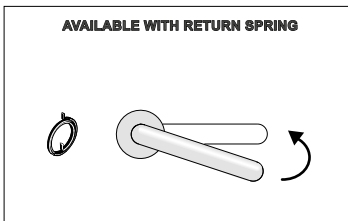

THESE PRODUCTS CONTRIBUTE TO **LEED**® CREDITS

THE MANUFACTURER RESERVES THE RIGHT TO ALTER, IMPROVE AND DISCONTINUE ANY FEATURES OF THE PRODUCT (MAKE CHANGES AND IMPROVEMENTS IN DESIGNS AND DIMENSIONS) WITHOUT NOTICE.

ALL DIMENSIONS IN THE CATALOG DRAWINGS ARE APPROXIMATIONS. REQUEST THE APPROPRIATE TECHNICAL DRAWING BEFORE DOOR PREPARATION AND INSTALLATION.

FIXING:

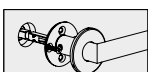

SINGLE SIDE FIXING

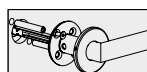

BACK TO BACK FIXING

HANDLE FOR MORTISE
WOOD OR HM DOORS



ITEM THESE PRODUCTS CONTRIBUTE TO LEED® CREDITS **Declare.**

2AM.030.0UT8 . xx

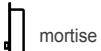
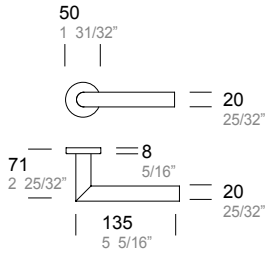

with return spring

2AM.030.00T4 . xx

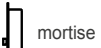
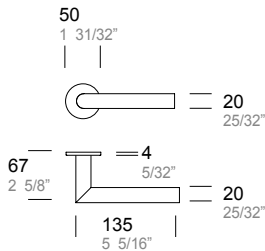

without return spring

LOCK
WOOD OR HM DOORS

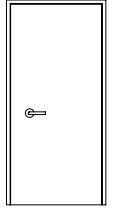
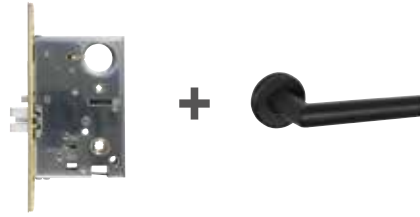

FUNCTION	BACKSET	HOW TO ORDER
PASSAGE ANSI F01 	2 1/2" 2 3/4"	2MM.LCK.0A00 . xx + 2AM.030.0xTx . xx ONLY LOCK
OFFICE/CORRIDOR ANSI F04 	2 1/2" 2 3/4"	2MM.LCK.0F00 . xx + 2AM.030.0xTx . xx ONLY LOCK
CLASSROOM ANSI F05 	2 1/2" 2 3/4"	2MM.LCK.0G00 . xx + 2AM.030.0xTx . xx ONLY LOCK
STOREROOM ANSI F07 	2 1/2" 2 3/4"	2MM.LCK.0P00 . xx + 2AM.030.0xTx . xx ONLY LOCK
OFFICE/ENTRY ANSI F04 + F13 	2 1/2" 2 3/4"	2MM.LCK.0I00 . xx + 2AM.030.0xTx . xx ONLY LOCK Add thumbturns page Levers_127
DORMITORY ANSI F13 	2 1/2" 2 3/4"	2MM.LCK.0E00 . xx + 2AM.030.0xTx . xx ONLY LOCK Add thumbturns page Levers_127
PRIVACY ANSI F19 	2 1/2" 2 3/4"	2MM.LCK.0M00 . xx + 2AM.030.0xTx . xx ONLY LOCK Add thumbturns page Levers_127

.XX = FINISH CODE

- .67 SATIN ANODIZED ALUMINUM
- .68 BRONZE
- .69 BLACK
- .69 SILVER

DIFFERENCES IN THE FINISHING OF (DIFFERENT) COMPONENTS ARE DUE TO THE DIFFERENT PRODUCTION METHODS. THESE VARIATIONS ARE NOT CONSIDERED DEFECTS AND ARE A NATURAL RESULT OF THE FINISHING PROCESS.

MORTISE LOCKS: SEE TECHNICAL INFORMATION FOR SOLID DOOR SECTION
MORTISE CYLINDERS NOT INCLUDED see page Levers_141 FOR COMPATIBLE MODELS

STANDARD FACEPLATE AND STRIKEPLATE SATIN STAINLESS STEEL.

SPINDLE DEPTH, LEVERS POSITION ON THE LOCKSET AND FIXING (SINGLE OR BACK TO BACK) MUST BE SPECIFIED ORDERING - see page Levers_143



ITEM
2AM.030.ULT8.68

MATERIALS, FINISHING AND DETAILS

.XX = FINISH CODE

	SATIN ANODIZED ALUMINUM	LEATHER	
.68	BLACK	BLACK	

DIFFERENCES IN THE FINISHING OF (DIFFERENT) COMPONENTS ARE DUE TO THE DIFFERENT PRODUCTION METHODS. THESE VARIATIONS ARE NOT CONSIDERED DEFECTS AND ARE A NATURAL RESULT OF THE FINISHING PROCESS.

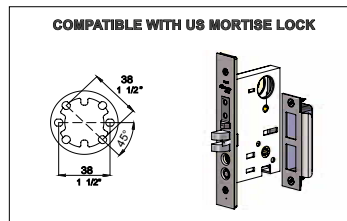

CERTIFICATION LEATHER PF:
THESE PRODUCTS CONTRIBUTE TO **LEED®** CREDITS

THE MANUFACTURER RESERVES THE RIGHT TO ALTER, IMPROVE AND DISCONTINUE ANY FEATURES OF THE PRODUCT (MAKE CHANGES AND IMPROVEMENTS IN DESIGNS AND DIMENSIONS) WITHOUT NOTICE.

ALL DIMENSIONS IN THE CATALOG DRAWINGS ARE APPROXIMATIONS. REQUEST THE APPROPRIATE TECHNICAL DRAWING BEFORE DOOR PREPARATION AND INSTALLATION.

FIXING:

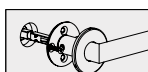

SINGLE SIDE FIXING

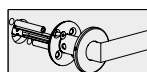

BACK TO BACK FIXING

HANDLE FOR MORTISE
WOOD OR HM DOORS



ITEM THESE PRODUCTS CONTRIBUTE TO LEED® CREDITS

2AM.030.ULT8 .68

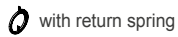
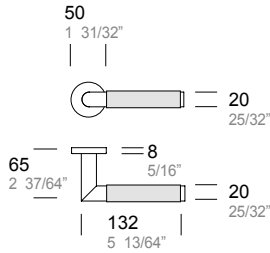

- Aluminium
- Leather

LOCK
WOOD OR HM DOORS

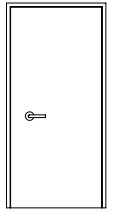

FUNCTION BACKSET HOW TO ORDER

<p>PASSAGE ANSI F01</p>	<p>2 1/2" 2 3/4"</p>	<p>2MM.LCK.0A00 . xx + ONLY LOCK</p>	<p>2AM.030.ULT8 .68</p>
<p>OFFICE/CORRIDOR ANSI F04</p>	<p>2 1/2" 2 3/4"</p>	<p>2MM.LCK.0F00 . xx + ONLY LOCK</p>	<p>2AM.030.ULT8 .68</p>
<p>CLASSROOM ANSI F05</p>	<p>2 1/2" 2 3/4"</p>	<p>2MM.LCK.0G00 . xx + ONLY LOCK</p>	<p>2AM.030.ULT8 .68</p>
<p>STOREROOM ANSI F07</p>	<p>2 1/2" 2 3/4"</p>	<p>2MM.LCK.0P00 . xx + ONLY LOCK</p>	<p>2AM.030.ULT8 .68</p>
<p>OFFICE/ENTRY ANSI F04 + F13</p>	<p>2 1/2" 2 3/4"</p>	<p>2MM.LCK.0I00 . xx + ONLY LOCK</p>	<p>2AM.030.ULT8 .68 Add thumbturns page Levers_127</p>
<p>DORMITORY ANSI F13</p>	<p>2 1/2" 2 3/4"</p>	<p>2MM.LCK.0E00 . xx + ONLY LOCK</p>	<p>2AM.030.ULT8 .68 Add thumbturns page Levers_127</p>
<p>PRIVACY ANSI F19</p>	<p>2 1/2" 2 3/4"</p>	<p>2MM.LCK.0M00 . xx + ONLY LOCK</p>	<p>2AM.030.ULT8 .68 Add thumbturns page Levers_127</p>

.XX = FINISH CODE

**.68 SATIN ANODIZED ALUMINUM
BLACK**

**LEATHER
BLACK**

DIFFERENCES IN THE FINISHING OF (DIFFERENT) COMPONENTS ARE DUE TO THE DIFFERENT PRODUCTION METHODS. THESE VARIATIONS ARE NOT CONSIDERED DEFECTS AND ARE A NATURAL RESULT OF THE FINISHING PROCESS.

MORTISE LOCKS: SEE TECHNICAL INFORMATION FOR SOLID DOOR SECTION
MORTISE CYLINDERS NOT INCLUDED see page Levers_141
FOR COMPATIBLE MODELS

STANDARD FACEPLATE AND STRIKEPLATE SATIN STAINLESS STEEL.

SPINDLE DEPTH, LEVERS POSITION ON THE LOCKSET AND FIXING
(SINGLE OR BACK TO BACK) MUST BE SPECIFIED ORDERING - see page Levers_143



ITEM

2AM.001.xxTx.xx

MATERIALS, FINISHING AND DETAILS

.XX = FINISH CODE

SATIN ANODIZED ALUMINUM

.67 BRONZE

.68 BLACK

.69 SILVER

.66 CHAMPAGNE



DIFFERENCES IN THE FINISHING OF (DIFFERENT) COMPONENTS ARE DUE TO THE DIFFERENT PRODUCTION METHODS. THESE VARIATIONS ARE NOT CONSIDERED DEFECTS AND ARE A NATURAL RESULT OF THE FINISHING PROCESS.

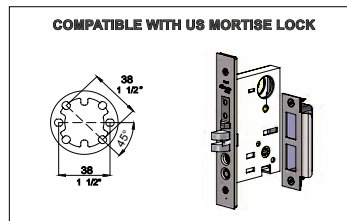
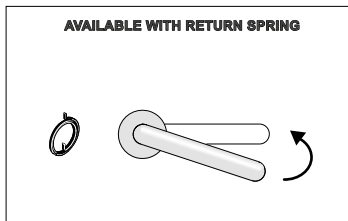

THESE PRODUCTS CONTRIBUTE TO **LEED®** CREDITS

THE MANUFACTURER RESERVES THE RIGHT TO ALTER, IMPROVE AND DISCONTINUE ANY FEATURES OF THE PRODUCT (MAKE CHANGES AND IMPROVEMENTS IN DESIGNS AND DIMENSIONS) WITHOUT NOTICE.

ALL DIMENSIONS IN THE CATALOG DRAWINGS ARE APPROXIMATIONS. REQUEST THE APPROPRIATE TECHNICAL DRAWING BEFORE DOOR PREPARATION AND INSTALLATION.

FIXING:

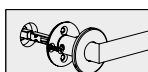

SINGLE SIDE FIXING

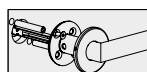

BACK TO BACK FIXING

HANDLE FOR MORTISE
WOOD OR HM DOORS



ITEM THESE PRODUCTS CONTRIBUTE TO **LEED® CREDITS** **Declare.**

2AM.001.0UT8 . xx

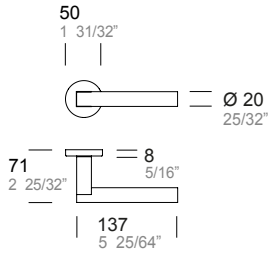

mortise

with return spring

2AM.001.00T4 . xx

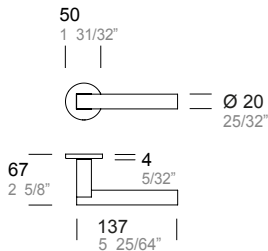

mortise

without return spring

LOCK
WOOD OR HM DOORS



FUNCTION **BACKSET** **HOW TO ORDER**

PASSAGE ANSI F01 2 1/2" **2MM.LCK.0A00 . xx** + **2AM.001.0xTx . xx**
2 3/4" ONLY LOCK

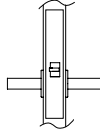

OFFICE/CORRIDOR ANSI F04 2 1/2" **2MM.LCK.0F00 . xx** + **2AM.001.0xTx . xx**
2 3/4" ONLY LOCK

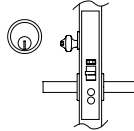

CLASSROOM ANSI F05 2 1/2" **2MM.LCK.0G00 . xx** + **2AM.001.0xTx . xx**
2 3/4" ONLY LOCK

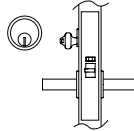

STOREROOM ANSI F07 2 1/2" **2MM.LCK.0P00 . xx** + **2AM.001.0xTx . xx**
2 3/4" ONLY LOCK

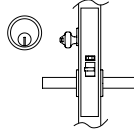

OFFICE/ENTRY ANSI F04 + F13 2 1/2" **2MM.LCK.0I00 . xx** + **2AM.001.0xTx . xx**
2 3/4" ONLY LOCK Add thumbturns page Levers_127

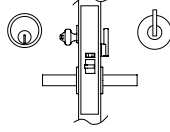

DORMITORY ANSI F13 2 1/2" **2MM.LCK.0E00 . xx** + **2AM.001.0xTx . xx**
2 3/4" ONLY LOCK Add thumbturns page Levers_127

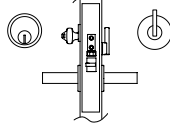

PRIVACY ANSI F19 2 1/2" **2MM.LCK.0M00 . xx** + **2AM.001.0xTx . xx**
2 3/4" ONLY LOCK Add thumbturns page Levers_127

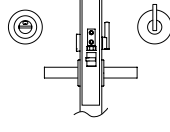

.XX = FINISH CODE

- SATIN ANODIZED ALUMINUM**
- .67 BRONZE
- .68 BLACK
- .69 SILVER
- .66 CHAMPAGNE

DIFFERENCES IN THE FINISHING OF (DIFFERENT) COMPONENTS ARE DUE TO THE DIFFERENT PRODUCTION METHODS. THESE VARIATIONS ARE NOT CONSIDERED DEFECTS AND ARE A NATURAL RESULT OF THE FINISHING PROCESS.

MORTISE LOCKS: SEE TECHNICAL INFORMATION FOR SOLID DOOR SECTION

MORTISE CYLINDERS NOT INCLUDED see page Levers_141 FOR COMPATIBLE MODELS

STANDARD FACEPLATE AND STRIKEPLATE SATIN STAINLESS STEEL.

SPINDLE DEPTH, LEVERS POSITION ON THE LOCKSET AND FIXING (SINGLE OR BACK TO BACK) MUST BE SPECIFIED ORDERING - see page Levers_143



TITLE 24 *
COMPLIANCE
AVAILABLE

See pag. Levers_144

ITEM

2MM.30B.xxTx.xx

MATERIALS, FINISHING AND DETAILS

.XX = FINISH CODE

STAINLESS STEEL

- .44 SATIN STAINLESS STEEL (ANSI/BHMA 630 - USD32D)
- .43 BRIGHT STAINLESS STEEL (ANSI/BHMA 629 - USD32)



STAINLESS STEEL POWDER-COATED

- .40 BLACK RAL 9005 MATT - TO MATCH WITH PBA
- .26 BLACK ALUMINUM
- .31 WHITE RAL 9005 GLOSSY
- .32 GREY
- .38 CHAMPAGNE
- .39 BRONZE - TO MATCH WITH PBA BRONZE ALUMINUM
- .36 ARCHITECTURAL BRONZE
- .56 MEDIUM BRONZE
- .41 SILVER
- .55 GOLD
- .99 COLORS ON REQUEST TO MATCH ANY RAL #
(screws, grub screws and plastic parts non powder-coated).
Available on request depending on quantities.



PVD ON SELECTED ITEMS

- .83 BLACK SATIN
Colors on demand, minimum lot to be agreed.
Screws and grub screws not pvd.

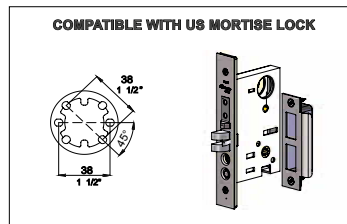

THESE PRODUCTS CONTRIBUTE TO LEED® CREDITS

THE MANUFACTURER RESERVES THE RIGHT TO ALTER, IMPROVE AND DISCONTINUE ANY FEATURES OF THE PRODUCT (MAKE CHANGES AND IMPROVEMENTS IN DESIGNS AND DIMENSIONS) WITHOUT NOTICE.

ALL DIMENSIONS IN THE CATALOG DRAWINGS ARE APPROXIMATIONS. REQUEST THE APPROPRIATE TECHNICAL DRAWING BEFORE DOOR PREPARATION AND INSTALLATION.

FIXING:

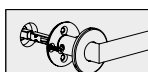

SINGLE SIDE FIXING

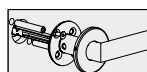

BACK TO BACK FIXING

HANDLE FOR MORTISE
WOOD OR HM DOORS



TITLE 24 *
COMPLIANCE
AVAILABLE



ITEM THESE PRODUCTS CONTRIBUTE TO LEED® CREDITS

2MM.30B.0UT8 . xx

- mortise
- with return spring

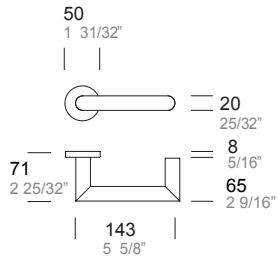

LOCK
WOOD OR HM DOORS



TITLE 24 *
COMPLIANCE
AVAILABLE

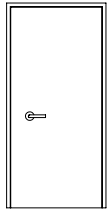

FUNCTION BACKSET HOW TO ORDER

PASSAGE ANSI F01 	2 1/2" 2 3/4"	2MM.LCK.0A00 . xx + ONLY LOCK	2MM.30B.0xTx . xx
OFFICE/CORRIDOR ANSI F04 	2 1/2" 2 3/4"	2MM.LCK.0F00 . xx + ONLY LOCK	2MM.30B.0xTx . xx
CLASSROOM ANSI F05 	2 1/2" 2 3/4"	2MM.LCK.0G00 . xx + ONLY LOCK	2MM.30B.0xTx . xx
STOREROOM ANSI F07 	2 1/2" 2 3/4"	2MM.LCK.0P00 . xx + ONLY LOCK	2MM.30B.0xTx . xx
OFFICE/ENTRY ANSI F04 + F13 	2 1/2" 2 3/4"	2MM.LCK.0I00 . xx + ONLY LOCK	2MM.30B.0xTx . xx Add thumbturns page Levers_127
DORMITORY ANSI F13 	2 1/2" 2 3/4"	2MM.LCK.0E00 . xx + ONLY LOCK	2MM.30B.0xTx . xx Add thumbturns page Levers_127
PRIVACY ANSI F19 	2 1/2" 2 3/4"	2MM.LCK.0M00 . xx + ONLY LOCK	2MM.30B.0xTx . xx Add thumbturns page Levers_127

.XX = FINISH CODE

STAINLESS STEEL .43 BRIGHT STAINLESS STEEL (ANSI/BHMA 629 - USD32) .44 SATIN STAINLESS STEEL (ANSI/BHMA 630 - USD32D)	STAINLESS STEEL POWDER-COATED ON REQUEST .40 BLACK RAL 9005 MATT - TO MATCH WITH PBA BLACK ALUMINUM .26 BLACK RAL 9005 GLOSSY .31 WHITE RAL 9010 .32 GREY .38 CHAMPAGNE .39 BRONZE - TO MATCH WITH PBA BRONZE ALUMINUM .36 ARCHITECTURAL BRONZE .56 MEDIUM BRONZE .41 SILVER .55 GOLD
PVD ON REQUEST .83 BLACK SATIN Colors on demand, minimum lot to be agreed. Screws and grub screws not pvd	
.99 COLORS ON REQUEST TO MATCH ANY RAL # (screws, grub screws and plastic parts non powder-coated) available on request depending on quantities	

MORTISE LOCKS: SEE TECHNICAL INFORMATION FOR SOLID DOOR SECTION
MORTISE CYLINDERS NOT INCLUDED see page Levers_141
FOR COMPATIBLE MODELS

STANDARD FACEPLATE AND STRIKEPLATE SATIN STAINLESS STEEL.

SPINDLE DEPTH, LEVERS POSITION ON THE LOCKSET AND FIXING
(SINGLE OR BACK TO BACK) MUST BE SPECIFIED ORDERING - see page Levers_143

* SEE TECHNICAL INFORMATION FOR TITLE 24 INFORMATION
pag. Levers_144





ITEM

2MM.028.xxxx.xx











MATERIALS, FINISHING AND DETAILS

.XX = FINISH CODE

STAINLESS STEEL

- .44 SATIN STAINLESS STEEL (ANSI/BHMA 630 - USD32D)** 
- .43 BRIGHT STAINLESS STEEL (ANSI/BHMA 629 - USD32)** 

STAINLESS STEEL POWDER-COATED

- .40 BLACK RAL 9005 MATT - TO MATCH WITH PBA** 
- .26 BLACK ALUMINUM** 
- .31 WHITE RAL 9005 GLOSSY** 
- .32 GREY** 
- .38 CHAMPAGNE** 
- .39 BRONZE - TO MATCH WITH PBA BRONZE ALUMINUM** 
- .36 ARCHITECTURAL BRONZE** 
- .56 MEDIUM BRONZE** 
- .41 SILVER** 
- .55 GOLD** 
- .99 COLORS ON REQUEST TO MATCH ANY RAL #**
(screws, grub screws and plastic parts non powder-coated).
Available on request depending on quantities.

PVD ON SELECTED ITEMS

- .83 BLACK SATIN** 
Colors on demand, minimum lot to be agreed.
Screws and grub screws not pvd.

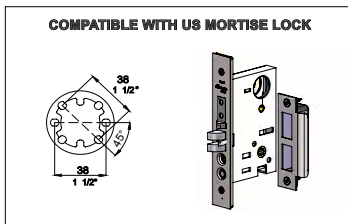
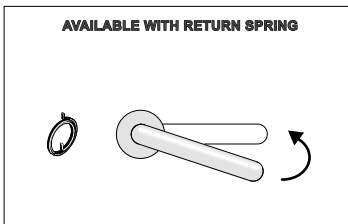

THESE PRODUCTS CONTRIBUTE TO **LEED®** CREDITS

THE MANUFACTURER RESERVES THE RIGHT TO ALTER, IMPROVE AND DISCONTINUE ANY FEATURES OF THE PRODUCT (MAKE CHANGES AND IMPROVEMENTS IN DESIGNS AND DIMENSIONS) WITHOUT NOTICE.

ALL DIMENSIONS IN THE CATALOG DRAWINGS ARE APPROXIMATIONS. REQUEST THE APPROPRIATE TECHNICAL DRAWING BEFORE DOOR PREPARATION AND INSTALLATION.

FIXING:

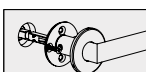

SINGLE SIDE FIXING

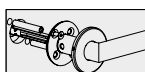

BACK TO BACK FIXING

HANDLE FOR MORTISE
WOOD OR HM DOORS



Ø 20



ITEM THESE PRODUCTS CONTRIBUTE TO LEED® CREDITS **Declare.**

2MM.028.0UT8 . xx

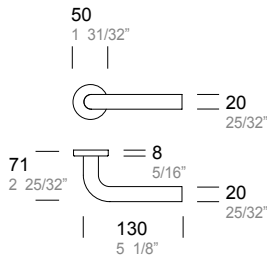

mortise

with return spring

2MM.028.00T4 . xx

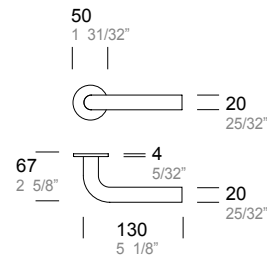

mortise

without return spring

2MM.028.0Uxx . xx

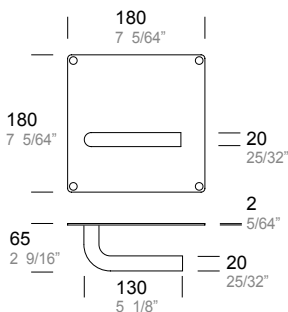

mortise

without return spring

2MM.028.0Uxx . xx

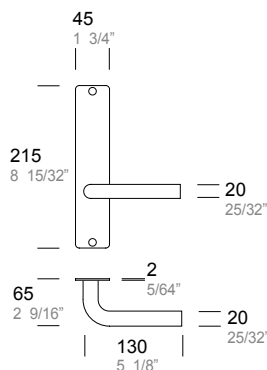

mortise

without return spring

LOCK
WOOD OR HM DOORS



+



Ø 20

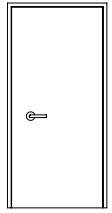

FUNCTION	BACKSET	HOW TO ORDER
PASSAGE ANSI F01	2 1/2" 2 3/4"	2MM.LCK.0A00 . xx + 2MM.028.0xTx . xx ONLY LOCK + 2MM.028.0Uxx . xx + 2MM.028.0Uxx . xx
OFFICE/CORRIDOR ANSI F04	2 1/2" 2 3/4"	2MM.LCK.0F00 . xx + 2MM.028.0xTx . xx ONLY LOCK + 2MM.028.0Uxx . xx + 2MM.028.0Uxx . xx
CLASSROOM ANSI F05	2 1/2" 2 3/4"	2MM.LCK.0G00 . xx + 2MM.028.0xTx . xx ONLY LOCK + 2MM.028.0Uxx . xx + 2MM.028.0Uxx . xx
STOREROOM ANSI F07	2 1/2" 2 3/4"	2MM.LCK.0P00 . xx + 2MM.028.0xTx . xx ONLY LOCK + 2MM.028.0Uxx . xx + 2MM.028.0Uxx . xx
OFFICE/ENTRY ANSI F04 + F13	2 1/2" 2 3/4"	2MM.LCK.0I00 . xx + 2MM.028.0xTx . xx ONLY LOCK + 2MM.028.0Uxx . xx Add thumbturns page Levers_127 + 2MM.028.0Uxx . xx Add thumbturns page Levers_127 + 2MM.028.0Uxx . xx Add thumbturns page Levers_127
DORMITORY ANSI F13	2 1/2" 2 3/4"	2MM.LCK.0E00 . xx + 2MM.028.0xTx . xx ONLY LOCK + 2MM.028.0Uxx . xx Add thumbturns page Levers_127 + 2MM.028.0Uxx . xx Add thumbturns page Levers_127 + 2MM.028.0Uxx . xx Add thumbturns page Levers_127
PRIVACY ANSI F19	2 1/2" 2 3/4"	2MM.LCK.0M00 . xx + 2MM.028.0xTx . xx ONLY LOCK + 2MM.028.0Uxx . xx Add thumbturns page Levers_127 + 2MM.028.0Uxx . xx Add thumbturns page Levers_127 + 2MM.028.0Uxx . xx Add thumbturns page Levers_127

.XX = FINISH CODE

- .43 BRIGHT STAINLESS STEEL (ANSI/BHMA 629 - USD32)
- .44 SATIN STAINLESS STEEL (ANSI/BHMA 630 - USD32D)

PVD ON REQUEST

- .83 BLACK SATIN
- Colors on demand, minimum lot to be agreed.
Screws and grub screws not pvd

STAINLESS STEEL POWDER-COATED ON REQUEST

- .40 BLACK RAL 9005 MATT - TO MATCH WITH PBA BLACK ALUMINUM
- .26 BLACK RAL 9005 GLOSSY
- .31 WHITE RAL 9010
- .32 GREY
- .38 CHAMPAGNE
- .39 BRONZE - TO MATCH WITH PBA BRONZE ALUMINUM
- .36 ARCHITECTURAL BRONZE
- .56 MEDIUM BRONZE
- .41 SILVER
- .55 GOLD

- .99 COLORS ON REQUEST TO MATCH ANY RAL #
(screws, grub screws and plastic parts non powder-coated)
available on request depending on quantities

MORTISE LOCKS: SEE TECHNICAL INFORMATION FOR SOLID DOOR SECTION

MORTISE CYLINDERS NOT INCLUDED see page Levers_141 FOR COMPATIBLE MODELS

STANDARD FACEPLATE AND STRIKEPLATE SATIN STAINLESS STEEL.

SPINDLE DEPTH, LEVERS POSITION ON THE LOCKSET AND FIXING (SINGLE OR BACK TO BACK) MUST BE SPECIFIED ORDERING - see page Levers_143

HANDLE FOR MORTISE
GLASS DOORS WITH ALUMINUM PROFILE
OR WOOD AND HM DOORS

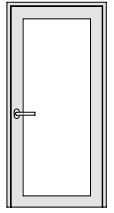

ITEM THESE PRODUCTS CONTRIBUTE TO LEED® CREDITS

2MM.028.0008 . xx

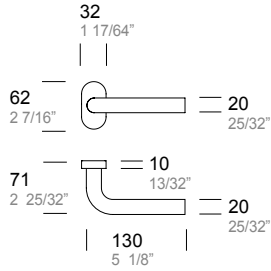

with return spring

2MM.028.0004 . xx

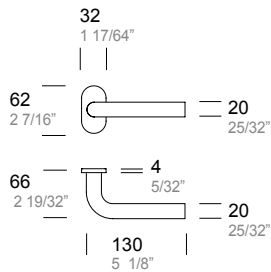

without return spring

.XX = FINISH CODE

- STAINLESS STEEL**
- .43 BRIGHT STAINLESS STEEL (ANSI/BHMA 629 - USD32)
- .44 SATIN STAINLESS STEEL (ANSI/BHMA 630 - USD32D)

PVD ON REQUEST

- .83 BLACK SATIN
- Colors on demand, minimum lot to be agreed.
- Screws and grub screws not pvd

STAINLESS STEEL POWDER-COATED ON REQUEST

- .40 BLACK RAL 9005 MATT - TO MATCH WITH PBA BLACK ALUMINUM
- .26 BLACK RAL 9005 GLOSSY
- .31 WHITE RAL 9010
- .32 GREY
- .38 CHAMPAGNE
- .39 BRONZE - TO MATCH WITH PBA BRONZE ALUMINUM
- .36 ARCHITECTURAL BRONZE
- .56 MEDIUM BRONZE
- .41 SILVER
- .55 GOLD

- .99 COLORS ON REQUEST TO MATCH ANY RAL #
- (screws, grub screws and plastic parts non powder-coated)
- available on request depending on quantities

SPINDLE DEPTH, LEVERS POSITION ON THE LOCKSET AND FIXING
(SINGLE OR BACK TO BACK) MUST BE SPECIFIED ORDERING - see page Levers_143

HANDLE WITH LATCH
WOOD OR HM DOORS



ITEM BACKSET FUNCTION

2MM.028.SA70 . xx	70 mm 2 3/4"	PASSAGE	
2MM.028.SA60 . xx	60 mm 2 3/8"		
latch included			
with return spring			

2MM.028.SB70 . xx	70 mm 2 3/4"	PRIVACY	
2MM.028.SB60 . xx	60 mm 2 3/8"		
latch included			
with return spring			

2MM.028.MA70 . xx	70 mm 2 3/4"	PASSAGE WITH MAGNETIC BOLT	
2MM.028.MA60 . xx	60 mm 2 3/8"		
latch included			
with return spring			

2MM.028.MB70 . xx	70 mm 2 3/4"	PRIVACY WITH MAGNETIC BOLT	
2MM.028.MB60 . xx	60 mm 2 3/8"		
latch included			
with return spring			

.XX = FINISH CODE

- .43 STAINLESS STEEL
- .43 BRIGHT STAINLESS STEEL (ANSI/BHMA 629 - USD32)
- .44 SATIN STAINLESS STEEL (ANSI/BHMA 630 - USD32D)

PVD ON REQUEST

- .83 BLACK SATIN
- Colors on demand, minimum lot to be agreed.
- Screws and grub screws not pvd

STAINLESS STEEL POWDER-COATED ON REQUEST

- .40 BLACK RAL 9005 MATT- TO MATCH WITH PBA BLACK ALUMINUM
- .26 BLACK RAL 9005 GLOSSY
- .31 WHITE RAL 9010
- .32 GREY
- .38 CHAMPAGNE
- .39 BRONZE - TO MATCH WITH PBA BRONZE ALUMINUM
- .36 ARCHITECTURAL BRONZE
- .56 MEDIUM BRONZE
- .41 SILVER
- .55 GOLD

- .99 COLORS ON REQUEST TO MATCH ANY RAL #
(screws, grub screws and plastic parts non powder-coated)
available on request depending on quantities

LATCH DETAILS
page Levers_145

HANDLE DUMMY
WOOD OR HM DOORS

THESE PRODUCTS CONTRIBUTE TO LEED® CREDITS



ITEM BACKSET FUNCTION

2MM.028.0D06 . xx	SINGLE	
2MM.028.C0D6 . xx	PAIR	
dummy		
without return spring		

2MM.028.0D05 . xx	SINGLE	
2MM.028.C0D5 . xx	PAIR	
dummy		
without return spring		



ITEM

YOD.028.xxxx.xx

MATERIALS, FINISHING AND DETAILS

.XX = FINISH CODE

	LEATHER	STAINLESS STEEL	
.4H	BLACK PF	SATIN STAINLESS STEEL (ANSI/BHMA 630 - USD32D)	
.3H	BLACK PF	BRIGHT STAINLESS STEEL (ANSI/BHMA 629 - USD32)	
.4P	BROWN PF	SATIN STAINLESS STEEL (ANSI/BHMA 630 - USD32D)	
.3P	BROWN PF	BRIGHT STAINLESS STEEL (ANSI/BHMA 629 - USD32)	

STAINLESS STEEL POWDER-COATED

.40	BLACK RAL 9005 MATT - TO MATCH WITH PBA	
.26	BLACK ALUMINUM	
.31	WHITE RAL 9005 GLOSSY	
.32	GREY	
.38	CHAMPAGNE	
.39	BRONZE - TO MATCH WITH PBA BRONZE ALUMINUM	
.36	ARCHITECTURAL BRONZE	
.56	MEDIUM BRONZE	
.41	SILVER	
.55	GOLD	
.99	COLORS ON REQUEST TO MATCH ANY RAL # (screws, grub screws and plastic parts non powder-coated). Available on request depending on quantities.	

PVD ON SELECTED ITEMS

.83	BLACK SATIN	
	Colors on demand, minimum lot to be agreed. Screws and grub screws not pvd.	

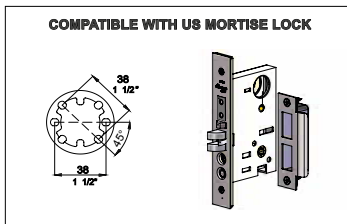
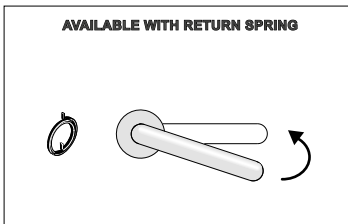

CERTIFICATION LEATHER PF:

THESE PRODUCTS CONTRIBUTE TO **LEED®** CREDITS

THE MANUFACTURER RESERVES THE RIGHT TO ALTER, IMPROVE AND DISCONTINUE ANY FEATURES OF THE PRODUCT (MAKE CHANGES AND IMPROVEMENTS IN DESIGNS AND DIMENSIONS) WITHOUT NOTICE.

ALL DIMENSIONS IN THE CATALOG DRAWINGS ARE APPROXIMATIONS. REQUEST THE APPROPRIATE TECHNICAL DRAWING BEFORE DOOR PREPARATION AND INSTALLATION.

FIXING:

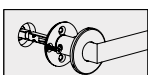

SINGLE SIDE FIXING

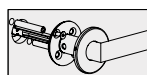

BACK TO BACK FIXING

HANDLE FOR MORTISE
WOOD OR HM DOORS



ITEM THESE PRODUCTS CONTRIBUTE TO **LEED®** CREDITS

YOD.028.0UT8 . xx

mortise

with return spring

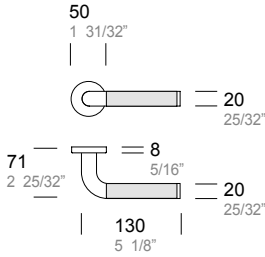

YOD.028.00T4 . xx

mortise

without return spring

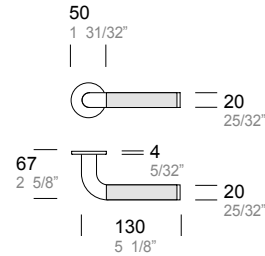

YOD.028.0Uxx . xx

mortise

without return spring

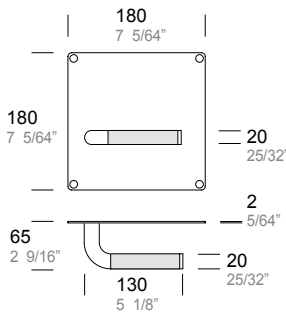

YOD.028.0Uxx . xx

mortise

without return spring

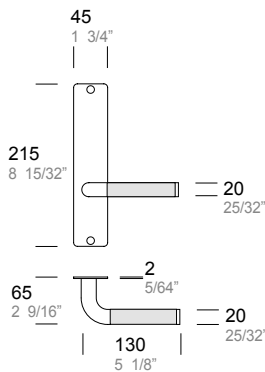

LOCK
WOOD OR HM DOORS

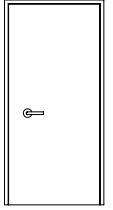

FUNCTION	BACKSET	HOW TO ORDER
PASSAGE ANSI F01	2 1/2" 2 3/4"	2MM.LCK.0A00 . xx + YOD.028.0xTx . xx ONLY LOCK + YOD.028.0Uxx . xx + YOD.028.0Uxx . xx
OFFICE/CORRIDOR ANSI F04	2 1/2" 2 3/4"	2MM.LCK.0F00 . xx + YOD.028.0xTx . xx ONLY LOCK + YOD.028.0Uxx . xx + YOD.028.0Uxx . xx
CLASSROOM ANSI F05	2 1/2" 2 3/4"	2MM.LCK.0G00 . xx + YOD.028.0xTx . xx ONLY LOCK + YOD.028.0Uxx . xx + YOD.028.0Uxx . xx
STOREROOM ANSI F07	2 1/2" 2 3/4"	2MM.LCK.0P00 . xx + YOD.028.0xTx . xx ONLY LOCK + YOD.028.0Uxx . xx + YOD.028.0Uxx . xx
OFFICE/ENTRY ANSI F04 + F13	2 1/2" 2 3/4"	2MM.LCK.0I00 . xx + YOD.028.0xTx . xx ONLY LOCK + YOD.028.0Uxx . xx Add thumbturns page Levers_127 + YOD.028.0Uxx . xx Add thumbturns page Levers_127 + YOD.028.0Uxx . xx Add thumbturns page Levers_127
DORMITORY ANSI F13	2 1/2" 2 3/4"	2MM.LCK.0E00 . xx + YOD.028.0xTx . xx ONLY LOCK + YOD.028.0Uxx . xx Add thumbturns page Levers_127 + YOD.028.0Uxx . xx Add thumbturns page Levers_127 + YOD.028.0Uxx . xx Add thumbturns page Levers_127
PRIVACY ANSI F19	2 1/2" 2 3/4"	2MM.LCK.0M00 . xx + YOD.028.0xTx . xx ONLY LOCK + YOD.028.0Uxx . xx Add thumbturns page Levers_127 + YOD.028.0Uxx . xx Add thumbturns page Levers_127 + YOD.028.0Uxx . xx Add thumbturns page Levers_127

.XX = FINISH CODE

- | | |
|----------------|--|
| LEATHER | STAINLESS STEEL |
| .4H BLACK PF | SATIN STAINLESS STEEL (ANSI/BHMA 630 - USD32D) |
| .3H BLACK PF | BRIGHT STAINLESS STEEL (ANSI/BHMA 629 - USD32) |
| .4P BROWN PF | SATIN STAINLESS STEEL (ANSI/BHMA 630 - USD32D) |
| .3P BROWN PF | BRIGHT STAINLESS STEEL (ANSI/BHMA 629 - USD32) |

.83 PVD ON REQUEST

BLACK SATIN
Colors on demand, minimum lot to be agreed.
Screws and grub screws not pvd

STAINLESS STEEL POWDER-COATED ON REQUEST

- | | |
|--|---|
| .40 BLACK RAL 9005 MATT - TO MATCH WITH PBA BLACK ALUMINUM | .99 COLORS ON REQUEST TO MATCH ANY RAL #
(screws, grub screws and plastic parts non powder-coated)
available on request depending on quantities |
| .26 BLACK RAL 9005 GLOSSY | MORTISE LOCKS: SEE TECHNICAL INFORMATION FOR SOLID DOOR SECTION
MORTISE CYLINDERS NOT INCLUDED see page Levers_141
FOR COMPATIBLE MODELS |
| .31 WHITE RAL 9010 | STANDARD FACEPLATE AND STRIKEPLATE SATIN STAINLESS STEEL. |
| .32 GREY | SPINDLE DEPTH, LEVERS POSITION ON THE LOCKSET AND FIXING
(SINGLE OR BACK TO BACK) MUST BE SPECIFIED ORDERING
see page Levers_143 |
| .38 CHAMPAGNE | |
| .39 BRONZE - TO MATCH WITH PBA BRONZE ALUMINUM | |
| .36 ARCHITECTURAL BRONZE | |
| .56 MEDIUM BRONZE | |
| .41 SILVER | |
| .55 GOLD | |

HANDLE FOR MORTISE

GLASS DOORS WITH ALUMINUM PROFILE OR WOOD AND HM DOORS

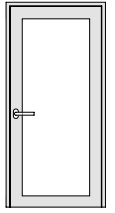

ITEM THESE PRODUCTS CONTRIBUTE TO LEED® CREDITS

YOD.028.0008 . xx

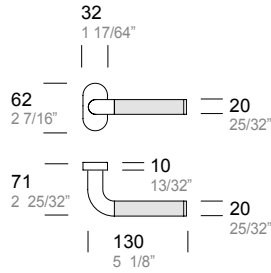

with return spring

YOD.028.0004 . xx

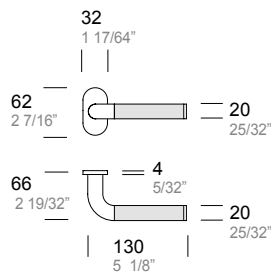

without return spring

.XX = FINISH CODE

LEATHER	STAINLESS STEEL
.4H BLACK PF	SATIN STAINLESS STEEL (ANSI/BHMA 630 - USD32D)
.3H BLACK PF	BRIGHT STAINLESS STEEL (ANSI/BHMA 629 - USD32)
.4P BROWN PF	SATIN STAINLESS STEEL (ANSI/BHMA 630 - USD32D)
.3P BROWN PF	BRIGHT STAINLESS STEEL (ANSI/BHMA 629 - USD32)

PVD ON REQUEST

.83 BLACK SATIN
Colors on demand, minimum lot to be agreed.
Screws and grub screws not pvd

STAINLESS STEEL POWDER-COATED ON REQUEST

.40 BLACK RAL 9005 MATT - TO MATCH WITH PBA BLACK ALUMINUM
.26 BLACK RAL 9005 GLOSSY
.31 WHITE RAL 9010
.32 GREY
.38 CHAMPAGNE
.39 BRONZE - TO MATCH WITH PBA BRONZE ALUMINUM
.36 ARCHITECTURAL BRONZE
.56 MEDIUM BRONZE
.41 SILVER
.55 GOLD

.99 COLORS ON REQUEST TO MATCH ANY RAL #
(screws, grub screws and plastic parts non powder-coated)
available on request depending on quantities

SPINDLE DEPTH, LEVERS POSITION ON THE LOCKSET AND FIXING
(SINGLE OR BACK TO BACK) MUST BE SPECIFIED ORDERING
see page Levers_143

ANTIMICROBIAL
COPPER



ITEM

2MU.028.xxxx.4R

MATERIALS, FINISHING AND DETAILS

FINISH CODE

	COPPER	STAINLESS STEEL	
.4R	SATIN COPPER	SATIN STAINLESS STEEL (ANSI/BHMA 630 - USD32D)	

AVAILABLE WITH RETURN SPRING

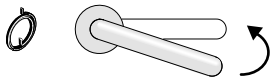

COMPATIBLE WITH US MORTISE LOCK

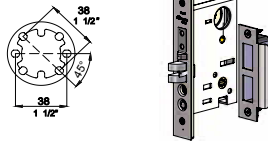

THESE PRODUCTS CONTRIBUTE TO **LEED®** CREDITS

THE MANUFACTURER RESERVES THE RIGHT TO ALTER, IMPROVE AND DISCONTINUE ANY FEATURES OF THE PRODUCT (MAKE CHANGES AND IMPROVEMENTS IN DESIGNS AND DIMENSIONS) WITHOUT NOTICE.

ALL DIMENSIONS IN THE CATALOG DRAWINGS ARE APPROXIMATIONS. REQUEST THE APPROPRIATE TECHNICAL DRAWING BEFORE DOOR PREPARATION AND INSTALLATION.

FIXING:

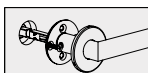

SINGLE SIDE FIXING

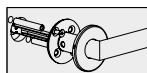

BACK TO BACK FIXING

HANDLE FOR MORTISE
WOOD OR HM DOORS

ANTIMICROBIAL
COPPER



ITEM THESE PRODUCTS CONTRIBUTE TO LEED® CREDITS

2MU.028.0UT8 .4R

mortise

with return spring

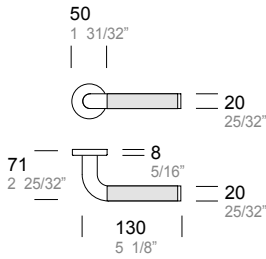

2MU.028.00T4 .4R

mortise

without return spring

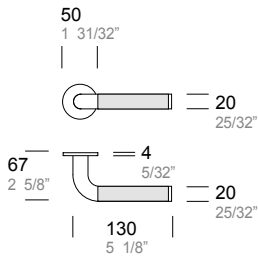

- Stainless Steel
- Satin Copper

LOCK
WOOD OR HM DOORS

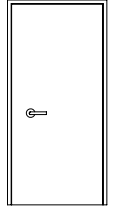

FUNCTION	BACKSET	HOW TO ORDER
PASSAGE ANSI F01 	2 1/2" 2 3/4"	2MM.LCK.0A00 . xx + 2MU.028.0xTx . 4R ONLY LOCK
OFFICE/CORRIDOR ANSI F04 	2 1/2" 2 3/4"	2MM.LCK.0F00 . xx + 2MU.028.0xTx . 4R ONLY LOCK
CLASSROOM ANSI F05 	2 1/2" 2 3/4"	2MM.LCK.0G00 . xx + 2MU.028.0xTx . 4R ONLY LOCK
STOREROOM ANSI F07 	2 1/2" 2 3/4"	2MM.LCK.0P00 . xx + 2MU.028.0xTx . 4R ONLY LOCK
OFFICE/ENTRY ANSI F04 + F13 	2 1/2" 2 3/4"	2MM.LCK.0I00 . xx + 2MU.028.0xTx . 4R ONLY LOCK Add thumbturns page Levers_127
DORMITORY ANSI F13 	2 1/2" 2 3/4"	2MM.LCK.0E00 . xx + 2MU.028.0xTx . 4R ONLY LOCK Add thumbturns page Levers_127
PRIVACY ANSI F19 	2 1/2" 2 3/4"	2MM.LCK.0M00 . xx + YOD.028.0xTx . 4R ONLY LOCK Add thumbturns page Levers_127

FINISH CODE

- COPPER**
- STAINLESS STEEL**
- .4R SATIN COPPER
- SATIN STAINLESS STEEL (ANSI/BHMA 630 - USD32D)

MORTISE LOCKS: SEE TECHNICAL INFORMATION FOR SOLID DOOR SECTION

MORTISE CYLINDERS NOT INCLUDED see page Mortise_6
FOR COMPATIBLE MODELS

STANDARD FACEPLATE AND STRIKEPLATE SATIN STAINLESS STEEL.

SPINDLE DEPTH, LEVERS POSITION ON THE LOCKSET AND FIXING
(SINGLE OR BACK TO BACK) MUST BE SPECIFIED ORDERING - see page Levers_143



TITLE 24 *
COMPLIANCE
AVAILABLE

See pag. Levers_144



ITEM

2MM.28B.xxxx.xx











MATERIALS, FINISHING AND DETAILS

.XX = FINISH CODE

STAINLESS STEEL

- .44 SATIN STAINLESS STEEL (ANSI/BHMA 630 - USD32D) 
- .43 BRIGHT STAINLESS STEEL (ANSI/BHMA 629 - USD32) 

STAINLESS STEEL POWDER-COATED

- .40 BLACK RAL 9005 MATT - TO MATCH WITH PBA 
- .26 BLACK ALUMINUM 
- .31 WHITE RAL 9005 GLOSSY 
- .32 GREY 
- .38 CHAMPAGNE 
- .39 BRONZE - TO MATCH WITH PBA BRONZE ALUMINUM 
- .36 ARCHITECTURAL BRONZE 
- .56 MEDIUM BRONZE 
- .41 SILVER 
- .55 GOLD 
- .99 COLORS ON REQUEST TO MATCH ANY RAL #
(screws, grub screws and plastic parts non powder-coated).
Available on request depending on quantities.

PVD ON SELECTED ITEMS

- .83 BLACK SATIN 
Colors on demand, minimum lot to be agreed.
Screws and grub screws not pvd.

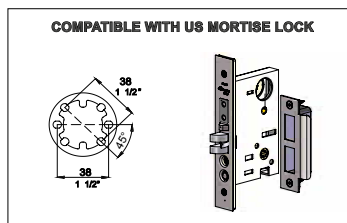
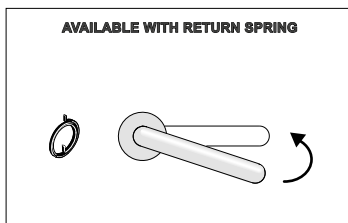

THESE PRODUCTS CONTRIBUTE TO LEED® CREDITS

THE MANUFACTURER RESERVES THE RIGHT TO ALTER, IMPROVE AND DISCONTINUE ANY FEATURES OF THE PRODUCT (MAKE CHANGES AND IMPROVEMENTS IN DESIGNS AND DIMENSIONS) WITHOUT NOTICE.

ALL DIMENSIONS IN THE CATALOG DRAWINGS ARE APPROXIMATIONS. REQUEST THE APPROPRIATE TECHNICAL DRAWING BEFORE DOOR PREPARATION AND INSTALLATION.

FIXING:

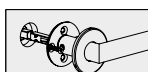

SINGLE SIDE FIXING

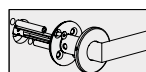

BACK TO BACK FIXING

HANDLE FOR MORTISE
WOOD OR HM DOORS



TITLE 24*
COMPLIANCE
AVAILABLE



Declare.

ITEM THESE PRODUCTS CONTRIBUTE TO LEED® CREDITS

2MM.28U.0UT8 . xx

- mortise
- with return spring

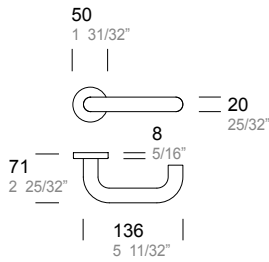

2MM.28B.00T4 . xx

- mortise
- without return spring

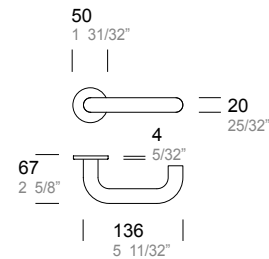

2MM.28B.0Uxx . xx

- mortise
- without return spring

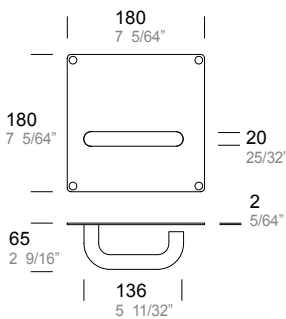

2MM.028.0Uxx . xx

- mortise
- without return spring

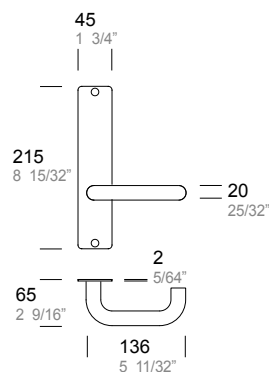

LOCK
WOOD OR HM DOORS



TITLE 24*
COMPLIANCE
AVAILABLE

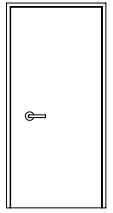

FUNCTION BACKSET HOW TO ORDER

PASSAGE
ANSI F01

2 1/2"
2 3/4"

2MM.LCK.0A00 . xx + ONLY LOCK

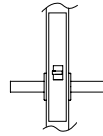

+ **2MM.28B.0xTx . xx**

+ **2MM.28B.0Uxx . xx**

+ **2MM.28B.0Uxx . xx**

OFFICE/CORRIDOR
ANSI F04

2 1/2"
2 3/4"

2MM.LCK.0F00 . xx + ONLY LOCK

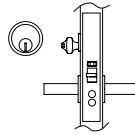

+ **2MM.28B.0xTx . xx**

+ **2MM.28B.0Uxx . xx**

+ **2MM.28B.0Uxx . xx**

CLASSROOM
ANSI F05

2 1/2"
2 3/4"

2MM.LCK.0G00 . xx + ONLY LOCK

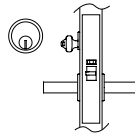

+ **2MM.28B.0xTx . xx**

+ **2MM.28B.0Uxx . xx**

+ **2MM.28B.0Uxx . xx**

STOREROOM
ANSI F07

2 1/2"
2 3/4"

2MM.LCK.0P00 . xx + ONLY LOCK

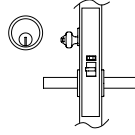

+ **2MM.28B.0xTx . xx**

+ **2MM.28B.0Uxx . xx**

+ **2MM.28B.0Uxx . xx**

OFFICE/ENTRY
ANSI F04 + F13

2 1/2"
2 3/4"

2MM.LCK.0I00 . xx + ONLY LOCK

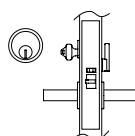

+ **2MM.28B.0xTx . xx**

+ **2MM.28B.0Uxx . xx**

+ **2MM.28B.0Uxx . xx**

+ Add thumbturns page Levers_127

DORMITORY
ANSI F13

2 1/2"
2 3/4"

2MM.LCK.0E00 . xx + ONLY LOCK

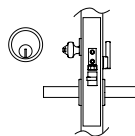

+ **2MM.28B.0xTx . xx**

+ **2MM.28B.0Uxx . xx**

+ **2MM.28B.0Uxx . xx**

+ Add thumbturns page Levers_127

PRIVACY
ANSI F19

2 1/2"
2 3/4"

2MM.LCK.0M00 . xx + ONLY LOCK

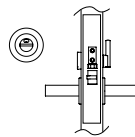

+ **2MM.28B.0xTx . xx**

+ **2MM.28B.0Uxx . xx**

+ **2MM.28B.0Uxx . xx**

+ Add thumbturns page Levers_127

.XX = FINISH CODE

- STAINLESS STEEL
- .43 BRIGHT STAINLESS STEEL (ANSI/BHMA 629 - USD32)
- .44 SATIN STAINLESS STEEL (ANSI/BHMA 630 - USD32D)

PVD ON REQUEST

- .83 BLACK SATIN
- Colors on demand, minimum lot to be agreed.
- Screws and grub screws not pvd

* SEE TECHNICAL INFORMATION FOR TITLE 24 INFORMATION
pag. Levers_144

STAINLESS STEEL POWDER-COATED ON REQUEST

- .40 BLACK RAL 9005 MATT - TO MATCH WITH PBA BLACK ALUMINUM
- .26 BLACK RAL 9005 GLOSSY
- .31 WHITE RAL 9010
- .32 GREY
- .38 CHAMPAGNE
- .39 BRONZE - TO MATCH WITH PBA BRONZE ALUMINUM
- .36 ARCHITECTURAL BRONZE
- .56 MEDIUM BRONZE
- .41 SILVER
- .55 GOLD

.99 COLORS ON REQUEST TO MATCH ANY RAL #
(screws, grub screws and plastic parts non powder-coated)
available on request depending on quantities

MORTISE LOCKS: SEE TECHNICAL INFORMATION FOR SOLID DOOR SECTION

MORTISE CYLINDERS NOT INCLUDED see page Levers_141
FOR COMPATIBLE MODELS

STANDARD FACEPLATE AND STRIKEPLATE SATIN STAINLESS STEEL.

SPINDLE DEPTH, LEVERS POSITION ON THE LOCKSET AND FIXING
(SINGLE OR BACK TO BACK) MUST BE SPECIFIED ORDERING - see page Levers_143

HANDLE FOR MORTISE
GLASS DOORS WITH ALUMINUM PROFILE
OR WOOD AND HM DOORS

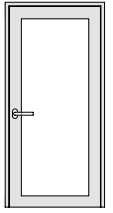

ITEM THESE PRODUCTS CONTRIBUTE TO **LEED®** CREDITS

2MM.28B.0008 . xx

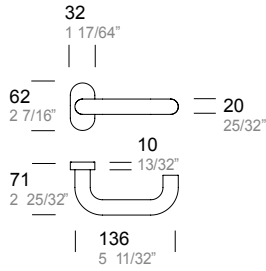

Ø with return spring

2MM.28B.0004 . xx

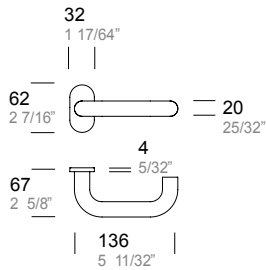

Ø without return spring

.XX = FINISH CODE

- STAINLESS STEEL**
- .43 BRIGHT STAINLESS STEEL (ANSI/BHMA 629 - USD32)
- .44 SATIN STAINLESS STEEL (ANSI/BHMA 630 - USD32D)

PVD ON REQUEST

- .83 BLACK SATIN
- Colors on demand, minimum lot to be agreed.
- Screws and grub screws not pvd

STAINLESS STEEL POWDER-COATED ON REQUEST

- .40 BLACK RAL 9005 MATT - TO MATCH WITH PBA BLACK ALUMINUM
- .26 BLACK RAL 9005 GLOSSY
- .31 WHITE RAL 9010
- .32 GREY
- .38 CHAMPAGNE
- .39 BRONZE - TO MATCH WITH PBA BRONZE ALUMINUM
- .36 ARCHITECTURAL BRONZE
- .56 MEDIUM BRONZE
- .41 SILVER
- .55 GOLD

- .99 COLORS ON REQUEST TO MATCH ANY RAL #
(screws, grub screws and plastic parts non powder-coated)
available on request depending on quantities

* SEE TECHNICAL INFORMATION FOR TITLE 24 INFORMATION
pag. Levers_144

SPINDLE DEPTH, LEVERS POSITION ON THE LOCKSET AND FIXING
(SINGLE OR BACK TO BACK) MUST BE SPECIFIED ORDERING - see page Levers_143

HANDLE WITH LATCH
WOOD OR HM DOORS



TITLE 24



ITEM BACKSET FUNCTION

2MM.28B.SA70 . xx	70 mm 2 3/4"	PASSAGE	
2MM.28B.SA60 . xx	60 mm 2 3/8"		
latch included			
with return spring			

2MM.28B.SB70 . xx	70 mm 2 3/4"	PRIVACY	
2MM.28B.SB60 . xx	60 mm 2 3/8"		
latch included			
with return spring			

2MM.28B.MA70 . xx	70 mm 2 3/4"	PASSAGE WITH MAGNETIC BOLT	
2MM.28B.MA60 . xx	60 mm 2 3/8"		
latch included			
with return spring			

2MM.28B.MB70 . xx	70 mm 2 3/4"	PRIVACY WITH MAGNETIC BOLT	
2MM.28B.MB60 . xx	60 mm 2 3/8"		
latch included			
with return spring			

.XX = FINISH CODE

- .43 STAINLESS STEEL
- .43 BRIGHT STAINLESS STEEL (ANSI/BHMA 629 - USD32)
- .44 SATIN STAINLESS STEEL (ANSI/BHMA 630 - USD32D)

PVD ON REQUEST

- .83 BLACK SATIN
- Colors on demand, minimum lot to be agreed.
- Screws and grub screws not pvd

STAINLESS STEEL POWDER-COATED ON REQUEST

- .40 BLACK RAL 9005 MATT - TO MATCH WITH PBA BLACK ALUMINUM
- .26 BLACK RAL 9005 GLOSSY
- .31 WHITE RAL 9010
- .32 GREY
- .38 CHAMPAGNE
- .39 BRONZE - TO MATCH WITH PBA BRONZE ALUMINUM
- .36 ARCHITECTURAL BRONZE
- .56 MEDIUM BRONZE
- .41 SILVER
- .55 GOLD

- .99 COLORS ON REQUEST TO MATCH ANY RAL #
- (screws, grub screws and plastic parts non powder-coated)
- available on request depending on quantities

LATCH DETAILS
page Levers_145

HANDLE DUMMY
WOOD OR HM DOORS

THESE PRODUCTS CONTRIBUTE TO LEED® CREDITS



TITLE 24



ITEM BACKSET FUNCTION

2MM.28B.OD06 . xx	SINGLE	
2MM.28B.COD6 . xx	PAIR	
dummy		
without return spring		

2MM.28B.OD05 . xx	SINGLE	
2MM.28B.COD5 . xx	PAIR	
dummy		
without return spring		



ITEM

3CC.326.0000.xx

MATERIALS, FINISHING AND DETAILS

.XX = FINISH CODE

POLYAMIDE 6

- .10 BLACK
- .01 WHITE
- .07 GREY
- .09 RED



Articles available with minimum order quantity for white, grey and red colors

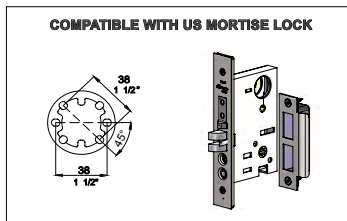

THESE PRODUCTS CONTRIBUTE TO **LEED®** CREDITS

THE MANUFACTURER RESERVES THE RIGHT TO ALTER, IMPROVE AND DISCONTINUE ANY FEATURES OF THE PRODUCT (MAKE CHANGES AND IMPROVEMENTS IN DESIGNS AND DIMENSIONS) WITHOUT NOTICE.

ALL DIMENSIONS IN THE CATALOG DRAWINGS ARE APPROXIMATIONS. REQUEST THE APPROPRIATE TECHNICAL DRAWING BEFORE DOOR PREPARATION AND INSTALLATION.

FIXING:

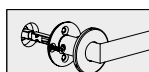

SINGLE SIDE FIXING

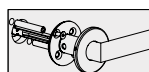

BACK TO BACK FIXING

HANDLE FOR MORTISE
WOOD OR HM DOORS



ITEM THESE PRODUCTS CONTRIBUTE TO LEED® CREDITS

3CC.326.0000 . xx



mortise

without return spring

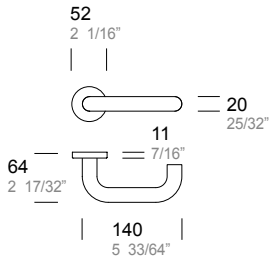

LOCK
WOOD OR HM DOORS

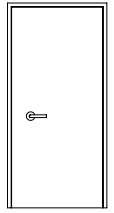

FUNCTION BACKSET HOW TO ORDER

PASSAGE ANSI F01 2 1/2" 2 3/4" **2MM.LCK.0A00 . xx** + **3CC.326.0000 . xx**
ONLY LOCK

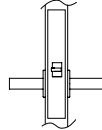

OFFICE/CORRIDOR ANSI F04 2 1/2" 2 3/4" **2MM.LCK.0F00 . xx** + **3CC.326.0000 . xx**
ONLY LOCK

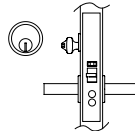

CLASSROOM ANSI F05 2 1/2" 2 3/4" **2MM.LCK.0G00 . xx** + **3CC.326.0000 . xx**
ONLY LOCK

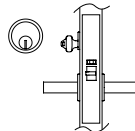

STOREROOM ANSI F07 2 1/2" 2 3/4" **2MM.LCK.0P00 . xx** + **3CC.326.0000 . xx**
ONLY LOCK

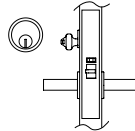

OFFICE/ENTRY ANSI F04 + F13 2 1/2" 2 3/4" **2MM.LCK.0I00 . xx** + **3CC.326.0000 . xx**
ONLY LOCK Add thumbturns page Levers_127

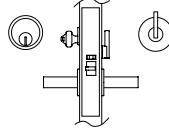

DORMITORY ANSI F13 2 1/2" 2 3/4" **2MM.LCK.0E00 . xx** + **3CC.326.0000 . xx**
ONLY LOCK Add thumbturns page Levers_127

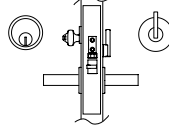

PRIVACY ANSI F19 2 1/2" 2 3/4" **2MM.LCK.0M00 . xx** + **3CC.326.0000 . xx**
ONLY LOCK Add thumbturns page Levers_127

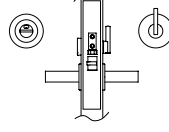

.XX = FINISH CODE

.10 POLYAMIDE 6 STANDARD
BLACK

POLYAMIDE 6 UPON REQUEST
(minimum lot to be agreed)

.01 WHITE
.07 GREY
.09 RED

MORTISE LOCKS: SEE TECHNICAL INFORMATION FOR SOLID DOOR SECTION

MORTISE CYLINDERS NOT INCLUDED see page Mortise_6
FOR COMPATIBLE MODELS

STANDARD FACEPLATE AND STRIKEPLATE SATIN STAINLESS STEEL.

SPINDLE DEPTH, LEVERS POSITION ON THE LOCKSET AND FIXING
(SINGLE OR BACK TO BACK) MUST BE SPECIFIED ORDERING - see page Levers_143

HANDLE FOR MORTISE

GLASS DOORS WITH ALUMINIUM PROFILE
OR WOOD AND HM DOORS

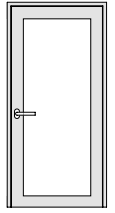

ITEM THESE PRODUCTS CONTRIBUTE TO **LEED®** CREDITS

3CC.328.0000 . xx

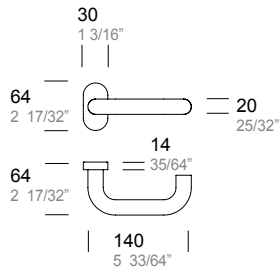

~~Ø~~ without return spring

.XX = FINISH CODE

.10 POLYAMIDE 6 STANDARD
BLACK

POLYAMIDE 6 UPON REQUEST
(minimum lot to be agreed)

.01 WHITE
.07 GREY
.09 RED

SPINDLE DEPTH, LEVERS POSITION ON THE LOCKSET AND FIXING
(SINGLE OR BACK TO BACK) MUST BE SPECIFIED ORDERING - see page Levers_141





ITEM

2MM.173.xxTx.xx











MATERIALS, FINISHING AND DETAILS

.XX = FINISH CODE

STAINLESS STEEL

- .44 SATIN STAINLESS STEEL (ANSI/BHMA 630 - USD32D) 
- .43 BRIGHT STAINLESS STEEL (ANSI/BHMA 629 - USD32) 

STAINLESS STEEL POWDER-COATED

- .40 BLACK RAL 9005 MATT - TO MATCH WITH PBA 
- .26 BLACK ALUMINUM 
- .31 WHITE RAL 9005 GLOSSY 
- .32 GREY 
- .38 CHAMPAGNE 
- .39 BRONZE - TO MATCH WITH PBA BRONZE ALUMINUM 
- .36 ARCHITECTURAL BRONZE 
- .56 MEDIUM BRONZE 
- .41 SILVER 
- .55 GOLD 
- .99 COLORS ON REQUEST TO MATCH ANY RAL #
(screws, grub screws and plastic parts non powder-coated).
Available on request depending on quantities.

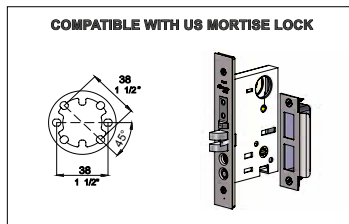

THESE PRODUCTS CONTRIBUTE TO LEED® CREDITS

THE MANUFACTURER RESERVES THE RIGHT TO ALTER, IMPROVE AND DISCONTINUE ANY FEATURES OF THE PRODUCT (MAKE CHANGES AND IMPROVEMENTS IN DESIGNS AND DIMENSIONS) WITHOUT NOTICE.

ALL DIMENSIONS IN THE CATALOG DRAWINGS ARE APPROXIMATIONS. REQUEST THE APPROPRIATE TECHNICAL DRAWING BEFORE DOOR PREPARATION AND INSTALLATION.

FIXING:

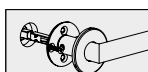

SINGLE SIDE FIXING

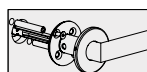

BACK TO BACK FIXING

HANDLE FOR MORTISE
WOOD OR HM DOORS

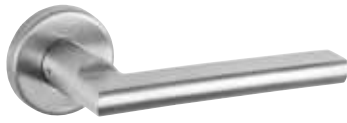

ITEM THESE PRODUCTS CONTRIBUTE TO LEED® CREDITS

2MM.173.0UT8 . xx

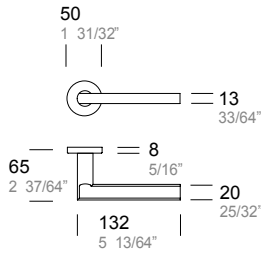

mortise

with return spring

2MM.173.00T4 . xx

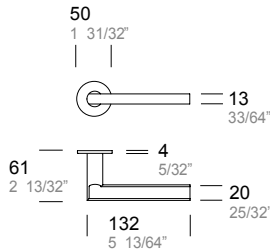

mortise

without return spring

LOCK
WOOD OR HM DOORS

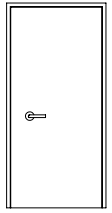
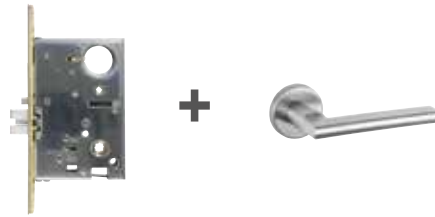

FUNCTION	BACKSET	HOW TO ORDER
PASSAGE ANSI F01 	2 1/2" 2 3/4"	2MM.LCK.0A00 . xx + 2MM.173.0xTx . xx ONLY LOCK
OFFICE/CORRIDOR ANSI F04 	2 1/2" 2 3/4"	2MM.LCK.0F00 . xx + 2MM.173.0xTx . xx ONLY LOCK
CLASSROOM ANSI F05 	2 1/2" 2 3/4"	2MM.LCK.0G00 . xx + 2MM.173.0xTx . xx ONLY LOCK
STOREROOM ANSI F07 	2 1/2" 2 3/4"	2MM.LCK.0P00 . xx + 2MM.173.0xTx . xx ONLY LOCK
OFFICE/ENTRY ANSI F04 + F13 	2 1/2" 2 3/4"	2MM.LCK.0I00 . xx + 2MM.173.0xTx . xx ONLY LOCK Add thumbturns page Levers_127
DORMITORY ANSI F13 	2 1/2" 2 3/4"	2MM.LCK.0E00 . xx + 2MM.173.0xTx . xx ONLY LOCK Add thumbturns page Levers_127
PRIVACY ANSI F19 	2 1/2" 2 3/4"	2MM.LCK.0M00 . xx + 2MM.173.0xTx . xx ONLY LOCK Add thumbturns page Levers_127

.XX = FINISH CODE

- STAINLESS STEEL**
- .43 BRIGHT STAINLESS STEEL (ANSI/BHMA 629 - USD32)
 - .44 SATIN STAINLESS STEEL (ANSI/BHMA 630 - USD32D)
- .99 COLORS ON REQUEST TO MATCH ANY RAL #
(screws, grub screws and plastic parts non powder-coated)
available on request depending on quantities

- STAINLESS STEEL POWDER-COATED ON REQUEST**
- .40 BLACK RAL 9005 MATT - TO MATCH WITH PBA BLACK ALUMINUM
 - .26 BLACK RAL 9005 GLOSSY
 - .31 WHITE RAL 9010
 - .32 GREY
 - .38 CHAMPAGNE
 - .39 BRONZE - TO MATCH WITH PBA BRONZE ALUMINUM
 - .36 ARCHITECTURAL BRONZE
 - .56 MEDIUM BRONZE
 - .41 SILVER
 - .55 GOLD

MORTISE LOCKS: SEE TECHNICAL INFORMATION FOR SOLID DOOR SECTION
MORTISE CYLINDERS NOT INCLUDED see page Levers_141
FOR COMPATIBLE MODELS
STANDARD FACEPLATE AND STRIKEPLATE SATIN STAINLESS STEEL.
SPINDLE DEPTH, LEVERS POSITION ON THE LOCKSET AND FIXING
(SINGLE OR BACK TO BACK) MUST BE SPECIFIED ORDERING - see page Levers_143



ITEM

2AM.173.xxxx.xx

MATERIALS, FINISHING AND DETAILS

.XX = FINISH CODE

SATIN ANODIZED ALUMINUM

.67 BRONZE

.68 BLACK

.69 SILVER



DIFFERENCES IN THE FINISHING OF (DIFFERENT) COMPONENTS ARE DUE TO THE DIFFERENT PRODUCTION METHODS. THESE VARIATIONS ARE NOT CONSIDERED DEFECTS AND ARE A NATURAL RESULT OF THE FINISHING PROCESS.

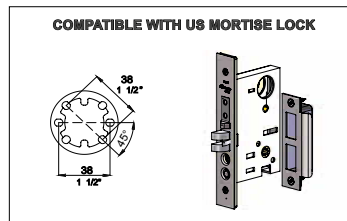

THESE PRODUCTS CONTRIBUTE TO **LEED®** CREDITS

THE MANUFACTURER RESERVES THE RIGHT TO ALTER, IMPROVE AND DISCONTINUE ANY FEATURES OF THE PRODUCT (MAKE CHANGES AND IMPROVEMENTS IN DESIGNS AND DIMENSIONS) WITHOUT NOTICE.

ALL DIMENSIONS IN THE CATALOG DRAWINGS ARE APPROXIMATIONS. REQUEST THE APPROPRIATE TECHNICAL DRAWING BEFORE DOOR PREPARATION AND INSTALLATION.

FIXING:

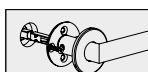

SINGLE SIDE FIXING

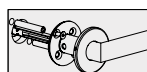

BACK TO BACK FIXING

HANDLE FOR MORTISE
WOOD OR HM DOORS



ITEM THESE PRODUCTS CONTRIBUTE TO LEED® CREDITS



2AM.173.0UT8 . xx

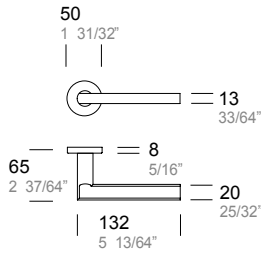

mortise

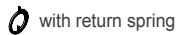

with return spring

2AM.173.00T4 . xx

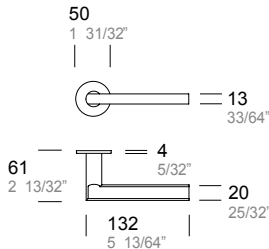

mortise

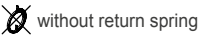

without return spring

LOCK
WOOD OR HM DOORS

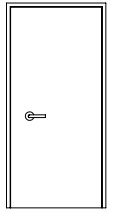

FUNCTION	BACKSET	HOW TO ORDER
PASSAGE ANSI F01	2 1/2" 2 3/4"	2MM.LCK.0A00 . xx + 2AM.173.0xTx . xx ONLY LOCK
OFFICE/CORRIDOR ANSI F04	2 1/2" 2 3/4"	2MM.LCK.0F00 . xx + 2AM.173.0xTx . xx ONLY LOCK
CLASSROOM ANSI F05	2 1/2" 2 3/4"	2MM.LCK.0G00 . xx + 2AM.173.0xTx . xx ONLY LOCK
STOREROOM ANSI F07	2 1/2" 2 3/4"	2MM.LCK.0P00 . xx + 2AM.173.0xTx . xx ONLY LOCK
OFFICE/ENTRY ANSI F04 + F13	2 1/2" 2 3/4"	2MM.LCK.0I00 . xx + 2AM.173.0xTx . xx ONLY LOCK Add thumbturns page Levers_127
DORMITORY ANSI F13	2 1/2" 2 3/4"	2MM.LCK.0E00 . xx + 2AM.173.0xTx . xx ONLY LOCK Add thumbturns page Levers_127
PRIVACY ANSI F19	2 1/2" 2 3/4"	2MM.LCK.0M00 . xx + 2AM.173.0xTx . xx ONLY LOCK Add thumbturns page Levers_127

.XX = FINISH CODE

- .67 SATIN ANODIZED ALUMINUM
- .68 BRONZE
- .69 BLACK
- .69 SILVER

DIFFERENCES IN THE FINISHING OF (DIFFERENT) COMPONENTS ARE DUE TO THE DIFFERENT PRODUCTION METHODS. THESE VARIATIONS ARE NOT CONSIDERED DEFECTS AND ARE A NATURAL RESULT OF THE FINISHING PROCESS.

MORTISE LOCKS: SEE TECHNICAL INFORMATION FOR SOLID DOOR SECTION
MORTISE CYLINDERS NOT INCLUDED see page Levers_141
FOR COMPATIBLE MODELS

STANDARD FACEPLATE AND STRIKEPLATE SATIN STAINLESS STEEL.

SPINDLE DEPTH, LEVERS POSITION ON THE LOCKSET AND FIXING (SINGLE OR BACK TO BACK) MUST BE SPECIFIED ORDERING - see page Levers_143



ITEM

2AM.173.ULT8.68

MATERIALS, FINISHING AND DETAILS

.XX = FINISH CODE

	SATIN ANODIZED ALUMINUM	LEATHER	
.68	BLACK	BLACK	

DIFFERENCES IN THE FINISHING OF (DIFFERENT) COMPONENTS ARE DUE TO THE DIFFERENT PRODUCTION METHODS. THESE VARIATIONS ARE NOT CONSIDERED DEFECTS AND ARE A NATURAL RESULT OF THE FINISHING PROCESS.

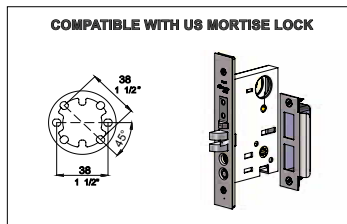
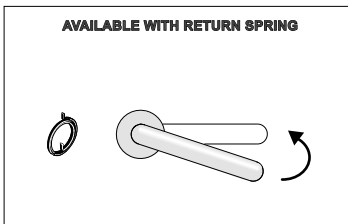

CERTIFICATION LEATHER PF:
THESE PRODUCTS CONTRIBUTE TO LEED® CREDITS

THE MANUFACTURER RESERVES THE RIGHT TO ALTER, IMPROVE AND DISCONTINUE ANY FEATURES OF THE PRODUCT (MAKE CHANGES AND IMPROVEMENTS IN DESIGNS AND DIMENSIONS) WITHOUT NOTICE.

ALL DIMENSIONS IN THE CATALOG DRAWINGS ARE APPROXIMATIONS. REQUEST THE APPROPRIATE TECHNICAL DRAWING BEFORE DOOR PREPARATION AND INSTALLATION.

FIXING:

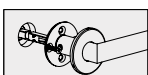

SINGLE SIDE FIXING

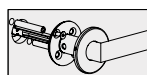

BACK TO BACK FIXING

HANDLE FOR MORTISE
WOOD OR HM DOORS



ITEM THESE PRODUCTS CONTRIBUTE TO **LEED®** CREDITS

2AM.173.ULT8.68

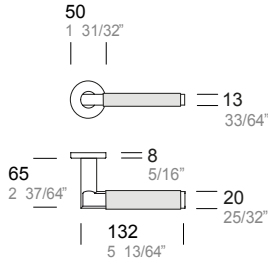
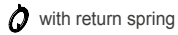

- Aluminium
- Leather

LOCK
WOOD OR HM DOORS



FUNCTION BACKSET HOW TO ORDER

PASSAGE ANSI F01 2 1/2" 2 3/4" **2MM.LCK.0A00 . xx +** **2AM.173.ULT8.68**
ONLY LOCK

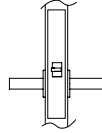

OFFICE/CORRIDOR ANSI F04 2 1/2" 2 3/4" **2MM.LCK.0F00 . xx +** **2AM.173.ULT8.68**
ONLY LOCK

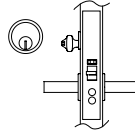

CLASSROOM ANSI F05 2 1/2" 2 3/4" **2MM.LCK.0G00 . xx +** **2AM.173.ULT8.68**
ONLY LOCK

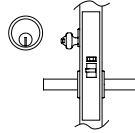

STOREROOM ANSI F07 2 1/2" 2 3/4" **2MM.LCK.0P00 . xx +** **2AM.173.ULT8.68**
ONLY LOCK

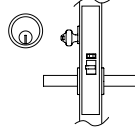

OFFICE/ENTRY ANSI F04 + F13 2 1/2" 2 3/4" **2MM.LCK.0I00 . xx +** **2AM.173.ULT8.68**
ONLY LOCK Add thumbturns page Levers_127

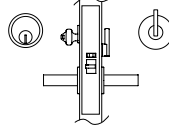

DORMITORY ANSI F13 2 1/2" 2 3/4" **2MM.LCK.0E00 . xx +** **2AM.173.ULT8.68**
ONLY LOCK Add thumbturns page Levers_127

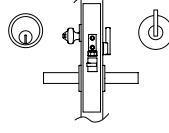

PRIVACY ANSI F19 2 1/2" 2 3/4" **2MM.LCK.0M00 . xx +** **2AM.173.ULT8.68**
ONLY LOCK Add thumbturns page Levers_127

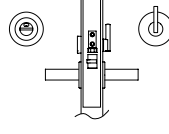

.XX = FINISH CODE

SATIN ANODIZED ALUMINUM
BLACK

LEATHER
BLACK

DIFFERENCES IN THE FINISHING OF (DIFFERENT) COMPONENTS ARE DUE TO THE DIFFERENT PRODUCTION METHODS. THESE VARIATIONS ARE NOT CONSIDERED DEFECTS AND ARE A NATURAL RESULT OF THE FINISHING PROCESS.

MORTISE LOCKS: SEE TECHNICAL INFORMATION FOR SOLID DOOR SECTION
MORTISE CYLINDERS NOT INCLUDED see page Levers_141 FOR COMPATIBLE MODELS

STANDARD FACEPLATE AND STRIKEPLATE SATIN STAINLESS STEEL.

SPINDLE DEPTH, LEVERS POSITION ON THE LOCKSET AND FIXING (SINGLE OR BACK TO BACK) MUST BE SPECIFIED ORDERING - see page Levers_143





ITEM

2MM.026.xxxx.xx











MATERIALS, FINISHING AND DETAILS

.XX = FINISH CODE

STAINLESS STEEL

- .44 SATIN STAINLESS STEEL (ANSI/BHMA 630 - USD32D)** 
- .43 BRIGHT STAINLESS STEEL (ANSI/BHMA 629 - USD32)** 

STAINLESS STEEL POWDER-COATED

- .40 BLACK RAL 9005 MATT - TO MATCH WITH PBA** 
- .26 BLACK ALUMINUM** 
- .31 WHITE RAL 9005 GLOSSY** 
- .32 GREY** 
- .38 CHAMPAGNE** 
- .39 BRONZE - TO MATCH WITH PBA BRONZE ALUMINUM** 
- .36 ARCHITECTURAL BRONZE** 
- .56 MEDIUM BRONZE** 
- .41 SILVER** 
- .55 GOLD** 
- .99 COLORS ON REQUEST TO MATCH ANY RAL #**
(screws, grub screws and plastic parts non powder-coated).
Available on request depending on quantities.

PVD ON SELECTED ITEMS

- .83 BLACK SATIN** 
Colors on demand, minimum lot to be agreed.
Screws and grub screws not pvd.

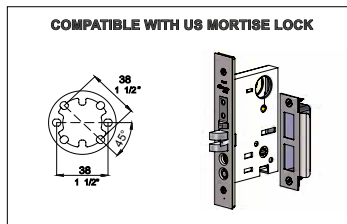
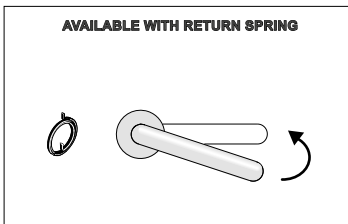

THESE PRODUCTS CONTRIBUTE TO **LEED®** CREDITS

THE MANUFACTURER RESERVES THE RIGHT TO ALTER, IMPROVE AND DISCONTINUE ANY FEATURES OF THE PRODUCT (MAKE CHANGES AND IMPROVEMENTS IN DESIGNS AND DIMENSIONS) WITHOUT NOTICE.

ALL DIMENSIONS IN THE CATALOG DRAWINGS ARE APPROXIMATIONS. REQUEST THE APPROPRIATE TECHNICAL DRAWING BEFORE DOOR PREPARATION AND INSTALLATION.

FIXING:

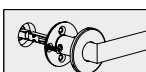

SINGLE SIDE FIXING

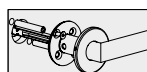

BACK TO BACK FIXING

HANDLE FOR MORTISE
WOOD OR HM DOORS



ITEM THESE PRODUCTS CONTRIBUTE TO LEED® CREDITS



2MM.026.0UT8 . xx

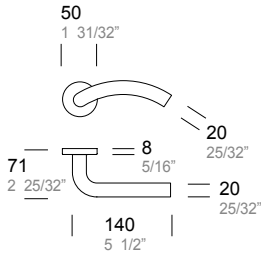

with return spring

2MM.026.00T4 . xx

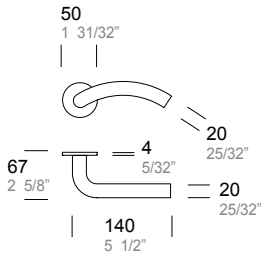

without return spring

2MM.026.0Uxx . xx

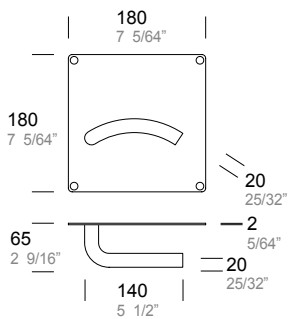

without return spring

2MM.026.0Uxx . xx

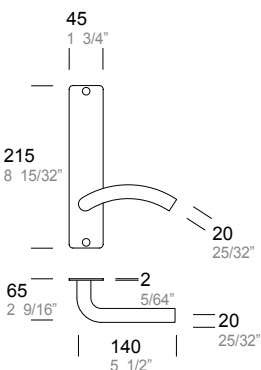

without return spring

LOCK
WOOD OR HM DOORS

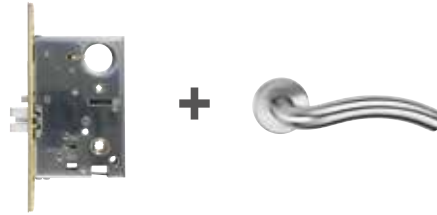

FUNCTION	BACKSET	HOW TO ORDER
PASSAGE ANSI F01	2 1/2" 2 3/4"	2MM.LCK.0A00 . xx + 2MM.026.0xTx . xx ONLY LOCK + 2MM.026.0Uxx . xx + 2MM.026.0Uxx . xx
OFFICE/CORRIDOR ANSI F04	2 1/2" 2 3/4"	2MM.LCK.0F00 . xx + 2MM.026.0xTx . xx ONLY LOCK + 2MM.026.0Uxx . xx + 2MM.026.0Uxx . xx
CLASSROOM ANSI F05	2 1/2" 2 3/4"	2MM.LCK.0G00 . xx + 2MM.026.0xTx . xx ONLY LOCK + 2MM.026.0Uxx . xx + 2MM.026.0Uxx . xx
STOREROOM ANSI F07	2 1/2" 2 3/4"	2MM.LCK.0P00 . xx + 2MM.026.0xTx . xx ONLY LOCK + 2MM.026.0Uxx . xx + 2MM.026.0Uxx . xx
OFFICE/ENTRY ANSI F04 + F13	2 1/2" 2 3/4"	2MM.LCK.0I00 . xx + 2MM.026.0xTx . xx ONLY LOCK + Add thumbturns page Levers_127 + 2MM.026.0Uxx . xx + Add thumbturns page Levers_127 + 2MM.026.0Uxx . xx + Add thumbturns page Levers_127
DORMITORY ANSI F13	2 1/2" 2 3/4"	2MM.LCK.0E00 . xx + 2MM.026.0xTx . xx ONLY LOCK + Add thumbturns page Levers_127 + 2MM.026.0Uxx . xx + Add thumbturns page Levers_127 + 2MM.026.0Uxx . xx + Add thumbturns page Levers_127
PRIVACY ANSI F19	2 1/2" 2 3/4"	2MM.LCK.0M00 . xx + 2MM.026.0xTx . xx ONLY LOCK + Add thumbturns page Levers_127 + 2MM.026.0Uxx . xx + Add thumbturns page Levers_127 + 2MM.026.0Uxx . xx + Add thumbturns page Levers_127

.XX = FINISH CODE

- STAINLESS STEEL
- .43 BRIGHT STAINLESS STEEL (ANSI/BHMA 629 - USD32)
- .44 SATIN STAINLESS STEEL (ANSI/BHMA 630 - USD32D)

PVD ON REQUEST

- .83 BLACK SATIN
- Colors on demand, minimum lot to be agreed.
- Screws and grub screws not pvd

STAINLESS STEEL POWDER-COATED ON REQUEST

- .40 BLACK RAL 9005 MATT - TO MATCH WITH PBA BLACK ALUMINUM
- .26 BLACK RAL 9005 GLOSSY
- .31 WHITE RAL 9010
- .32 GREY
- .38 CHAMPAGNE
- .39 BRONZE - TO MATCH WITH PBA BRONZE ALUMINUM
- .36 ARCHITECTURAL BRONZE
- .56 MEDIUM BRONZE
- .41 SILVER
- .55 GOLD

- .99 COLORS ON REQUEST TO MATCH ANY RAL #
(screws, grub screws and plastic parts non powder-coated)
available on request depending on quantities

MORTISE LOCKS: SEE TECHNICAL INFORMATION FOR SOLID DOOR SECTION

MORTISE CYLINDERS NOT INCLUDED see page Levers_141
FOR COMPATIBLE MODELS

STANDARD FACEPLATE AND STRIKEPLATE SATIN STAINLESS STEEL.

SPINDLE DEPTH, LEVERS POSITION ON THE LOCKSET AND FIXING
(SINGLE OR BACK TO BACK) MUST BE SPECIFIED ORDERING - see page Levers_143

HANDLE FOR MORTISE
GLASS DOORS WITH ALUMINUM PROFILE
OR WOOD AND HM DOORS

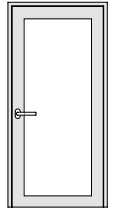

ITEM THESE PRODUCTS CONTRIBUTE TO **LEED®** CREDITS

2MM.026.0008 . xx

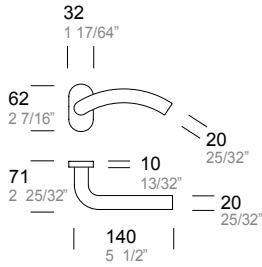

Ø with return spring

2MM.026.0004 . xx

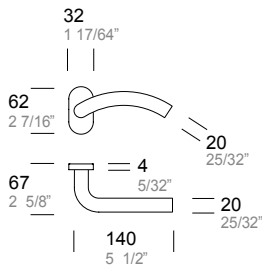

Ø without return spring

.XX = FINISH CODE

- STAINLESS STEEL**
.43 BRIGHT STAINLESS STEEL (ANSI/BHMA 629 - USD32)
.44 SATIN STAINLESS STEEL (ANSI/BHMA 630 - USD32D)

- PVD ON REQUEST**
.83 BLACK SATIN
Colors on demand, minimum lot to be agreed.
Screws and grub screws not pvd

STAINLESS STEEL POWDER-COATED ON REQUEST

- .40 BLACK RAL 9005 MATT - TO MATCH WITH PBA BLACK ALUMINUM
.26 BLACK RAL 9005 GLOSSY
.31 WHITE RAL 9010
.32 GREY
.38 CHAMPAGNE
.39 BRONZE - TO MATCH WITH PBA BRONZE ALUMINUM
.36 ARCHITECTURAL BRONZE
.56 MEDIUM BRONZE
.41 SILVER
.55 GOLD

- .99 COLORS ON REQUEST TO MATCH ANY RAL #
(screws, grub screws and plastic parts non powder-coated)
available on request depending on quantities

SPINDLE DEPTH, LEVERS POSITION ON THE LOCKSET AND FIXING
(SINGLE OR BACK TO BACK) MUST BE SPECIFIED ORDERING - see page Levers_143

HANDLE WITH LATCH
WOOD OR HM DOORS



ITEM BACKSET FUNCTION

2MM.026.SA70 . xx	70 mm 2 3/4"	PASSAGE	
2MM.026.SA60 . xx	60 mm 2 3/8"		
latch included			
with return spring			

2MM.026.SB70 . xx	70 mm 2 3/4"	PRIVACY	
2MM.026.SB60 . xx	60 mm 2 3/8"		
latch included			
with return spring			

2MM.026.MA70 . xx	70 mm 2 3/4"	PASSAGE WITH MAGNETIC BOLT	
2MM.026.MA60 . xx	60 mm 2 3/8"		
latch included			
with return spring			

2MM.026.MB70 . xx	70 mm 2 3/4"	PRIVACY WITH MAGNETIC BOLT	
2MM.026.MB60 . xx	60 mm 2 3/8"		
latch included			
with return spring			

HANDLE DUMMY
WOOD OR HM DOORS

THESE PRODUCTS CONTRIBUTE TO LEED® CREDITS



ITEM

2MM.026.0D06 . xx	SINGLE	
2MM.026.C0D6 . xx	PAIR	
dummy		
without return spring		

2MM.026.0D05 . xx	SINGLE	
2MM.026.C0D5 . xx	PAIR	
dummy		
without return spring		

.XX = FINISH CODE

- .43 STAINLESS STEEL
- .43 BRIGHT STAINLESS STEEL (ANSI/BHMA 629 - USD32)
- .44 SATIN STAINLESS STEEL (ANSI/BHMA 630 - USD32D)

PVD ON REQUEST

- .83 BLACK SATIN
- Colors on demand, minimum lot to be agreed.
- Screws and grub screws not pvd

- .40 STAINLESS STEEL POWDER-COATED ON REQUEST
- .26 BLACK RAL 9005 MATT- TO MATCH WITH PBA BLACK ALUMINUM
- .31 BLACK RAL 9005 GLOSSY
- .31 WHITE RAL 9010
- .32 GREY
- .38 CHAMPAGNE
- .39 BRONZE - TO MATCH WITH PBA BRONZE ALUMINUM
- .36 ARCHITECTURAL BRONZE
- .56 MEDIUM BRONZE
- .41 SILVER
- .55 GOLD

- .99 COLORS ON REQUEST TO MATCH ANY RAL #
- (screws, grub screws and plastic parts non powder-coated)
- available on request depending on quantities

LATCH DETAILS
page Levers_145



ITEM

2MM.027.xxxx.xx

MATERIALS, FINISHING AND DETAILS

.XX = FINISH CODE

STAINLESS STEEL

- .44 SATIN STAINLESS STEEL (ANSI/BHMA 630 - USD32D)**
- .43 BRIGHT STAINLESS STEEL (ANSI/BHMA 629 - USD32)**

STAINLESS STEEL POWDER-COATED

- .40 BLACK RAL 9005 MATT - TO MATCH WITH PBA**
- .26 BLACK ALUMINUM**
- .31 WHITE RAL 9005 GLOSSY**
- .32 GREY**
- .38 CHAMPAGNE**
- .39 BRONZE - TO MATCH WITH PBA BRONZE ALUMINUM**
- .36 ARCHITECTURAL BRONZE**
- .56 MEDIUM BRONZE**
- .41 SILVER**
- .55 GOLD**
- .99 COLORS ON REQUEST TO MATCH ANY RAL #**
(screws, grub screws and plastic parts non powder-coated).
Available on request depending on quantities.

PVD ON SELECTED ITEMS

- .83 BLACK SATIN**
Colors on demand, minimum lot to be agreed.
Screws and grub screws not pvd.

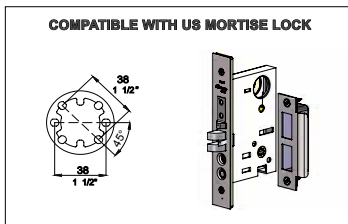
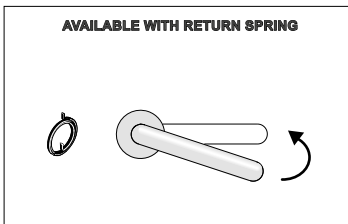

THESE PRODUCTS CONTRIBUTE TO **LEED®** CREDITS

THE MANUFACTURER RESERVES THE RIGHT TO ALTER, IMPROVE AND DISCONTINUE ANY FEATURES OF THE PRODUCT (MAKE CHANGES AND IMPROVEMENTS IN DESIGNS AND DIMENSIONS) WITHOUT NOTICE.

ALL DIMENSIONS IN THE CATALOG DRAWINGS ARE APPROXIMATIONS. REQUEST THE APPROPRIATE TECHNICAL DRAWING BEFORE DOOR PREPARATION AND INSTALLATION.

FIXING:

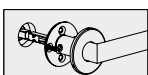

SINGLE SIDE FIXING

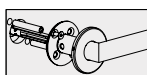

BACK TO BACK FIXING

HANDLE FOR MORTISE
WOOD OR HM DOORS



ITEM THESE PRODUCTS CONTRIBUTE TO LEED® CREDITS **Declare.**

2MM.027.0UT8 . xx

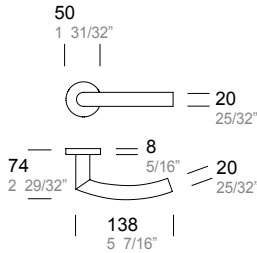

- mortise
- with return spring

2MM.027.00T4 . xx

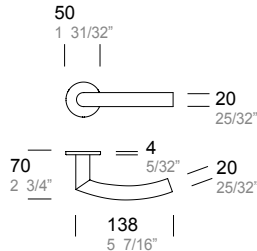

- mortise
- without return spring

2MM.027.0Uxx . xx

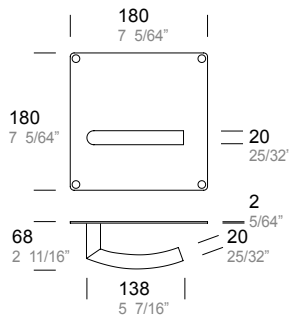

- mortise
- without return spring

2MM.027.0Uxx . xx

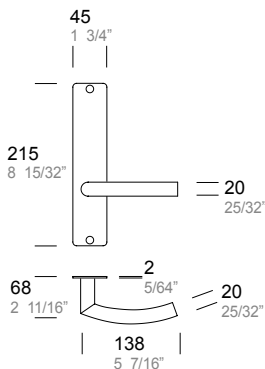

- mortise
- without return spring

LOCK
WOOD OR HM DOORS

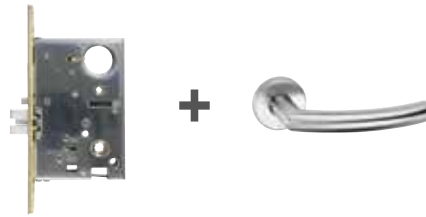

FUNCTION	BACKSET	HOW TO ORDER
PASSAGE ANSI F01 	2 1/2" 2 3/4"	2MM.LCK.0A00 . xx + ONLY LOCK
		+ 2MM.027.0Uxx . xx
		+ 2MM.027.0Uxx . xx
OFFICE/CORRIDOR ANSI F04 	2 1/2" 2 3/4"	2MM.LCK.0F00 . xx + ONLY LOCK
		+ 2MM.027.0Uxx . xx
		+ 2MM.027.0Uxx . xx
CLASSROOM ANSI F05 	2 1/2" 2 3/4"	2MM.LCK.0G00 . xx + ONLY LOCK
		+ 2MM.027.0Uxx . xx
		+ 2MM.027.0Uxx . xx
STOREROOM ANSI F07 	2 1/2" 2 3/4"	2MM.LCK.0P00 . xx + ONLY LOCK
		+ 2MM.027.0Uxx . xx
		+ 2MM.027.0Uxx . xx
OFFICE/ENTRY ANSI F04 + F13 	2 1/2" 2 3/4"	2MM.LCK.0I00 . xx + ONLY LOCK
		+ 2MM.027.0Uxx . xx ⊕ Add thumbturns page Levers_127
		+ 2MM.027.0Uxx . xx ⊕ Add thumbturns page Levers_127
		+ 2MM.027.0Uxx . xx ⊕ Add thumbturns page Levers_127
DORMITORY ANSI F13 	2 1/2" 2 3/4"	2MM.LCK.0E00 . xx + ONLY LOCK
		+ 2MM.027.0Uxx . xx ⊕ Add thumbturns page Levers_127
		+ 2MM.027.0Uxx . xx ⊕ Add thumbturns page Levers_127
		+ 2MM.027.0Uxx . xx ⊕ Add thumbturns page Levers_127
PRIVACY ANSI F19 	2 1/2" 2 3/4"	2MM.LCK.0M00 . xx + ONLY LOCK
		+ 2MM.027.0Uxx . xx ⊕ Add thumbturns page Levers_127
		+ 2MM.027.0Uxx . xx ⊕ Add thumbturns page Levers_127
		+ 2MM.027.0Uxx . xx ⊕ Add thumbturns page Levers_127

.XX = FINISH CODE

- STAINLESS STEEL**
- .43 BRIGHT STAINLESS STEEL (ANSI/BHMA 629 - USD32)
- .44 SATIN STAINLESS STEEL (ANSI/BHMA 630 - USD32D)

PVD ON REQUEST

- .83 BLACK SATIN
- Colors on demand, minimum lot to be agreed.
- Screws and grub screws not pvd

STAINLESS STEEL POWDER-COATED ON REQUEST

- .40 BLACK RAL 9005 MATT - TO MATCH WITH PBA BLACK ALUMINUM
- .26 BLACK RAL 9005 GLOSSY
- .31 WHITE RAL 9010
- .32 GREY
- .38 CHAMPAGNE
- .39 BRONZE - TO MATCH WITH PBA BRONZE ALUMINUM
- .36 ARCHITECTURAL BRONZE
- .56 MEDIUM BRONZE
- .41 SILVER
- .55 GOLD

- .99 COLORS ON REQUEST TO MATCH ANY RAL #
(screws, grub screws and plastic parts non powder-coated)
available on request depending on quantities

MORTISE LOCKS: SEE TECHNICAL INFORMATION FOR SOLID DOOR SECTION

MORTISE CYLINDERS NOT INCLUDED see page Levers_141 FOR COMPATIBLE MODELS

STANDARD FACEPLATE AND STRIKEPLATE SATIN STAINLESS STEEL.

SPINDLE DEPTH, LEVERS POSITION ON THE LOCKSET AND FIXING (SINGLE OR BACK TO BACK) MUST BE SPECIFIED ORDERING - see page Levers_143

HANDLE FOR MORTISE
GLASS DOORS WITH ALUMINUM PROFILE
OR WOOD AND HM DOORS

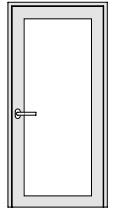

ITEM THESE PRODUCTS CONTRIBUTE TO **LEED®** CREDITS

2MM.027.0008 . xx

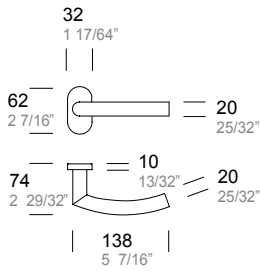

with return spring

2MM.027.0004 . xx

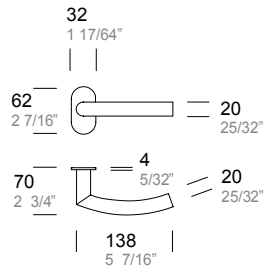

without return spring

.XX = FINISH CODE

- .43 BRIGHT STAINLESS STEEL (ANSI/BHMA 629 - USD32)
- .44 SATIN STAINLESS STEEL (ANSI/BHMA 630 - USD32D)

PVD ON REQUEST

- .83 BLACK SATIN
Colors on demand, minimum lot to be agreed.
Screws and grub screws not pvd

STAINLESS STEEL POWDER-COATED ON REQUEST

- .40 BLACK RAL 9005 MATT - TO MATCH WITH PBA BLACK ALUMINUM
- .26 BLACK RAL 9005 GLOSSY
- .31 WHITE RAL 9010
- .32 GREY
- .38 CHAMPAGNE
- .39 BRONZE - TO MATCH WITH PBA BRONZE ALUMINUM
- .36 ARCHITECTURAL BRONZE
- .56 MEDIUM BRONZE
- .41 SILVER
- .55 GOLD

- .99 COLORS ON REQUEST TO MATCH ANY RAL #
(screws, grub screws and plastic parts non powder-coated)
available on request depending on quantities

SPINDLE DEPTH, LEVERS POSITION ON THE LOCKSET AND FIXING
(SINGLE OR BACK TO BACK) MUST BE SPECIFIED ORDERING - see page Levers_143

HANDLE WITH LATCH
WOOD OR HM DOORS



ITEM BACKSET FUNCTION

2MM.027.SA70 . xx 70 mm PASSAGE
2 3/4"

2MM.027.SA60 . xx 60 mm
2 3/8"

latch included

with return spring

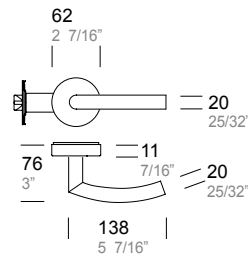

2MM.027.SB70 . xx 70 mm PRIVACY
2 3/4"

2MM.027.SB60 . xx 60 mm
2 3/8"

latch included

with return spring

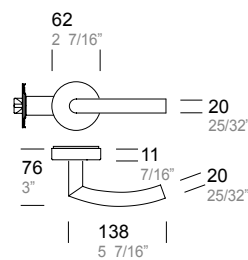

2MM.027.MA70 . xx 70 mm PASSAGE WITH
2 3/4" MAGNETIC BOLT

2MM.027.MA60 . xx 60 mm
2 3/8"

latch included

with return spring

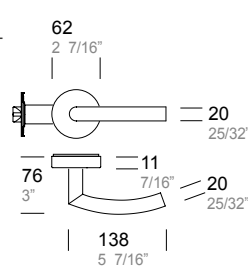

2MM.027.MB70 . xx 70 mm PRIVACY WITH
2 3/4" MAGNETIC BOLT

2MM.027.MB60 . xx 60 mm
2 3/8"

latch included

with return spring

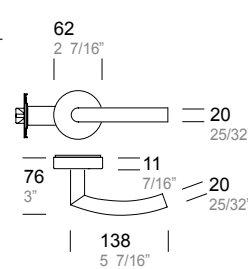

HANDLE DUMMY
WOOD OR HM DOORS

THESE PRODUCTS CONTRIBUTE TO LEED® CREDITS



ITEM

2MM.027.0D06 . xx SINGLE

2MM.027.C0D6 . xx PAIR

dummy

without return spring

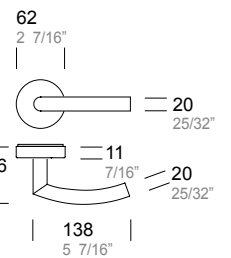

2MM.027.0D05 . xx SINGLE

2MM.027.C0D5 . xx PAIR

dummy

without return spring

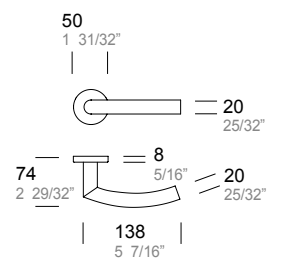

.XX = FINISH CODE

- STAINLESS STEEL
- .43 BRIGHT STAINLESS STEEL (ANSI/BHMA 629 - USD32)
- .44 SATIN STAINLESS STEEL (ANSI/BHMA 630 - USD32D)

PVD ON REQUEST

- .83 BLACK SATIN
- Colors on demand, minimum lot to be agreed.
- Screws and grub screws not pvd

- STAINLESS STEEL POWDER-COATED ON REQUEST
- .40 BLACK RAL 9005 MATT- TO MATCH WITH PBA BLACK ALUMINUM
- .26 BLACK RAL 9005 GLOSSY
- .31 WHITE RAL 9010
- .32 GREY
- .38 CHAMPAGNE
- .39 BRONZE - TO MATCH WITH PBA BRONZE ALUMINUM
- .36 ARCHITECTURAL BRONZE
- .56 MEDIUM BRONZE
- .41 SILVER
- .55 GOLD

- .99 COLORS ON REQUEST TO MATCH ANY RAL #
- (screws, grub screws and plastic parts non powder-coated)
- available on request depending on quantities

LATCH DETAILS
page Levers_145





ITEM

2MM.170.xxxx.xx











MATERIALS, FINISHING AND DETAILS

.XX = FINISH CODE

STAINLESS STEEL

- .44 SATIN STAINLESS STEEL (ANSI/BHMA 630 - USD32D)** 
- .43 BRIGHT STAINLESS STEEL (ANSI/BHMA 629 - USD32)** 

STAINLESS STEEL POWDER-COATED

- .40 BLACK RAL 9005 MATT - TO MATCH WITH PBA** 
- .26 BLACK ALUMINUM** 
- .31 WHITE RAL 9005 GLOSSY** 
- .32 GREY** 
- .38 CHAMPAGNE** 
- .39 BRONZE - TO MATCH WITH PBA BRONZE ALUMINUM** 
- .36 ARCHITECTURAL BRONZE** 
- .56 MEDIUM BRONZE** 
- .41 SILVER** 
- .55 GOLD** 
- .99 COLORS ON REQUEST TO MATCH ANY RAL #**
(screws, grub screws and plastic parts non powder-coated).
Available on request depending on quantities.

PVD ON SELECTED ITEMS

- .83 BLACK SATIN** 
Colors on demand, minimum lot to be agreed.
Screws and grub screws not pvd.

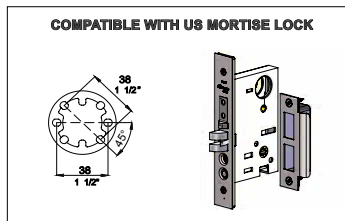

THESE PRODUCTS CONTRIBUTE TO **LEED®** CREDITS

THE MANUFACTURER RESERVES THE RIGHT TO ALTER, IMPROVE AND DISCONTINUE ANY FEATURES OF THE PRODUCT (MAKE CHANGES AND IMPROVEMENTS IN DESIGNS AND DIMENSIONS) WITHOUT NOTICE.

ALL DIMENSIONS IN THE CATALOG DRAWINGS ARE APPROXIMATIONS. REQUEST THE APPROPRIATE TECHNICAL DRAWING BEFORE DOOR PREPARATION AND INSTALLATION.

FIXING:

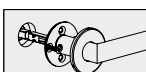

SINGLE SIDE FIXING

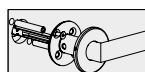

BACK TO BACK FIXING

HANDLE FOR MORTISE
WOOD OR HM DOORS



ITEM THESE PRODUCTS CONTRIBUTE TO LEED® CREDITS



2MM.170.0UT8 . xx

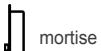
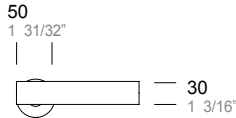

mortise

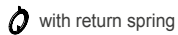

with return spring

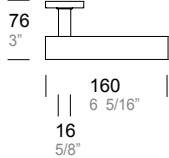

2MM.170.00T4 . xx

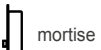
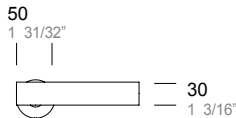

mortise

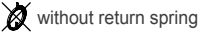

without return spring

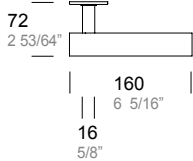

2MM.170.0Uxx . xx

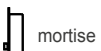
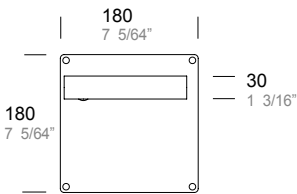

mortise

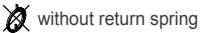

without return spring

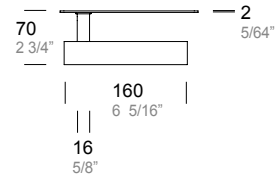

2MM.170.0Uxx . xx

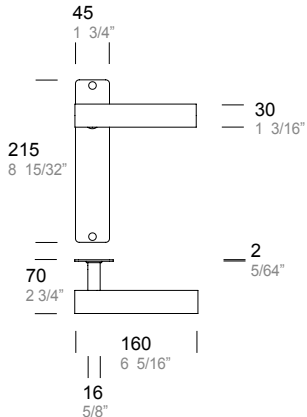

mortise

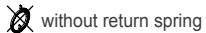

without return spring

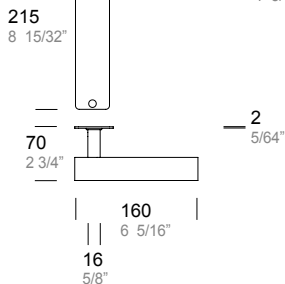

.XX = FINISH CODE

- STAINLESS STEEL
- .43 BRIGHT STAINLESS STEEL (ANSI/BHMA 629 - USD32)
- .44 SATIN STAINLESS STEEL (ANSI/BHMA 630 - USD32D)

PVD ON REQUEST

- .83 BLACK SATIN
- Colors on demand, minimum lot to be agreed.
- Screws and grub screws not pvd

STAINLESS STEEL POWDER-COATED ON REQUEST

- .40 BLACK RAL 9005 MATT - TO MATCH WITH PBA BLACK ALUMINUM
- .26 BLACK RAL 9005 GLOSSY
- .31 WHITE RAL 9010
- .32 GREY
- .38 CHAMPAGNE
- .39 BRONZE - TO MATCH WITH PBA BRONZE ALUMINUM
- .36 ARCHITECTURAL BRONZE
- .56 MEDIUM BRONZE
- .41 SILVER
- .55 GOLD

- .99 COLORS ON REQUEST TO MATCH ANY RAL # (screws, grub screws and plastic parts non powder-coated) available on request depending on quantities

MORTISE LOCKS: SEE TECHNICAL INFORMATION FOR SOLID DOOR SECTION

MORTISE CYLINDERS NOT INCLUDED see page Levers_141 FOR COMPATIBLE MODELS

STANDARD FACEPLATE AND STRIKEPLATE SATIN STAINLESS STEEL.

SPINDLE DEPTH, LEVERS POSITION ON THE LOCKSET AND FIXING (SINGLE OR BACK TO BACK) MUST BE SPECIFIED ORDERING - see page Levers_143

LOCK
WOOD OR HM DOORS

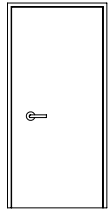

FUNCTION

BACKSET

HOW TO ORDER

PASSAGE
ANSI F01

2 1/2"
2 3/4"

2MM.LCK.0A00 . xx + ONLY LOCK

2MM.170.0xTx . xx

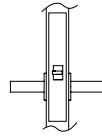

+ **2MM.170.0Uxx . xx**

+ **2MM.170.0Uxx . xx**

OFFICE/CORRIDOR
ANSI F04

2 1/2"
2 3/4"

2MM.LCK.0F00 . xx + ONLY LOCK

2MM.170.0xTx . xx

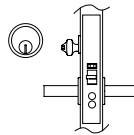

+ **2MM.170.0Uxx . xx**

+ **2MM.170.0Uxx . xx**

CLASSROOM
ANSI F05

2 1/2"
2 3/4"

2MM.LCK.0G00 . xx + ONLY LOCK

2MM.170.0xTx . xx

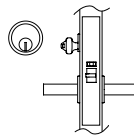

+ **2MM.170.0Uxx . xx**

+ **2MM.170.0Uxx . xx**

STOREROOM
ANSI F07

2 1/2"
2 3/4"

2MM.LCK.0P00 . xx + ONLY LOCK

2MM.170.0xTx . xx

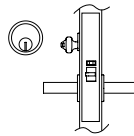

+ **2MM.170.0Uxx . xx**

+ **2MM.170.0Uxx . xx**

OFFICE/ENTRY
ANSI F04 + F13

2 1/2"
2 3/4"

2MM.LCK.0I00 . xx + ONLY LOCK

2MM.170.0xTx . xx

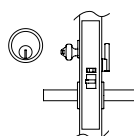

+ Add thumbturns page Levers_127 **2MM.170.0Uxx . xx**

+ Add thumbturns page Levers_127 **2MM.170.0Uxx . xx**

DORMITORY
ANSI F13

2 1/2"
2 3/4"

2MM.LCK.0E00 . xx + ONLY LOCK

2MM.170.0xTx . xx

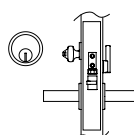

+ Add thumbturns page Levers_127 **2MM.170.0Uxx . xx**

+ Add thumbturns page Levers_127 **2MM.170.0Uxx . xx**

PRIVACY
ANSI F19

2 1/2"
2 3/4"

2MM.LCK.0M00 . xx + ONLY LOCK

2MM.170.0xTx . xx

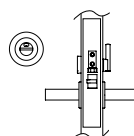

+ Add thumbturns page Levers_127 **2MM.170.0Uxx . xx**

+ Add thumbturns page Levers_127 **2MM.170.0Uxx . xx**

HANDLE FOR MORTISE
GLASS DOORS WITH ALUMINUM PROFILE
OR WOOD AND HM DOORS

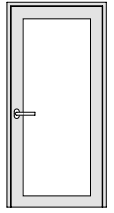

ITEM THESE PRODUCTS CONTRIBUTE TO LEED® CREDITS

2MM.170.0008 . xx

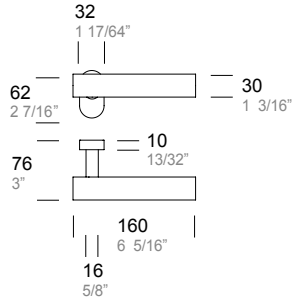

with return spring

2MM.170.0004 . xx

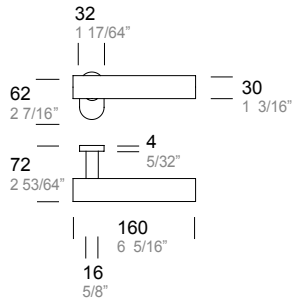

without return spring

.XX = FINISH CODE

- STAINLESS STEEL**
- .43 BRIGHT STAINLESS STEEL (ANSI/BHMA 629 - USD32)
- .44 SATIN STAINLESS STEEL (ANSI/BHMA 630 - USD32D)

PVD ON REQUEST

- .83 BLACK SATIN
- Colors on demand, minimum lot to be agreed.
- Screws and grub screws not pvd

STAINLESS STEEL POWDER-COATED ON REQUEST

- .40 BLACK RAL 9005 MATT - TO MATCH WITH PBA BLACK ALUMINUM
- .26 BLACK RAL 9005 GLOSSY
- .31 WHITE RAL 9010
- .32 GREY
- .38 CHAMPAGNE
- .39 BRONZE - TO MATCH WITH PBA BRONZE ALUMINUM
- .36 ARCHITECTURAL BRONZE
- .56 MEDIUM BRONZE
- .41 SILVER
- .55 GOLD

- .99 COLORS ON REQUEST TO MATCH ANY RAL #
- (screws, grub screws and plastic parts non powder-coated)
- available on request depending on quantities

SPINDLE DEPTH, LEVERS POSITION ON THE LOCKSET AND FIXING
(SINGLE OR BACK TO BACK) MUST BE SPECIFIED ORDERING - see page Levers_143

HANDLE WITH LATCH
WOOD OR HM DOORS



PLUS-DESIGN/ECOM



ITEM	BACKSET	FUNCTION	
2MM.170.SA70 . xx	70 mm 2 3/4"	PASSAGE	
2MM.170.SA60 . xx	60 mm 2 3/8"		
latch included			
with return spring			
2MM.170.SB70 . xx	70 mm 2 3/4"	PRIVACY	
2MM.170.SB60 . xx	60 mm 2 3/8"		
latch included			
with return spring			
2MM.170.MA70 . xx	70 mm 2 3/4"	PASSAGE WITH MAGNETIC BOLT	
2MM.170.MA60 . xx	60 mm 2 3/8"		
latch included			
with return spring			
2MM.170.MB70 . xx	70 mm 2 3/4"	PRIVACY WITH MAGNETIC BOLT	
2MM.170.MB60 . xx	60 mm 2 3/8"		
latch included			
with return spring			

HANDLE DUMMY
WOOD OR HM DOORS

THESE PRODUCTS CONTRIBUTE TO LEED® CREDITS



ITEM	BACKSET	FUNCTION	
2MM.170.0D06 . xx		SINGLE	
2MM.170.C0D6 . xx		PAIR	
dummy			
without return spring			
2MM.170.0D05 . xx		SINGLE	
2MM.170.C0D5 . xx		PAIR	
dummy			
without return spring			

.XX = FINISH CODE

- .43 STAINLESS STEEL
- .43 BRIGHT STAINLESS STEEL (ANSI/BHMA 629 - USD32)
- .44 SATIN STAINLESS STEEL (ANSI/BHMA 630 - USD32D)

PVD ON REQUEST

- .83 BLACK SATIN
- Colors on demand, minimum lot to be agreed.
- Screws and grub screws not pvd

STAINLESS STEEL POWDER-COATED ON REQUEST

- .40 BLACK RAL 9005 MATT. TO MATCH WITH PBA BLACK ALUMINUM
- .26 BLACK RAL 9005 GLOSSY
- .31 WHITE RAL 9010
- .32 GREY
- .38 CHAMPAGNE
- .39 BRONZE - TO MATCH WITH PBA BRONZE ALUMINUM
- .36 ARCHITECTURAL BRONZE
- .56 MEDIUM BRONZE
- .41 SILVER
- .55 GOLD

- .99 COLORS ON REQUEST TO MATCH ANY RAL #
- (screws, grub screws and plastic parts non powder-coated)
- available on request depending on quantities

LATCH DETAILS
page Levers_145





ITEM

0IT.151.xxxx.xx











MATERIALS, FINISHING AND DETAILS

.XX = FINISH CODE

STAINLESS STEEL

- .44 SATIN STAINLESS STEEL (ANSI/BHMA 630 - USD32D)** 
- .43 BRIGHT STAINLESS STEEL (ANSI/BHMA 629 - USD32)** 

STAINLESS STEEL POWDER-COATED

- .40 BLACK RAL 9005 MATT - TO MATCH WITH PBA** 
- .26 BLACK ALUMINUM** 
- .31 WHITE RAL 9005 GLOSSY** 
- .32 GREY** 
- .38 CHAMPAGNE** 
- .39 BRONZE - TO MATCH WITH PBA BRONZE ALUMINUM** 
- .36 ARCHITECTURAL BRONZE** 
- .56 MEDIUM BRONZE** 
- .41 SILVER** 
- .55 GOLD** 
- .99 COLORS ON REQUEST TO MATCH ANY RAL #**
(screws, grub screws and plastic parts non powder-coated).
Available on request depending on quantities.

PVD ON SELECTED ITEMS

- .83 BLACK SATIN** 
Colors on demand, minimum lot to be agreed.
Screws and grub screws not pvd.

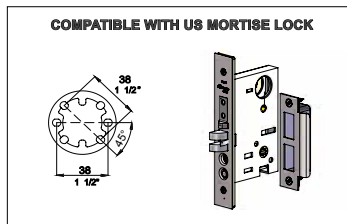
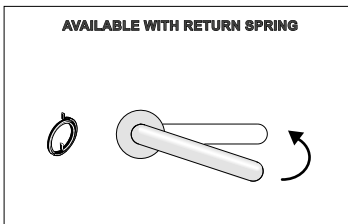

THESE PRODUCTS CONTRIBUTE TO **LEED®** CREDITS

THE MANUFACTURER RESERVES THE RIGHT TO ALTER, IMPROVE AND DISCONTINUE ANY FEATURES OF THE PRODUCT (MAKE CHANGES AND IMPROVEMENTS IN DESIGNS AND DIMENSIONS) WITHOUT NOTICE.

ALL DIMENSIONS IN THE CATALOG DRAWINGS ARE APPROXIMATIONS. REQUEST THE APPROPRIATE TECHNICAL DRAWING BEFORE DOOR PREPARATION AND INSTALLATION.

FIXING:

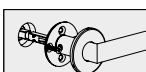

SINGLE SIDE FIXING

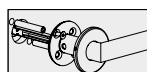

BACK TO BACK FIXING

HANDLE FOR MORTISE
WOOD OR HM DOORS



ITEM THESE PRODUCTS CONTRIBUTE TO LEED® CREDITS **Declare.**

● **0IT.151.0UT8 . xx**

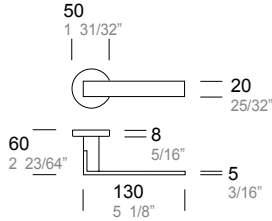

■ **0IT.151.0UQ8 . xx**

mortise

with return spring

0IT.151.00T4 . xx

mortise

without return spring

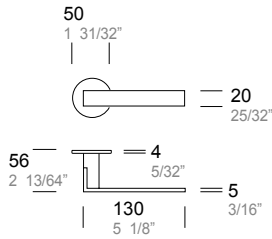

0IT.151.0Uxx . xx

mortise

without return spring

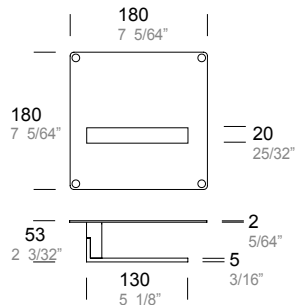

0IT.151.0Uxx . xx

mortise

without return spring

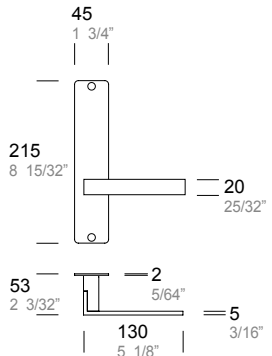

.XX = FINISH CODE

- STAINLESS STEEL**
 .43 BRIGHT STAINLESS STEEL (ANSI/BHMA 629 - USD32)
 .44 SATIN STAINLESS STEEL (ANSI/BHMA 630 - USD32D)

- PVD ON REQUEST**
 BLACK SATIN
 .83 Colors on demand, minimum lot to be agreed.
 Screws and grub screws not pvd

- STAINLESS STEEL POWDER-COATED ON REQUEST**
 .40 BLACK RAL 9005 MATT - TO MATCH WITH PBA BLACK ALUMINUM
 .26 BLACK RAL 9005 GLOSSY
 .31 WHITE RAL 9010
 .32 GREY
 .38 CHAMPAGNE
 .39 BRONZE - TO MATCH WITH PBA BRONZE ALUMINUM
 .36 ARCHITECTURAL BRONZE
 .56 MEDIUM BRONZE
 .41 SILVER
 .55 GOLD

- .99 COLORS ON REQUEST TO MATCH ANY RAL #**
 (screws, grub screws and plastic parts non powder-coated)
 available on request depending on quantities

MORTISE LOCKS: SEE TECHNICAL INFORMATION FOR SOLID DOOR SECTION
 MORTISE CYLINDERS NOT INCLUDED see page Levers_141
 FOR COMPATIBLE MODELS

STANDARD FACEPLATE AND STRIKEPLATE SATIN STAINLESS STEEL.

SPINDLE DEPTH, LEVERS POSITION ON THE LOCKSET AND FIXING
 (SINGLE OR BACK TO BACK) MUST BE SPECIFIED ORDERING - see page Levers_143

LOCK
WOOD OR HM DOORS

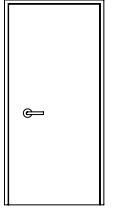

FUNCTION BACKSET HOW TO ORDER

PASSAGE ANSI F01 2 1/2" 2 3/4" **2MM.LCK.0A00 . xx** ONLY LOCK + **0IT.151.0xTx . xx**

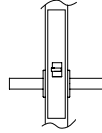

+ **0IT.151.0Uxx . xx**

+ **0IT.151.0Uxx . xx**

OFFICE/CORRIDOR ANSI F04 2 1/2" 2 3/4" **2MM.LCK.0F00 . xx** ONLY LOCK + **0IT.151.0xTx . xx**

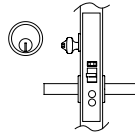

+ **0IT.151.0Uxx . xx**

+ **0IT.151.0Uxx . xx**

CLASSROOM ANSI F05 2 1/2" 2 3/4" **2MM.LCK.0G00 . xx** ONLY LOCK + **0IT.151.0xTx . xx**

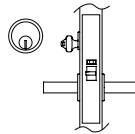

+ **0IT.151.0Uxx . xx**

+ **0IT.151.0Uxx . xx**

STOREROOM ANSI F07 2 1/2" 2 3/4" **2MM.LCK.0P00 . xx** ONLY LOCK + **0IT.151.0xTx . xx**

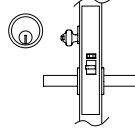

+ **0IT.151.0Uxx . xx**

+ **0IT.151.0Uxx . xx**

OFFICE/ENTRY ANSI F04 + F13 2 1/2" 2 3/4" **2MM.LCK.0I00 . xx** ONLY LOCK + **0IT.151.0xTx . xx**

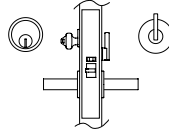

+ **0IT.151.0Uxx . xx**

+ **0IT.151.0Uxx . xx**

+ **0IT.151.0Uxx . xx**

+ **0IT.151.0Uxx . xx**

+ **0IT.151.0Uxx . xx**

+ **0IT.151.0Uxx . xx**

+ **0IT.151.0Uxx . xx**

+ **0IT.151.0Uxx . xx**

DORMITORY ANSI F13 2 1/2" 2 3/4" **2MM.LCK.0E00 . xx** ONLY LOCK + **0IT.151.0xTx . xx**

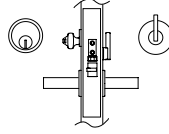

+ **0IT.151.0Uxx . xx**

+ **0IT.151.0Uxx . xx**

+ **0IT.151.0Uxx . xx**

+ **0IT.151.0Uxx . xx**

+ **0IT.151.0Uxx . xx**

PRIVACY ANSI F19 2 1/2" 2 3/4" **2MM.LCK.0M00 . xx** ONLY LOCK + **0IT.151.0xTx . xx**

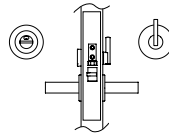

+ **0IT.151.0Uxx . xx**

+ **0IT.151.0Uxx . xx**

+ **0IT.151.0Uxx . xx**

+ **0IT.151.0Uxx . xx**

+ **0IT.151.0Uxx . xx**

HANDLE WITH LATCH
WOOD OR HM DOORS



ITEM BACKSET FUNCTION

0IT.151.SA70 . xx	70 mm 2 3/4"	PASSAGE	
0IT.151.SA60 . xx	60 mm 2 3/8"		

latch included

with return spring



0IT.151.SB70 . xx	70 mm 2 3/4"	PRIVACY	
0IT.151.SB60 . xx	60 mm 2 3/8"		

latch included

with return spring



0IT.151.MA70 . xx	70 mm 2 3/4"	PASSAGE WITH MAGNETIC BOLT	
0IT.151.MA60 . xx	60 mm 2 3/8"		

latch included

with return spring



0IT.151.MB70 . xx	70 mm 2 3/4"	PRIVACY WITH MAGNETIC BOLT	
0IT.151.MB60 . xx	60 mm 2 3/8"		

latch included

with return spring



HANDLE DUMMY
WOOD OR HM DOORS

THESE PRODUCTS CONTRIBUTE TO LEED® CREDITS



ITEM BACKSET FUNCTION

0IT.151.OD06 . xx	SINGLE	
0IT.151.C0D6 . xx	PAIR	

dummy

without return spring

0IT.151.OD05 . xx	SINGLE	
0IT.151.C0D5 . xx	PAIR	

dummy

without return spring

.XX = FINISH CODE

- STAINLESS STEEL
- .43 BRIGHT STAINLESS STEEL (ANSI/BHMA 629 - USD32)
- .44 SATIN STAINLESS STEEL (ANSI/BHMA 630 - USD32D)

PVD ON REQUEST

- .83 BLACK SATIN
- Colors on demand, minimum lot to be agreed.
- Screws and grub screws not pvd

STAINLESS STEEL POWDER-COATED ON REQUEST

- .40 BLACK RAL 9005 MATT - TO MATCH WITH PBA BLACK ALUMINUM
- .26 BLACK RAL 9005 GLOSSY
- .31 WHITE RAL 9010
- .32 GREY
- .38 CHAMPAGNE
- .39 BRONZE - TO MATCH WITH PBA BRONZE ALUMINUM
- .36 ARCHITECTURAL BRONZE
- .56 MEDIUM BRONZE
- .41 SILVER
- .55 GOLD

- .99 COLORS ON REQUEST TO MATCH ANY RAL #
- (screws, grub screws and plastic parts non powder-coated)
- available on request depending on quantities

LATCH DETAILS
page Levers_145





ITEM

0IT.152.xxxx.xx











MATERIALS, FINISHING AND DETAILS

.XX = FINISH CODE

STAINLESS STEEL

- .44 SATIN STAINLESS STEEL (ANSI/BHMA 630 - USD32D)** 
- .43 BRIGHT STAINLESS STEEL (ANSI/BHMA 629 - USD32)** 

STAINLESS STEEL POWDER-COATED

- .40 BLACK RAL 9005 MATT - TO MATCH WITH PBA** 
- .26 BLACK ALUMINUM** 
- .31 WHITE RAL 9005 GLOSSY** 
- .32 GREY** 
- .38 CHAMPAGNE** 
- .39 BRONZE - TO MATCH WITH PBA BRONZE ALUMINUM** 
- .36 ARCHITECTURAL BRONZE** 
- .56 MEDIUM BRONZE** 
- .41 SILVER** 
- .55 GOLD** 
- .99 COLORS ON REQUEST TO MATCH ANY RAL #**
(screws, grub screws and plastic parts non powder-coated).
Available on request depending on quantities.

PVD ON SELECTED ITEMS

- .83 BLACK SATIN** 
Colors on demand, minimum lot to be agreed.
Screws and grub screws not pvd.

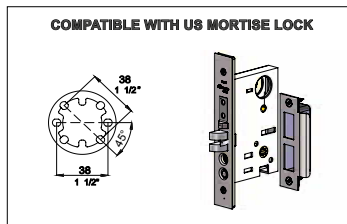
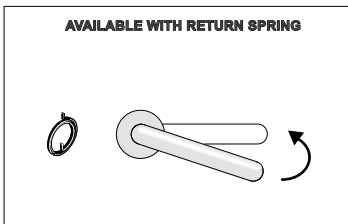

THESE PRODUCTS CONTRIBUTE TO **LEED®** CREDITS

THE MANUFACTURER RESERVES THE RIGHT TO ALTER, IMPROVE AND DISCONTINUE ANY FEATURES OF THE PRODUCT (MAKE CHANGES AND IMPROVEMENTS IN DESIGNS AND DIMENSIONS) WITHOUT NOTICE.

ALL DIMENSIONS IN THE CATALOG DRAWINGS ARE APPROXIMATIONS. REQUEST THE APPROPRIATE TECHNICAL DRAWING BEFORE DOOR PREPARATION AND INSTALLATION.

FIXING:

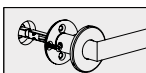

SINGLE SIDE FIXING

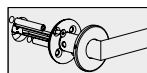

BACK TO BACK FIXING

HANDLE FOR MORTISE
WOOD OR HM DOORS



ITEM THESE PRODUCTS CONTRIBUTE TO LEED® CREDITS **Declare.**

● **0IT.152.0UT8 . xx**

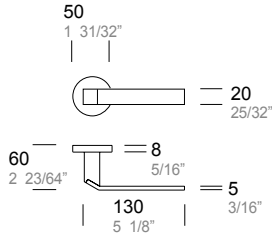

■ **0IT.152.0UQ8 . xx**



with return spring

0IT.152.00T4 . xx

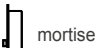

without return spring

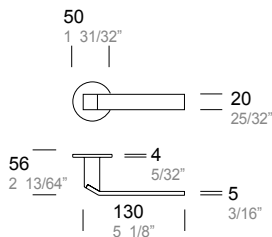

0IT.152.0Uxx . xx

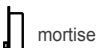

without return spring

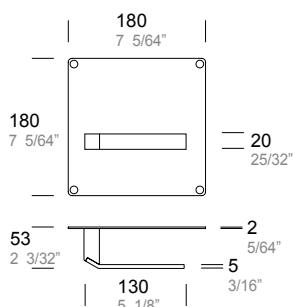

0IT.152.0Uxx . xx



without return spring

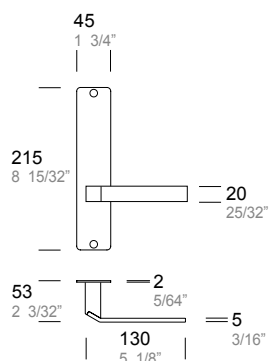

.XX = FINISH CODE

- STAINLESS STEEL**
- .43 BRIGHT STAINLESS STEEL (ANSI/BHMA 629 - USD32)
- .44 SATIN STAINLESS STEEL (ANSI/BHMA 630 - USD32D)

PVD ON REQUEST
BLACK SATIN

- .83 Colors on demand, minimum lot to be agreed.
- Screws and grub screws not pvd

- STAINLESS STEEL POWDER-COATED ON REQUEST**
- .40 BLACK RAL 9005 MATT - TO MATCH WITH PBA BLACK ALUMINUM
- .26 BLACK RAL 9005 GLOSSY
- .31 WHITE RAL 9010
- .32 GREY
- .38 CHAMPAGNE
- .39 BRONZE - TO MATCH WITH PBA BRONZE ALUMINUM
- .36 ARCHITECTURAL BRONZE
- .56 MEDIUM BRONZE
- .41 SILVER
- .55 GOLD

- .99 COLORS ON REQUEST TO MATCH ANY RAL # (screws, grub screws and plastic parts non powder-coated) available on request depending on quantities

MORTISE LOCKS: SEE TECHNICAL INFORMATION FOR SOLID DOOR SECTION
MORTISE CYLINDERS NOT INCLUDED see page Levers_141
FOR COMPATIBLE MODELS

STANDARD FACEPLATE AND STRIKEPLATE SATIN STAINLESS STEEL.

SPINDLE DEPTH, LEVERS POSITION ON THE LOCKSET AND FIXING (SINGLE OR BACK TO BACK) MUST BE SPECIFIED ORDERING - see page Levers_143

LOCK
WOOD OR HM DOORS

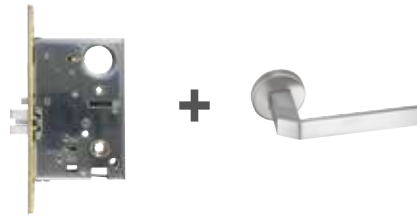

FUNCTION BACKSET HOW TO ORDER

PASSAGE ANSI F01 2 1/2" 2 3/4" **2MM.LCK.0A00 . xx** + **0IT.152.0xTx . xx**
ONLY LOCK + **0IT.152.0Uxx . xx**
+ **0IT.152.0Uxx . xx**

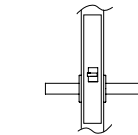

OFFICE/CORRIDOR ANSI F04 2 1/2" 2 3/4" **2MM.LCK.0F00 . xx** + **0IT.152.0xTx . xx**
ONLY LOCK + **0IT.152.0Uxx . xx**
+ **0IT.152.0Uxx . xx**

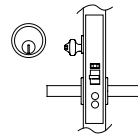

CLASSROOM ANSI F05 2 1/2" 2 3/4" **2MM.LCK.0G00 . xx** + **0IT.152.0xTx . xx**
ONLY LOCK + **0IT.152.0Uxx . xx**
+ **0IT.152.0Uxx . xx**

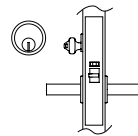

STOREROOM ANSI F07 2 1/2" 2 3/4" **2MM.LCK.0P00 . xx** + **0IT.152.0xTx . xx**
ONLY LOCK + **0IT.152.0Uxx . xx**
+ **0IT.152.0Uxx . xx**

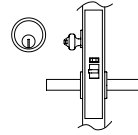

OFFICE/ENTRY ANSI F04 + F13 2 1/2" 2 3/4" **2MM.LCK.0I00 . xx** + **0IT.152.0xTx . xx**
ONLY LOCK + Add thumbturns page Levers_127 **0IT.152.0Uxx . xx**
+ Add thumbturns page Levers_127 **0IT.152.0Uxx . xx**
+ Add thumbturns page Levers_127 **0IT.152.0Uxx . xx**

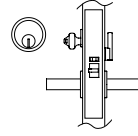

DORMITORY ANSI F13 2 1/2" 2 3/4" **2MM.LCK.0E00 . xx** + **0IT.152.0xTx . xx**
ONLY LOCK + Add thumbturns page Levers_127 **0IT.152.0Uxx . xx**
+ Add thumbturns page Levers_127 **0IT.152.0Uxx . xx**
+ Add thumbturns page Levers_127 **0IT.152.0Uxx . xx**

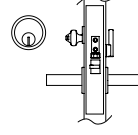

PRIVACY ANSI F19 2 1/2" 2 3/4" **2MM.LCK.0M00 . xx** + **0IT.152.0xTx . xx**
ONLY LOCK + Add thumbturns page Levers_127 **0IT.152.0Uxx . xx**
+ Add thumbturns page Levers_127 **0IT.152.0Uxx . xx**
+ Add thumbturns page Levers_127 **0IT.152.0Uxx . xx**

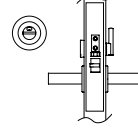

HANDLE WITH LATCH
WOOD OR HM DOORS



ITEM BACKSET FUNCTION

01T.152.SA70 . xx	70 mm 2 3/4"	PASSAGE	
01T.152.SA60 . xx	60 mm 2 3/8"		
	latch included		
	with return spring		



01T.152.SB70 . xx	70 mm 2 3/4"	PRIVACY	
01T.152.SB60 . xx	60 mm 2 3/8"		
	latch included		
	with return spring		



01T.152.MA70 . xx	70 mm 2 3/4"	PASSAGE WITH MAGNETIC BOLT	
01T.152.MA60 . xx	60 mm 2 3/8"		
	latch included		
	with return spring		



01T.152.MB70 . xx	70 mm 2 3/4"	PRIVACY WITH MAGNETIC BOLT	
01T.152.MB60 . xx	60 mm 2 3/8"		
	latch included		
	with return spring		



HANDLE DUMMY
WOOD OR HM DOORS

THESE PRODUCTS CONTRIBUTE TO LEED® CREDITS



ITEM BACKSET FUNCTION

01T.152.0D06 . xx	SINGLE	
01T.152.C0D6 . xx	PAIR	
	dummy	
	without return spring	

01T.152.0D05 . xx	SINGLE	
01T.152.C0D5 . xx	PAIR	
	dummy	
	without return spring	



.XX = FINISH CODE

- .43 STAINLESS STEEL
- .43 BRIGHT STAINLESS STEEL (ANSI/BHMA 629 - USD32)
- .44 SATIN STAINLESS STEEL (ANSI/BHMA 630 - USD32D)

PVD ON REQUEST

- .83 BLACK SATIN
- Colors on demand, minimum lot to be agreed.
- Screws and grub screws not pvd

STAINLESS STEEL POWDER-COATED ON REQUEST

- .40 BLACK RAL 9005 MATT- TO MATCH WITH PBA BLACK ALUMINUM
- .26 BLACK RAL 9005 GLOSSY
- .31 WHITE RAL 9010
- .32 GREY
- .38 CHAMPAGNE
- .39 BRONZE - TO MATCH WITH PBA BRONZE ALUMINUM
- .36 ARCHITECTURAL BRONZE
- .56 MEDIUM BRONZE
- .41 SILVER
- .55 GOLD

- .99 COLORS ON REQUEST TO MATCH ANY RAL #
- (screws, grub screws and plastic parts non powder-coated)
- available on request depending on quantities

LATCH DETAILS
page Levers_145



ITEM

0IT.153.xxxx.xx

MATERIALS, FINISHING AND DETAILS

.XX = FINISH CODE

STAINLESS STEEL

- .44 SATIN STAINLESS STEEL (ANSI/BHMA 630 - USD32D)**
- .43 BRIGHT STAINLESS STEEL (ANSI/BHMA 629 - USD32)**

STAINLESS STEEL POWDER-COATED

- .40 BLACK RAL 9005 MATT - TO MATCH WITH PBA**
- .26 BLACK ALUMINUM**
- .31 WHITE RAL 9005 GLOSSY**
- .32 GREY**
- .38 CHAMPAGNE**
- .39 BRONZE - TO MATCH WITH PBA BRONZE ALUMINUM**
- .36 ARCHITECTURAL BRONZE**
- .56 MEDIUM BRONZE**
- .41 SILVER**
- .55 GOLD**
- .99 COLORS ON REQUEST TO MATCH ANY RAL #**
(screws, grub screws and plastic parts non powder-coated).
Available on request depending on quantities.

PVD ON SELECTED ITEMS

- .83 BLACK SATIN**
Colors on demand, minimum lot to be agreed.
Screws and grub screws not pvd.

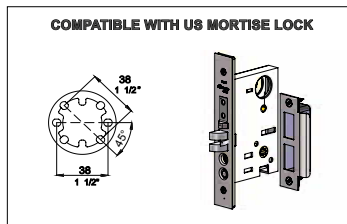
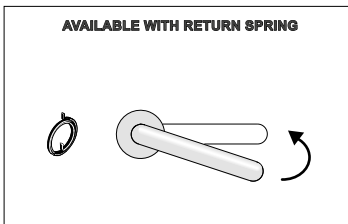

THESE PRODUCTS CONTRIBUTE TO **LEED®** CREDITS

THE MANUFACTURER RESERVES THE RIGHT TO ALTER, IMPROVE AND DISCONTINUE ANY FEATURES OF THE PRODUCT (MAKE CHANGES AND IMPROVEMENTS IN DESIGNS AND DIMENSIONS) WITHOUT NOTICE.

ALL DIMENSIONS IN THE CATALOG DRAWINGS ARE APPROXIMATIONS. REQUEST THE APPROPRIATE TECHNICAL DRAWING BEFORE DOOR PREPARATION AND INSTALLATION.

FIXING:

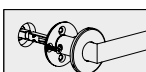

SINGLE SIDE FIXING

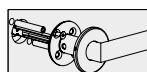

BACK TO BACK FIXING

HANDLE FOR MORTISE
WOOD OR HM DOORS



ITEM THESE PRODUCTS CONTRIBUTE TO LEED® CREDITS **Declare.**

● 0IT.153.0UT8 . xx

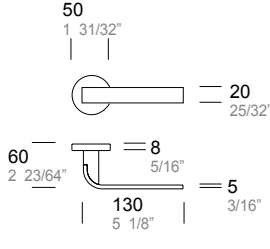

■ 0IT.153.0UQ8 . xx

mortise

with return spring

0IT.153.00T4 . xx

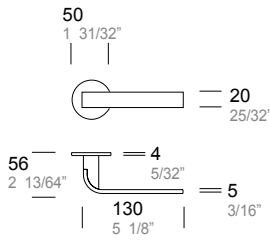

mortise

without return spring

0IT.153.0Uxx . xx

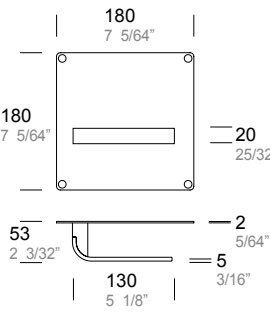

mortise

without return spring

0IT.153.0Uxx . xx

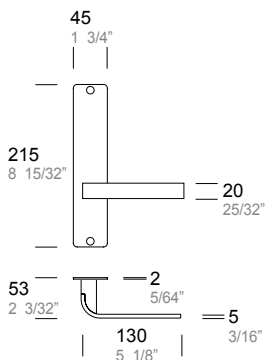

mortise

without return spring

.XX = FINISH CODE

- STAINLESS STEEL
- .43 BRIGHT STAINLESS STEEL (ANSI/BHMA 629 - USD32)
- .44 SATIN STAINLESS STEEL (ANSI/BHMA 630 - USD32D)

PVD ON REQUEST

- BLACK SATIN
- .83 Colors on demand, minimum lot to be agreed.

Screws and grub screws not pvd

- STAINLESS STEEL POWDER-COATED ON REQUEST
- .40 BLACK RAL 9005 MATT - TO MATCH WITH PBA BLACK ALUMINUM
- .26 BLACK RAL 9005 GLOSSY
- .31 WHITE RAL 9010
- .32 GREY
- .38 CHAMPAGNE
- .39 BRONZE - TO MATCH WITH PBA BRONZE ALUMINUM
- .36 ARCHITECTURAL BRONZE
- .56 MEDIUM BRONZE
- .41 SILVER
- .55 GOLD

- .99 COLORS ON REQUEST TO MATCH ANY RAL # (screws, grub screws and plastic parts non powder-coated) available on request depending on quantities

MORTISE LOCKS: SEE TECHNICAL INFORMATION FOR SOLID DOOR SECTION
MORTISE CYLINDERS NOT INCLUDED see page Levers_141
FOR COMPATIBLE MODELS

STANDARD FACEPLATE AND STRIKEPLATE SATIN STAINLESS STEEL.

SPINDLE DEPTH, LEVERS POSITION ON THE LOCKSET AND FIXING (SINGLE OR BACK TO BACK) MUST BE SPECIFIED ORDERING - see page Levers_143

LOCK
WOOD OR HM DOORS

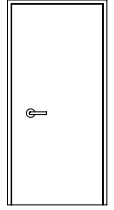
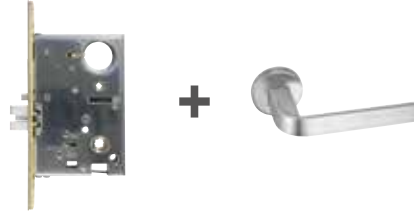

FUNCTION BACKSET HOW TO ORDER

 PASSAGE ANSI F01	2 1/2"	 2MM.LCK.0A00 . xx ONLY LOCK	+	0IT.153.0xTx . xx	
	2 3/4"			+	0IT.153.0Uxx . xx
				+	0IT.153.0Uxx . xx

 OFFICE/CORRIDOR ANSI F04	2 1/2"	 2MM.LCK.0F00 . xx ONLY LOCK	+	0IT.153.0xTx . xx	
	2 3/4"			+	0IT.153.0Uxx . xx
				+	0IT.153.0Uxx . xx

 CLASSROOM ANSI F05	2 1/2"	 2MM.LCK.0G00 . xx ONLY LOCK	+	0IT.153.0xTx . xx	
	2 3/4"			+	0IT.153.0Uxx . xx
				+	0IT.153.0Uxx . xx

 STOREROOM ANSI F07	2 1/2"	 2MM.LCK.0P00 . xx ONLY LOCK	+	0IT.153.0xTx . xx	
	2 3/4"			+	0IT.153.0Uxx . xx
				+	0IT.153.0Uxx . xx

 OFFICE/ENTRY ANSI F04 + F13	2 1/2"	 2MM.LCK.0I00 . xx ONLY LOCK	+	0IT.153.0xTx . xx	
	2 3/4"			+	0IT.153.0Uxx . xx
				+	0IT.153.0Uxx . xx

 DORMITORY ANSI F13	2 1/2"	 2MM.LCK.0E00 . xx ONLY LOCK	+	0IT.153.0xTx . xx	
	2 3/4"			+	0IT.153.0Uxx . xx
				+	0IT.153.0Uxx . xx

 PRIVACY ANSI F19	2 1/2"	 2MM.LCK.0M00 . xx ONLY LOCK	+	0IT.153.0xTx . xx	
	2 3/4"			+	0IT.153.0Uxx . xx
				+	0IT.153.0Uxx . xx

HANDLE WITH LATCH
WOOD OR HM DOORS



ITEM BACKSET FUNCTION

01T.153.SA70 . xx	70 mm 2 3/4"	PASSAGE	
01T.153.SA60 . xx	60 mm 2 3/8"		
	latch included		
	with return spring		



01T.153.SB70 . xx	70 mm 2 3/4"	PRIVACY	
01T.153.SB60 . xx	60 mm 2 3/8"		
	latch included		
	with return spring		



01T.153.MA70 . xx	70 mm 2 3/4"	PASSAGE WITH MAGNETIC BOLT	
01T.153.MA60 . xx	60 mm 2 3/8"		
	latch included		
	with return spring		



01T.153.MB70 . xx	70 mm 2 3/4"	PRIVACY WITH MAGNETIC BOLT	
01T.153.MB60 . xx	60 mm 2 3/8"		
	latch included		
	with return spring		



HANDLE DUMMY THESE PRODUCTS CONTRIBUTE TO LEED® CREDITS
WOOD OR HM DOORS



ITEM

01T.153.0D06 . xx	SINGLE	
01T.153.C0D6 . xx	PAIR	
	dummy	
	without return spring	

01T.153.0D05 . xx	SINGLE	
01T.153.C0D5 . xx	PAIR	
	dummy	
	without return spring	

.XX = FINISH CODE

- .43 STAINLESS STEEL
- .43 BRIGHT STAINLESS STEEL (ANSI/BHMA 629 - USD32)
- .44 SATIN STAINLESS STEEL (ANSI/BHMA 630 - USD32D)

PVD ON REQUEST

- .83 BLACK SATIN
- Colors on demand, minimum lot to be agreed.
- Screws and grub screws not pvd

STAINLESS STEEL POWDER-COATED ON REQUEST

- .40 BLACK RAL 9005 MATT - TO MATCH WITH PBA BLACK ALUMINUM
- .26 BLACK RAL 9005 GLOSSY
- .31 WHITE RAL 9010
- .32 GREY
- .38 CHAMPAGNE
- .39 BRONZE - TO MATCH WITH PBA BRONZE ALUMINUM
- .36 ARCHITECTURAL BRONZE
- .56 MEDIUM BRONZE
- .41 SILVER
- .55 GOLD

- .99 COLORS ON REQUEST TO MATCH ANY RAL #
- (screws, grub screws and plastic parts non powder-coated)
- available on request depending on quantities

LATCH DETAILS
page Levers_145





ITEM

2MM.020.xxxx.xx











MATERIALS, FINISHING AND DETAILS

.XX = FINISH CODE

STAINLESS STEEL

- .44 SATIN STAINLESS STEEL (ANSI/BHMA 630 - USD32D) 
- .43 BRIGHT STAINLESS STEEL (ANSI/BHMA 629 - USD32) 

STAINLESS STEEL POWDER-COATED

- .40 BLACK RAL 9005 MATT - TO MATCH WITH PBA 
- .26 BLACK ALUMINUM 
- .31 WHITE RAL 9005 GLOSSY 
- .32 GREY 
- .38 CHAMPAGNE 
- .39 BRONZE - TO MATCH WITH PBA BRONZE ALUMINUM 
- .36 ARCHITECTURAL BRONZE 
- .56 MEDIUM BRONZE 
- .41 SILVER 
- .55 GOLD 
- .99 COLORS ON REQUEST TO MATCH ANY RAL #
(screws, grub screws and plastic parts non powder-coated).
Available on request depending on quantities.

PVD ON SELECTED ITEMS

- .83 BLACK SATIN 
Colors on demand, minimum lot to be agreed.
Screws and grub screws not pvd.

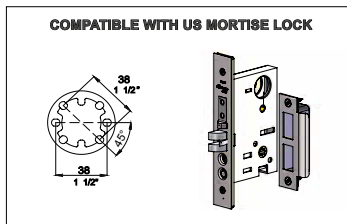

THESE PRODUCTS CONTRIBUTE TO LEED® CREDITS

THE MANUFACTURER RESERVES THE RIGHT TO ALTER, IMPROVE AND DISCONTINUE ANY FEATURES OF THE PRODUCT (MAKE CHANGES AND IMPROVEMENTS IN DESIGNS AND DIMENSIONS) WITHOUT NOTICE.

ALL DIMENSIONS IN THE CATALOG DRAWINGS ARE APPROXIMATIONS. REQUEST THE APPROPRIATE TECHNICAL DRAWING BEFORE DOOR PREPARATION AND INSTALLATION.

FIXING:

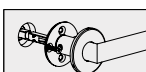

SINGLE SIDE FIXING

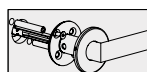

BACK TO BACK FIXING

HANDLE FOR MORTISE
WOOD OR HM DOORS



ITEM THESE PRODUCTS CONTRIBUTE TO LEED® CREDITS **Declare.**

2MM.020.0UT8 . xx



with return spring

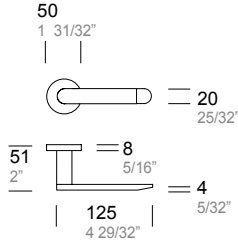

2MM.020.00T4 . xx



without return spring

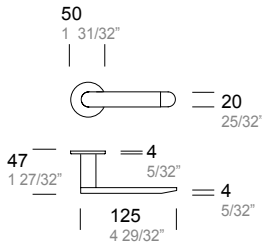

2MM.020.0Uxx . xx



without return spring

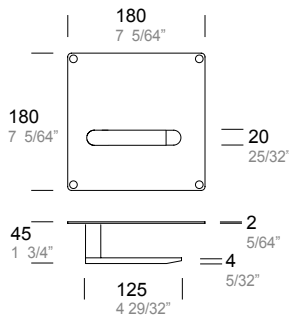

2MM.020.0Uxx . xx



without return spring

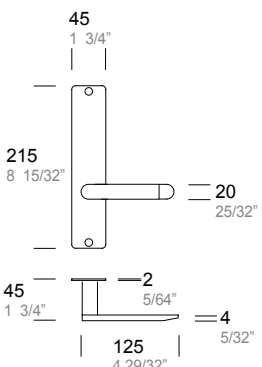

LOCK
WOOD OR HM DOORS

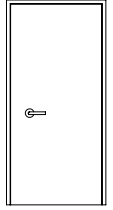
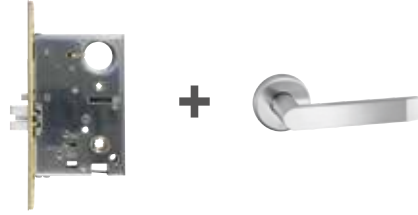

FUNCTION	BACKSET	HOW TO ORDER
PASSAGE ANSI F01	2 1/2" 2 3/4"	2MM.LCK.0A00 . xx + 2MM.020.0xTx . xx ONLY LOCK + 2MM.020.0Uxx . xx + 2MM.020.0Uxx . xx
OFFICE/CORRIDOR ANSI F04	2 1/2" 2 3/4"	2MM.LCK.0F00 . xx + 2MM.020.0xTx . xx ONLY LOCK + 2MM.020.0Uxx . xx + 2MM.020.0Uxx . xx
CLASSROOM ANSI F05	2 1/2" 2 3/4"	2MM.LCK.0G00 . xx + 2MM.020.0xTx . xx ONLY LOCK + 2MM.020.0Uxx . xx + 2MM.020.0Uxx . xx
STOREROOM ANSI F07	2 1/2" 2 3/4"	2MM.LCK.0P00 . xx + 2MM.020.0xTx . xx ONLY LOCK + 2MM.020.0Uxx . xx + 2MM.020.0Uxx . xx
OFFICE/ENTRY ANSI F04 + F13	2 1/2" 2 3/4"	2MM.LCK.0I00 . xx + 2MM.020.0xTx . xx ONLY LOCK + Add thumbturns page Levers_127 2MM.020.0Uxx . xx + Add thumbturns page Levers_127 2MM.020.0Uxx . xx + Add thumbturns page Levers_127 2MM.020.0Uxx . xx
DORMITORY ANSI F13	2 1/2" 2 3/4"	2MM.LCK.0E00 . xx + 2MM.020.0xTx . xx ONLY LOCK + Add thumbturns page Levers_127 2MM.020.0Uxx . xx + Add thumbturns page Levers_127 2MM.020.0Uxx . xx + Add thumbturns page Levers_127 2MM.020.0Uxx . xx
PRIVACY ANSI F19	2 1/2" 2 3/4"	2MM.LCK.0M00 . xx + 2MM.020.0xTx . xx ONLY LOCK + Add thumbturns page Levers_127 2MM.020.0Uxx . xx + Add thumbturns page Levers_127 2MM.020.0Uxx . xx + Add thumbturns page Levers_127 2MM.020.0Uxx . xx

.XX = FINISH CODE

- STAINLESS STEEL
- .43 BRIGHT STAINLESS STEEL (ANSI/BHMA 629 - USD32)
- .44 SATIN STAINLESS STEEL (ANSI/BHMA 630 - USD32D)
- PVD ON REQUEST
- .83 BLACK SATIN
- Colors on demand, minimum lot to be agreed.
- Screws and grub screws not pvd

- STAINLESS STEEL POWDER-COATED ON REQUEST
- .40 BLACK RAL 9005 MATT - TO MATCH WITH PBA BLACK ALUMINUM
- .26 BLACK RAL 9005 GLOSSY
- .31 WHITE RAL 9010
- .32 GREY
- .38 CHAMPAGNE
- .39 BRONZE - TO MATCH WITH PBA BRONZE ALUMINUM
- .36 ARCHITECTURAL BRONZE
- .56 MEDIUM BRONZE
- .41 SILVER
- .55 GOLD

.99 COLORS ON REQUEST TO MATCH ANY RAL #
(screws, grub screws and plastic parts non powder-coated)
available on request depending on quantities

MORTISE LOCKS: SEE TECHNICAL INFORMATION FOR SOLID DOOR SECTION
MORTISE CYLINDERS NOT INCLUDED see page Levers_141
FOR COMPATIBLE MODELS

STANDARD FACEPLATE AND STRIKEPLATE SATIN STAINLESS STEEL.

SPINDLE DEPTH, LEVERS POSITION ON THE LOCKSET AND FIXING
(SINGLE OR BACK TO BACK) MUST BE SPECIFIED ORDERING - see page Levers_143

HANDLE FOR MORTISE

GLASS DOORS WITH ALUMINUM PROFILE
OR WOOD AND HM DOORS

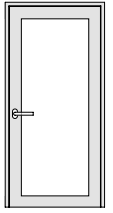

ITEM THESE PRODUCTS CONTRIBUTE TO **LEED®** CREDITS



2MM.020.0008 . xx

32
1 17/64"

62 20
2 7/16" 25/32"

with return spring

62 10 4
2 7/16" 13/32" 5/32"
125 4 29/32"

2MM.020.0004 . xx

32
1 17/64"

62 20
2 7/16" 25/32"

without return spring

57 4 4
2 1/4" 5/32" 5/32"
125 4 29/32"

.XX = FINISH CODE

STAINLESS STEEL

- .43 BRIGHT STAINLESS STEEL (ANSI/BHMA 629 - USD32)
- .44 SATIN STAINLESS STEEL (ANSI/BHMA 630 - USD32D)

PVD ON REQUEST

- .83 BLACK SATIN
Colors on demand, minimum lot to be agreed.
Screws and grub screws not pvd

STAINLESS STEEL POWDER-COATED ON REQUEST

- .40 BLACK RAL 9005 MATT - TO MATCH WITH PBA BLACK ALUMINUM
- .26 BLACK RAL 9005 GLOSSY
- .31 WHITE RAL 9010
- .32 GREY
- .38 CHAMPAGNE
- .39 BRONZE - TO MATCH WITH PBA BRONZE ALUMINUM
- .36 ARCHITECTURAL BRONZE
- .56 MEDIUM BRONZE
- .41 SILVER
- .55 GOLD

- .99 COLORS ON REQUEST TO MATCH ANY RAL #
(screws, grub screws and plastic parts non powder-coated)
available on request depending on quantities

SPINDLE DEPTH, LEVERS POSITION ON THE LOCKSET AND FIXING
(SINGLE OR BACK TO BACK) MUST BE SPECIFIED ORDERING - see page Levers_143

HANDLE WITH LATCH
WOOD OR HM DOORS



ITEM	BACKSET	FUNCTION	
2MM.020.SA70 . xx	70 mm 2 3/4"	PASSAGE	
2MM.020.SA60 . xx	60 mm 2 3/8"		
latch included			
with return spring			
2MM.020.SB70 . xx	70 mm 2 3/4"	PRIVACY	
2MM.020.SB60 . xx	60 mm 2 3/8"		
latch included			
with return spring			
2MM.020.MA70 . xx	70 mm 2 3/4"	PASSAGE WITH MAGNETIC BOLT	
2MM.020.MA60 . xx	60 mm 2 3/8"		
latch included			
with return spring			
2MM.020.MB70 . xx	70 mm 2 3/4"	PRIVACY WITH MAGNETIC BOLT	
2MM.020.MB60 . xx	60 mm 2 3/8"		
latch included			
with return spring			

HANDLE DUMMY
WOOD OR HM DOORS

THESE PRODUCTS CONTRIBUTE TO LEED® CREDITS



ITEM	BACKSET	FUNCTION	
2MM.020.0D06 . xx		SINGLE	
2MM.020.C0D6 . xx		PAIR	
dummy			
without return spring			
2MM.020.0D05 . xx		SINGLE	
2MM.020.C0D5 . xx		PAIR	
dummy			
without return spring			

.XX = FINISH CODE

- .43 STAINLESS STEEL
- .43 BRIGHT STAINLESS STEEL (ANSI/BHMA 629 - USD32)
- .44 SATIN STAINLESS STEEL (ANSI/BHMA 630 - USD32D)

PVD ON REQUEST

- .83 BLACK SATIN
- Colors on demand, minimum lot to be agreed.
- Screws and grub screws not pvd

STAINLESS STEEL POWDER-COATED ON REQUEST

- .40 BLACK RAL 9005 MATT - TO MATCH WITH PBA BLACK ALUMINUM
- .26 BLACK RAL 9005 GLOSSY
- .31 WHITE RAL 9010
- .32 GREY
- .38 CHAMPAGNE
- .39 BRONZE - TO MATCH WITH PBA BRONZE ALUMINUM
- .36 ARCHITECTURAL BRONZE
- .56 MEDIUM BRONZE
- .41 SILVER
- .55 GOLD

- .99 COLORS ON REQUEST TO MATCH ANY RAL # (screws, grub screws and plastic parts non powder-coated) available on request depending on quantities

LATCH DETAILS
page Levers_145

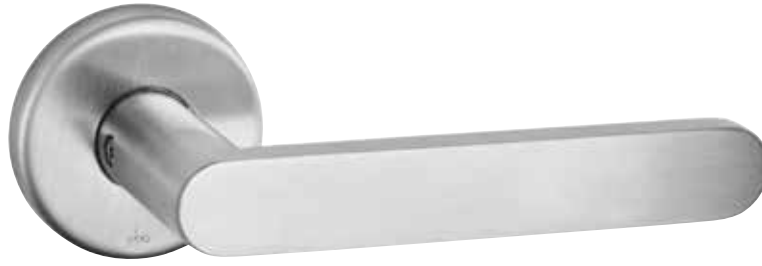

ITEM

2MM.20S.xxxx.xx

MATERIALS, FINISHING AND DETAILS

.XX = FINISH CODE

STAINLESS STEEL

- .44 SATIN STAINLESS STEEL (ANSI/BHMA 630 - USD32D)**
- .43 BRIGHT STAINLESS STEEL (ANSI/BHMA 629 - USD32)**



STAINLESS STEEL POWDER-COATED

- .40 BLACK RAL 9005 MATT - TO MATCH WITH PBA**
- .26 BLACK ALUMINUM**
- .31 WHITE RAL 9005 GLOSSY**
- .32 GREY**
- .38 CHAMPAGNE**
- .39 BRONZE - TO MATCH WITH PBA BRONZE ALUMINUM**
- .36 ARCHITECTURAL BRONZE**
- .56 MEDIUM BRONZE**
- .41 SILVER**
- .55 GOLD**
- .99 COLORS ON REQUEST TO MATCH ANY RAL #**
(screws, grub screws and plastic parts non powder-coated).
Available on request depending on quantities.



PVD ON SELECTED ITEMS

- .83 BLACK SATIN**
Colors on demand, minimum lot to be agreed.
Screws and grub screws not pvd.

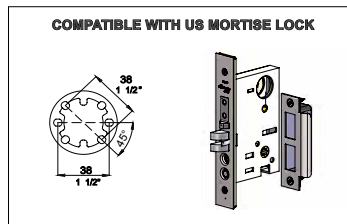

THESE PRODUCTS CONTRIBUTE TO **LEED®** CREDITS

THE MANUFACTURER RESERVES THE RIGHT TO ALTER, IMPROVE AND DISCONTINUE ANY FEATURES OF THE PRODUCT (MAKE CHANGES AND IMPROVEMENTS IN DESIGNS AND DIMENSIONS) WITHOUT NOTICE.

ALL DIMENSIONS IN THE CATALOG DRAWINGS ARE APPROXIMATIONS. REQUEST THE APPROPRIATE TECHNICAL DRAWING BEFORE DOOR PREPARATION AND INSTALLATION.

FIXING:

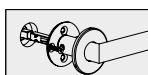

SINGLE SIDE FIXING

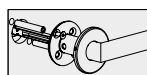

BACK TO BACK FIXING

HANDLE FOR MORTISE
WOOD OR HM DOORS



ITEM THESE PRODUCTS CONTRIBUTE TO LEED® CREDITS

2MM.20S.0UT8 . xx

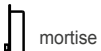

with return spring

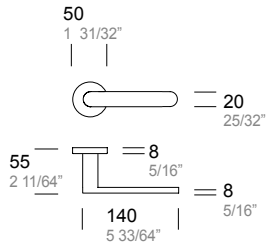

2MM.20S.00T4 . xx

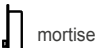

without return spring

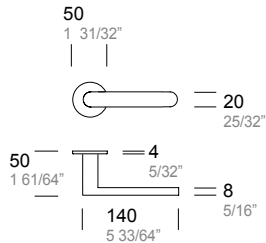

2MM.20S.0Uxx . xx

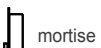

without return spring

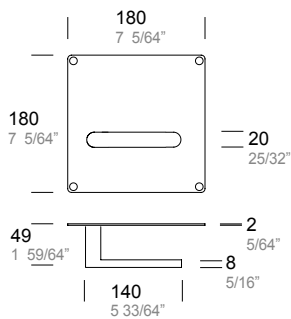

2MM.20S.0Uxx . xx



without return spring

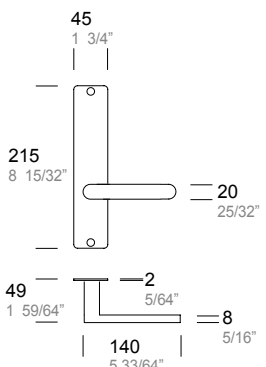

LOCK
WOOD OR HM DOORS

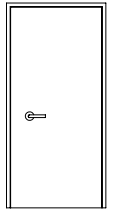
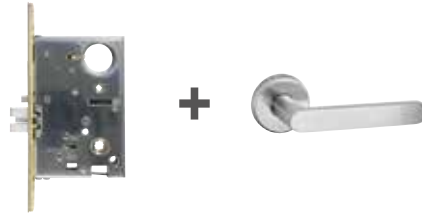

FUNCTION BACKSET HOW TO ORDER

PASSAGE ANSI F01	2 1/2" 2 3/4"	2MM.LCK.0A00 . xx ONLY LOCK	+	2MM.20S.0xTx . xx + 2MM.20S.0Uxx . xx + 2MM.20S.0Uxx . xx
OFFICE/CORRIDOR ANSI F04	2 1/2" 2 3/4"	2MM.LCK.0F00 . xx ONLY LOCK	+	2MM.20S.0xTx . xx + 2MM.20S.0Uxx . xx + 2MM.20S.0Uxx . xx
CLASSROOM ANSI F05	2 1/2" 2 3/4"	2MM.LCK.0G00 . xx ONLY LOCK	+	2MM.20S.0xTx . xx + 2MM.20S.0Uxx . xx + 2MM.20S.0Uxx . xx
STOREROOM ANSI F07	2 1/2" 2 3/4"	2MM.LCK.0P00 . xx ONLY LOCK	+	2MM.20S.0xTx . xx + 2MM.20S.0Uxx . xx + 2MM.20S.0Uxx . xx
OFFICE/ENTRY ANSI F04 + F13	2 1/2" 2 3/4"	2MM.LCK.0I00 . xx ONLY LOCK	+	2MM.20S.0xTx . xx Add thumbturns page Levers_127 + 2MM.20S.0Uxx . xx Add thumbturns page Levers_127 + 2MM.20S.0Uxx . xx Add thumbturns page Levers_127
DORMITORY ANSI F13	2 1/2" 2 3/4"	2MM.LCK.0E00 . xx ONLY LOCK	+	2MM.20S.0xTx . xx Add thumbturns page Levers_127 + 2MM.20S.0Uxx . xx Add thumbturns page Levers_127 + 2MM.20S.0Uxx . xx Add thumbturns page Levers_127
PRIVACY ANSI F19	2 1/2" 2 3/4"	2MM.LCK.0M00 . xx ONLY LOCK	+	2MM.20S.0xTx . xx Add thumbturns page Levers_127 + 2MM.20S.0Uxx . xx Add thumbturns page Levers_127 + 2MM.20S.0Uxx . xx Add thumbturns page Levers_127

.XX = FINISH CODE

- STAINLESS STEEL
- .43 BRIGHT STAINLESS STEEL (ANSI/BHMA 629 - USD32)
- .44 SATIN STAINLESS STEEL (ANSI/BHMA 630 - USD32D)

PVD ON REQUEST

- .83 BLACK SATIN
- Colors on demand, minimum lot to be agreed.
- Screws and grub screws not pvd

STAINLESS STEEL POWDER-COATED ON REQUEST

- .40 BLACK RAL 9005 MATT - TO MATCH WITH PBA BLACK ALUMINUM
- .26 BLACK RAL 9005 GLOSSY
- .31 WHITE RAL 9010
- .32 GREY
- .38 CHAMPAGNE
- .39 BRONZE - TO MATCH WITH PBA BRONZE ALUMINUM
- .36 ARCHITECTURAL BRONZE
- .56 MEDIUM BRONZE
- .41 SILVER
- .55 GOLD

- .99 COLORS ON REQUEST TO MATCH ANY RAL #
(screws, grub screws and plastic parts non powder-coated)
available on request depending on quantities

MORTISE LOCKS: SEE TECHNICAL INFORMATION FOR SOLID DOOR SECTION

MORTISE CYLINDERS NOT INCLUDED see page Levers_141
FOR COMPATIBLE MODELS

STANDARD FACEPLATE AND STRIKEPLATE SATIN STAINLESS STEEL.

SPINDLE DEPTH, LEVERS POSITION ON THE LOCKSET AND FIXING
(SINGLE OR BACK TO BACK) MUST BE SPECIFIED ORDERING - see page Levers_143

HANDLE FOR MORTISE
GLASS DOORS WITH ALUMINUM PROFILE
OR WOOD AND HM DOORS

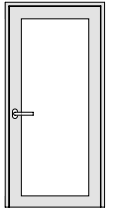

ITEM THESE PRODUCTS CONTRIBUTE TO **LEED®** CREDITS



2MM.20S.0008 . xx

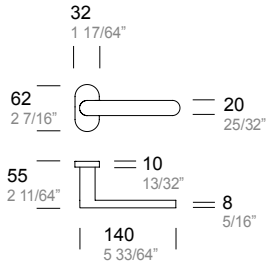

Ø with return spring

2MM.20S.0004 . xx

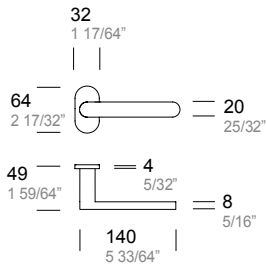

Ø without return spring

.XX = FINISH CODE

- .43 **STAINLESS STEEL**
- .43 BRIGHT STAINLESS STEEL (ANSI/BHMA 629 - USD32)
- .44 SATIN STAINLESS STEEL (ANSI/BHMA 630 - USD32D)

PVD ON REQUEST

- .83 BLACK SATIN
- Colors on demand, minimum lot to be agreed.
- Screws and grub screws not pvd

STAINLESS STEEL POWDER-COATED ON REQUEST

- .40 BLACK RAL 9005 MATT - TO MATCH WITH PBA BLACK ALUMINUM
- .26 BLACK RAL 9005 GLOSSY
- .31 WHITE RAL 9010
- .32 GREY
- .38 CHAMPAGNE
- .39 BRONZE - TO MATCH WITH PBA BRONZE ALUMINUM
- .36 ARCHITECTURAL BRONZE
- .56 MEDIUM BRONZE
- .41 SILVER
- .55 GOLD

- .99 COLORS ON REQUEST TO MATCH ANY RAL #
- (screws, grub screws and plastic parts non powder-coated)
- available on request depending on quantities

SPINDLE DEPTH, LEVERS POSITION ON THE LOCKSET AND FIXING
(SINGLE OR BACK TO BACK) MUST BE SPECIFIED ORDERING - see page Levers_143

P B A
PATENTED
DESIGN

PATENT
0000098918



ITEM

2MM.015.xxxx.xx

MATERIALS, FINISHING AND DETAILS

.XX = FINISH CODE

STAINLESS STEEL

.44 SATIN STAINLESS STEEL (ANSI/BHMA 630 - USD32D)



.43 BRIGHT STAINLESS STEEL (ANSI/BHMA 629 - USD32)

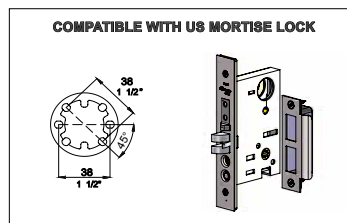
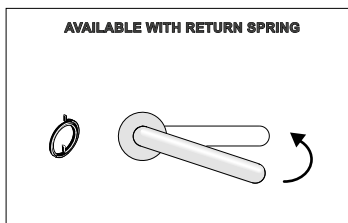

THESE PRODUCTS CONTRIBUTE TO **LEED®** CREDITS

THE MANUFACTURER RESERVES THE RIGHT TO ALTER, IMPROVE AND DISCONTINUE ANY FEATURES OF THE PRODUCT (MAKE CHANGES AND IMPROVEMENTS IN DESIGNS AND DIMENSIONS) WITHOUT NOTICE.

ALL DIMENSIONS IN THE CATALOG DRAWINGS ARE APPROXIMATIONS. REQUEST THE APPROPRIATE TECHNICAL DRAWING BEFORE DOOR PREPARATION AND INSTALLATION.

FIXING:

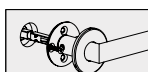

SINGLE SIDE FIXING

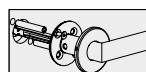

BACK TO BACK FIXING

HANDLE FOR MORTISE
WOOD OR HM DOORS



ITEM THESE PRODUCTS CONTRIBUTE TO LEED® CREDITS **Declare.**

2MM.015.0UT8 . xx



with return spring

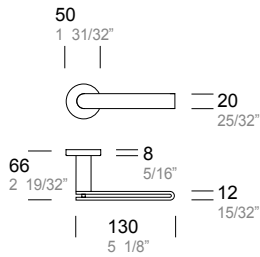

2MM.015.00T4 . xx

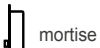

without return spring

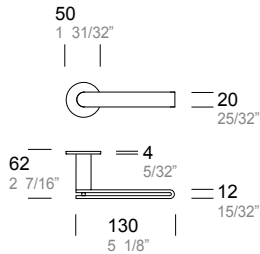

2MM.015.0Uxx . xx

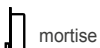

without return spring

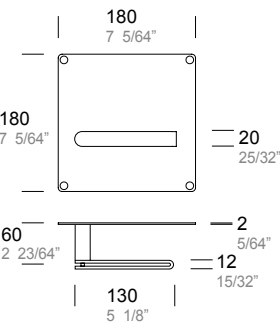

2MM.015.0Uxx . xx



without return spring

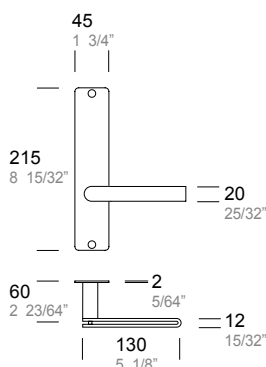

LOCK
WOOD OR HM DOORS

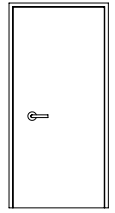
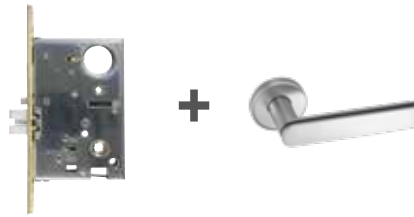

FUNCTION BACKSET HOW TO ORDER

PASSAGE ANSI F01 2 1/2" 2 3/4" 2MM.LCK.0A00 . xx + ONLY LOCK 2MM.015.0xTx . xx

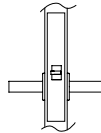

+ 2MM.015.0Uxx . xx
+ 2MM.015.0Uxx . xx

OFFICE/CORRIDOR ANSI F04 2 1/2" 2 3/4" 2MM.LCK.0F00 . xx + ONLY LOCK 2MM.015.0xTx . xx

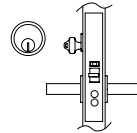

+ 2MM.015.0Uxx . xx
+ 2MM.015.0Uxx . xx

CLASSROOM ANSI F05 2 1/2" 2 3/4" 2MM.LCK.0G00 . xx + ONLY LOCK 2MM.015.0xTx . xx

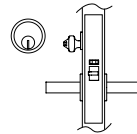

+ 2MM.015.0Uxx . xx
+ 2MM.015.0Uxx . xx

STOREROOM ANSI F07 2 1/2" 2 3/4" 2MM.LCK.0P00 . xx + ONLY LOCK 2MM.015.0xTx . xx

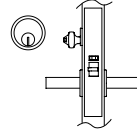

+ 2MM.015.0Uxx . xx
+ 2MM.015.0Uxx . xx

OFFICE/ENTRY ANSI F04 + F13 2 1/2" 2 3/4" 2MM.LCK.0I00 . xx + ONLY LOCK 2MM.015.0xTx . xx

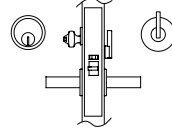

+ Add thumbturns page Levers_127
+ 2MM.015.0Uxx . xx
+ Add thumbturns page Levers_127
+ 2MM.015.0Uxx . xx
+ Add thumbturns page Levers_127

DORMITORY ANSI F13 2 1/2" 2 3/4" 2MM.LCK.0E00 . xx + ONLY LOCK 2MM.015.0xTx . xx

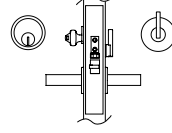

+ Add thumbturns page Levers_127
+ 2MM.015.0Uxx . xx
+ Add thumbturns page Levers_127
+ 2MM.015.0Uxx . xx
+ Add thumbturns page Levers_127

PRIVACY ANSI F19 2 1/2" 2 3/4" 2MM.LCK.0M00 . xx + ONLY LOCK 2MM.015.0xTx . xx

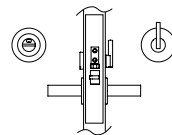

+ Add thumbturns page Levers_127
+ 2MM.015.0Uxx . xx
+ Add thumbturns page Levers_127
+ 2MM.015.0Uxx . xx
+ Add thumbturns page Levers_127

.XX = FINISH CODE

- STAINLESS STEEL
- .43 BRIGHT STAINLESS STEEL (ANSI/BHMA 629 - USD32)
- .44 SATIN STAINLESS STEEL (ANSI/BHMA 630 - USD32D)

MORTISE LOCKS: SEE TECHNICAL INFORMATION FOR SOLID DOOR SECTION

MORTISE CYLINDERS NOT INCLUDED see page Levers_141 FOR COMPATIBLE MODELS

STANDARD FACEPLATE AND STRIKEPLATE SATIN STAINLESS STEEL.

SPINDLE DEPTH, LEVERS POSITION ON THE LOCKSET AND FIXING (SINGLE OR BACK TO BACK) MUST BE SPECIFIED ORDERING - see page Levers_143

HANDLE FOR MORTISE

GLASS DOORS WITH ALUMINUM PROFILE
OR WOOD AND HM DOORS



Declare.

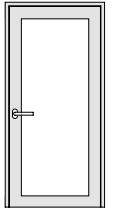

ITEM THESE PRODUCTS CONTRIBUTE TO **LEED®** CREDITS

2MM.015.0008 . xx

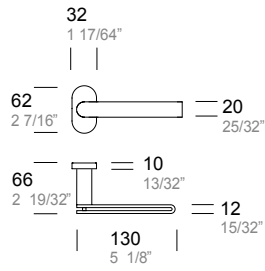

Ø with return spring

2MM.015.0004 . xx

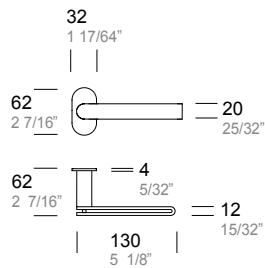

Ø without return spring

.XX = FINISH CODE

STAINLESS STEEL

- .43 BRIGHT STAINLESS STEEL (ANSI/BHMA 629 - USD32)
- .44 SATIN STAINLESS STEEL (ANSI/BHMA 630 - USD32D)

SPINDLE DEPTH, LEVERS POSITION ON THE LOCKSET AND FIXING
(SINGLE OR BACK TO BACK) MUST BE SPECIFIED ORDERING - see page Levers_143

HANDLE WITH LATCH
WOOD OR HM DOORS



ITEM	BACKSET	FUNCTION	
2MM.015.SA70 . xx	70 mm 2 3/4"	PASSAGE	
2MM.015.SA60 . xx	60 mm 2 3/8"		
latch included			
with return spring			

2MM.015.SB70 . xx	70 mm 2 3/4"	PRIVACY	
2MM.015.SB60 . xx	60 mm 2 3/8"		
latch included			
with return spring			

2MM.015.MA70 . xx	70 mm 2 3/4"	PASSAGE WITH MAGNETIC BOLT	
2MM.015.MA60 . xx	60 mm 2 3/8"		
latch included			
with return spring			

2MM.015.MB70 . xx	70 mm 2 3/4"	PRIVACY WITH MAGNETIC BOLT	
2MM.015.MB60 . xx	60 mm 2 3/8"		
latch included			
with return spring			

.XX = FINISH CODE
 STAINLESS STEEL
 .43 BRIGHT STAINLESS STEEL (ANSI/BHMA 629 - USD32)
 .44 SATIN STAINLESS STEEL (ANSI/BHMA 630 - USD32D)

HANDLE DUMMY
WOOD OR HM DOORS

THESE PRODUCTS CONTRIBUTE TO LEED® CREDITS



ITEM	BACKSET	FUNCTION	
2MM.015.0D06 . xx		SINGLE	
2MM.015.C0D6 . xx		PAIR	
dummy			
without return spring			

2MM.015.0D05 . xx		SINGLE	
2MM.015.C0D5 . xx		PAIR	
dummy			
without return spring			





ITEM

2MM.171.xxxx.xx











MATERIALS, FINISHING AND DETAILS

.XX = FINISH CODE

STAINLESS STEEL

- .44 SATIN STAINLESS STEEL (ANSI/BHMA 630 - USD32D) 
- .43 BRIGHT STAINLESS STEEL (ANSI/BHMA 629 - USD32) 

STAINLESS STEEL POWDER-COATED

- .40 BLACK RAL 9005 MAT - TO MATCH WITH PBA 
- .26 BLACK ALUMINUM 
- .31 WHITE RAL 9005 GLOSSY 
- .32 GREY 
- .38 CHAMPAGNE 
- .39 BRONZE - TO MATCH WITH PBA BRONZE ALUMINUM 
- .36 ARCHITECTURAL BRONZE 
- .56 MEDIUM BRONZE 
- .41 SILVER 
- .55 GOLD 
- .99 COLORS ON REQUEST TO MATCH ANY RAL #
(screws, grub screws and plastic parts non powder-coated).
Available on request depending on quantities.

PVD ON SELECTED ITEMS

- .83 BLACK SATIN 
Colors on demand, minimum lot to be agreed.
Screws and grub screws not pvd.

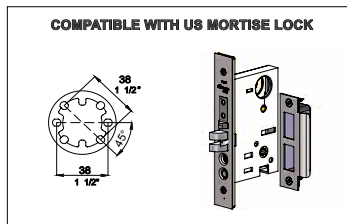
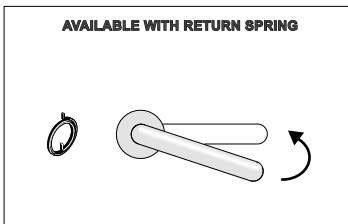

THESE PRODUCTS CONTRIBUTE TO LEED® CREDITS

THE MANUFACTURER RESERVES THE RIGHT TO ALTER, IMPROVE AND DISCONTINUE ANY FEATURES OF THE PRODUCT (MAKE CHANGES AND IMPROVEMENTS IN DESIGNS AND DIMENSIONS) WITHOUT NOTICE.

ALL DIMENSIONS IN THE CATALOG DRAWINGS ARE APPROXIMATIONS. REQUEST THE APPROPRIATE TECHNICAL DRAWING BEFORE DOOR PREPARATION AND INSTALLATION.

FIXING:

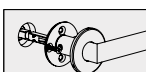

SINGLE SIDE FIXING

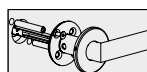

BACK TO BACK FIXING

HANDLE FOR MORTISE
WOOD OR HM DOORS



ITEM THESE PRODUCTS CONTRIBUTE TO LEED® CREDITS



2MM.171.0UT8 . xx



with return spring

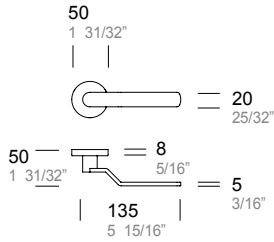

2MM.171.00T4 . xx

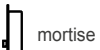

without return spring

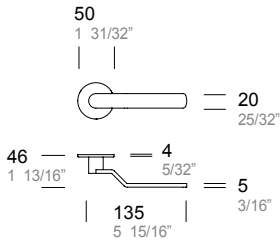

2MM.171.0Uxx . xx

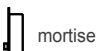

without return spring

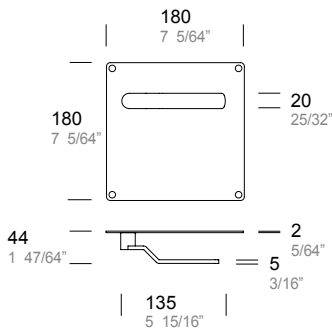

2MM.171.0Uxx . xx

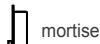

without return spring

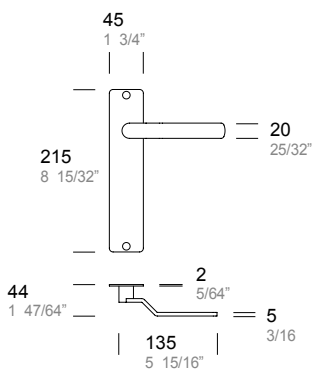

LOCK
WOOD OR HM DOORS

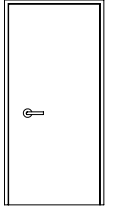
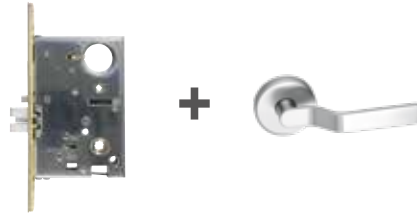

FUNCTION	BACKSET	HOW TO ORDER
PASSAGE ANSI F01	2 1/2" 2 3/4"	2MM.LCK.0A00 . xx + 2MM.171.0xTx . xx ONLY LOCK + 2MM.171.0Uxx . xx + 2MM.171.0Uxx . xx
OFFICE/CORRIDOR ANSI F04	2 1/2" 2 3/4"	2MM.LCK.0F00 . xx + 2MM.171.0xTx . xx ONLY LOCK + 2MM.171.0Uxx . xx + 2MM.171.0Uxx . xx
CLASSROOM ANSI F05	2 1/2" 2 3/4"	2MM.LCK.0G00 . xx + 2MM.171.0xTx . xx ONLY LOCK + 2MM.171.0Uxx . xx + 2MM.171.0Uxx . xx
STOREROOM ANSI F07	2 1/2" 2 3/4"	2MM.LCK.0P00 . xx + 2MM.171.0xTx . xx ONLY LOCK + 2MM.171.0Uxx . xx + 2MM.171.0Uxx . xx
OFFICE/ENTRY ANSI F04 + F13	2 1/2" 2 3/4"	2MM.LCK.0I00 . xx + 2MM.171.0xTx . xx ONLY LOCK + Add thumbturns page Levers_127 + 2MM.171.0Uxx . xx + Add thumbturns page Levers_127 + 2MM.171.0Uxx . xx + Add thumbturns page Levers_127
DORMITORY ANSI F13	2 1/2" 2 3/4"	2MM.LCK.0E00 . xx + 2MM.171.0xTx . xx ONLY LOCK + Add thumbturns page Levers_127 + 2MM.171.0Uxx . xx + Add thumbturns page Levers_127 + 2MM.171.0Uxx . xx + Add thumbturns page Levers_127
PRIVACY ANSI F19	2 1/2" 2 3/4"	2MM.LCK.0M00 . xx + 2MM.171.0xTx . xx ONLY LOCK + Add thumbturns page Levers_127 + 2MM.171.0Uxx . xx + Add thumbturns page Levers_127 + 2MM.171.0Uxx . xx + Add thumbturns page Levers_127

.XX = FINISH CODE

- STAINLESS STEEL
- .43 BRIGHT STAINLESS STEEL (ANSI/BHMA 629 - USD32)
- .44 SATIN STAINLESS STEEL (ANSI/BHMA 630 - USD32D)
- PVD ON REQUEST
- .83 BLACK SATIN
- Colors on demand, minimum lot to be agreed.
- Screws and grub screws not pvd

- STAINLESS STEEL POWDER-COATED ON REQUEST
- .40 BLACK RAL 9005 MATT - TO MATCH WITH PBA BLACK ALUMINUM
- .26 BLACK RAL 9005 GLOSSY
- .31 WHITE RAL 9010
- .32 GREY
- .38 CHAMPAGNE
- .39 BRONZE - TO MATCH WITH PBA BRONZE ALUMINUM
- .36 ARCHITECTURAL BRONZE
- .56 MEDIUM BRONZE
- .41 SILVER
- .55 GOLD

.99 COLORS ON REQUEST TO MATCH ANY RAL #
(screws, grub screws and plastic parts non powder-coated)
available on request depending on quantities

MORTISE LOCKS: SEE TECHNICAL INFORMATION FOR SOLID DOOR SECTION

MORTISE CYLINDERS NOT INCLUDED see page Levers_141
FOR COMPATIBLE MODELS

STANDARD FACEPLATE AND STRIKEPLATE SATIN STAINLESS STEEL.

SPINDLE DEPTH, LEVERS POSITION ON THE LOCKSET AND FIXING
(SINGLE OR BACK TO BACK) MUST BE SPECIFIED ORDERING - see page Levers_143

HANDLE FOR MORTISE

GLASS DOORS WITH ALUMINUM PROFILE
OR WOOD AND HM DOORS

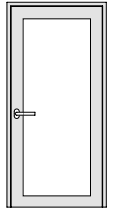

ITEM THESE PRODUCTS CONTRIBUTE TO **LEED®** CREDITS

2MM.171.0008 . xx

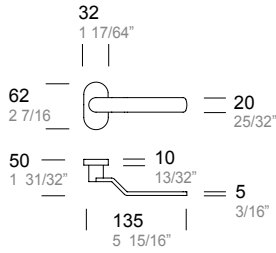

with return spring

2MM.171.0004 . xx

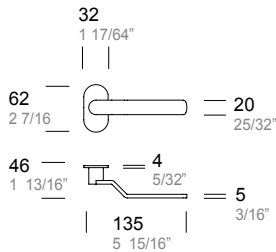

without return spring

.XX = FINISH CODE

- STAINLESS STEEL**
.43 BRIGHT STAINLESS STEEL (ANSI/BHMA 629 - USD32)
.44 SATIN STAINLESS STEEL (ANSI/BHMA 630 - USD32D)

- PVD ON REQUEST**
.83 BLACK SATIN
Colors on demand, minimum lot to be agreed.
Screws and grub screws not pvd

STAINLESS STEEL POWDER-COATED ON REQUEST

- .40 BLACK RAL 9005 MATT - TO MATCH WITH PBA BLACK ALUMINUM
.26 BLACK RAL 9005 GLOSSY
.31 WHITE RAL 9010
.32 GREY
.38 CHAMPAGNE
.39 BRONZE - TO MATCH WITH PBA BRONZE ALUMINUM
.36 ARCHITECTURAL BRONZE
.56 MEDIUM BRONZE
.41 SILVER
.55 GOLD

- .99 COLORS ON REQUEST TO MATCH ANY RAL #
(screws, grub screws and plastic parts non powder-coated)
available on request depending on quantities

SPINDLE DEPTH, LEVERS POSITION ON THE LOCKSET AND FIXING
(SINGLE OR BACK TO BACK) MUST BE SPECIFIED ORDERING - see page Levers_143

HANDLE WITH LATCH
WOOD OR HM DOORS



LIM - DESIGN DIMITRI SAUTIER
FOR FRANKLIN AZZURRO ARCHITECTURE



ITEM BACKSET FUNCTION

2MM.171.SA70 . xx	70 mm 2 3/4"	PASSAGE	
2MM.171.SA60 . xx	60 mm 2 3/8"		
latch included			
with return spring			



2MM.171.SB70 . xx	70 mm 2 3/4"	PRIVACY	
2MM.171.SB60 . xx	60 mm 2 3/8"		
latch included			
with return spring			



2MM.171.MA70 . xx	70 mm 2 3/4"	PASSAGE WITH MAGNETIC BOLT	
2MM.171.MA60 . xx	60 mm 2 3/8"		
latch included			
with return spring			



2MM.171.MB70 . xx	70 mm 2 3/4"	PRIVACY WITH MAGNETIC BOLT	
2MM.171.MB60 . xx	60 mm 2 3/8"		
latch included			
with return spring			



HANDLE DUMMY
WOOD OR HM DOORS

THESE PRODUCTS CONTRIBUTE TO LEED® CREDITS



ITEM

2MM.171.0D06 . xx	SINGLE	
2MM.171.C0D6 . xx	PAIR	
dummy		
without return spring		

2MM.171.0D05 . xx	SINGLE	
2MM.171.C0D5 . xx	PAIR	
dummy		
without return spring		

.XX = FINISH CODE

- .43 STAINLESS STEEL
- .43 BRIGHT STAINLESS STEEL (ANSI/BHMA 629 - USD32)
- .44 SATIN STAINLESS STEEL (ANSI/BHMA 630 - USD32D)

PVD ON REQUEST

- .83 BLACK SATIN
- Colors on demand, minimum lot to be agreed.
- Screws and grub screws not pvd

STAINLESS STEEL POWDER-COATED ON REQUEST

- .40 BLACK RAL 9005 MATT- TO MATCH WITH PBA BLACK ALUMINUM
- .26 BLACK RAL 9005 GLOSSY
- .31 WHITE RAL 9010
- .32 GREY
- .38 CHAMPAGNE
- .39 BRONZE - TO MATCH WITH PBA BRONZE ALUMINUM
- .36 ARCHITECTURAL BRONZE
- .56 MEDIUM BRONZE
- .41 SILVER
- .55 GOLD

- .99 COLORS ON REQUEST TO MATCH ANY RAL #
- (screws, grub screws and plastic parts non powder-coated)
- available on request depending on quantities

LATCH DETAILS
page Levers_145





ITEM

2MM.022.xxxx.xx











MATERIALS, FINISHING AND DETAILS

.XX = FINISH CODE

STAINLESS STEEL

- .44 SATIN STAINLESS STEEL (ANSI/BHMA 630 - USD32D) 
- .43 BRIGHT STAINLESS STEEL (ANSI/BHMA 629 - USD32) 

STAINLESS STEEL POWDER-COATED

- .40 BLACK RAL 9005 MATT - TO MATCH WITH PBA 
- .26 BLACK ALUMINUM 
- .31 WHITE RAL 9005 GLOSSY 
- .32 GREY 
- .38 CHAMPAGNE 
- .39 BRONZE - TO MATCH WITH PBA BRONZE ALUMINUM 
- .36 ARCHITECTURAL BRONZE 
- .56 MEDIUM BRONZE 
- .41 SILVER 
- .55 GOLD 
- .99 COLORS ON REQUEST TO MATCH ANY RAL #
(screws, grub screws and plastic parts non powder-coated).
Available on request depending on quantities.

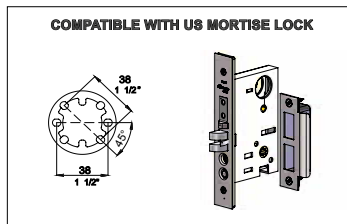
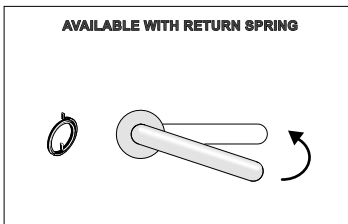

THESE PRODUCTS CONTRIBUTE TO LEED® CREDITS

THE MANUFACTURER RESERVES THE RIGHT TO ALTER, IMPROVE AND DISCONTINUE ANY FEATURES OF THE PRODUCT (MAKE CHANGES AND IMPROVEMENTS IN DESIGNS AND DIMENSIONS) WITHOUT NOTICE.

ALL DIMENSIONS IN THE CATALOG DRAWINGS ARE APPROXIMATIONS. REQUEST THE APPROPRIATE TECHNICAL DRAWING BEFORE DOOR PREPARATION AND INSTALLATION.

FIXING:

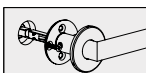

SINGLE SIDE FIXING

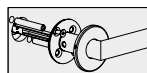

BACK TO BACK FIXING

HANDLE FOR MORTISE
WOOD OR HM DOORS



ITEM THESE PRODUCTS CONTRIBUTE TO LEED® CREDITS

2MM.022.0UT8 . xx

- mortise
- with return spring

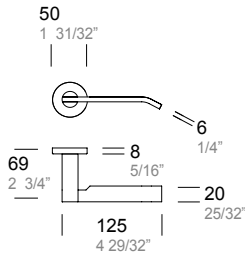

2MM.022.00T4 . xx

- mortise
- without return spring

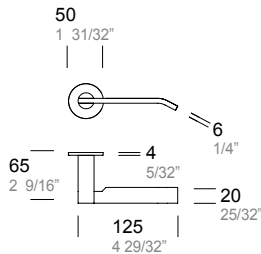

2MM.022.0Uxx . xx

- mortise
- without return spring

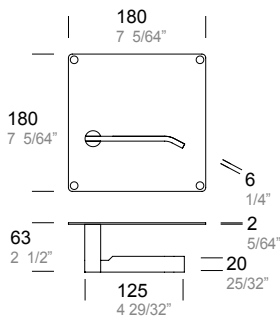

2MM.022.0Uxx . xx

- mortise
- without return spring

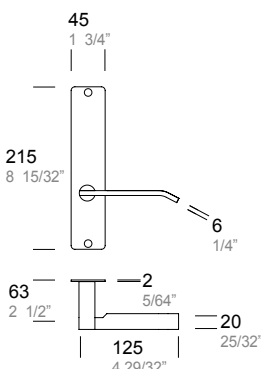

LOCK
WOOD OR HM DOORS



FUNCTION	BACKSET	HOW TO ORDER
PASSAGE ANSI F01	2 1/2" 2 3/4"	2MM.LCK.0A00 . xx + 2MM.022.0xTx . xx ONLY LOCK + 2MM.022.0Uxx . xx + 2MM.022.0Uxx . xx
OFFICE/CORRIDOR ANSI F04	2 1/2" 2 3/4"	2MM.LCK.0F00 . xx + 2MM.022.0xTx . xx ONLY LOCK + 2MM.022.0Uxx . xx + 2MM.022.0Uxx . xx
CLASSROOM ANSI F05	2 1/2" 2 3/4"	2MM.LCK.0G00 . xx + 2MM.022.0xTx . xx ONLY LOCK + 2MM.022.0Uxx . xx + 2MM.022.0Uxx . xx
STOREROOM ANSI F07	2 1/2" 2 3/4"	2MM.LCK.0P00 . xx + 2MM.022.0xTx . xx ONLY LOCK + 2MM.022.0Uxx . xx + 2MM.022.0Uxx . xx
OFFICE/ENTRY ANSI F04 + F13	2 1/2" 2 3/4"	2MM.LCK.0I00 . xx + 2MM.022.0xTx . xx ONLY LOCK + Add thumbturns page Levers_127 2MM.022.0Uxx . xx + Add thumbturns page Levers_127 2MM.022.0Uxx . xx + Add thumbturns page Levers_127
DORMITORY ANSI F13	2 1/2" 2 3/4"	2MM.LCK.0E00 . xx + 2MM.022.0xTx . xx ONLY LOCK + Add thumbturns page Levers_127 2MM.022.0Uxx . xx + Add thumbturns page Levers_127 2MM.022.0Uxx . xx + Add thumbturns page Levers_127
PRIVACY ANSI F19	2 1/2" 2 3/4"	2MM.LCK.0M00 . xx + 2MM.022.0xTx . xx ONLY LOCK + Add thumbturns page Levers_127 2MM.022.0Uxx . xx + Add thumbturns page Levers_127 2MM.022.0Uxx . xx + Add thumbturns page Levers_127

XX = FINISH CODE

- STAINLESS STEEL**
- .43 BRIGHT STAINLESS STEEL (ANSI/BHMA 629 - USD32)
 - .44 SATIN STAINLESS STEEL (ANSI/BHMA 630 - USD32D)
- .99 COLORS ON REQUEST TO MATCH ANY RAL #
(screws, grub screws and plastic parts non powder-coated)
available on request depending on quantities

- STAINLESS STEEL POWDER-COATED ON REQUEST**
- .40 BLACK RAL 9005 MATT - TO MATCH WITH PBA BLACK ALUMINUM
 - .26 BLACK RAL 9005 GLOSSY
 - .31 WHITE RAL 9010
 - .32 GREY
 - .38 CHAMPAGNE
 - .39 BRONZE - TO MATCH WITH PBA BRONZE ALUMINUM
 - .36 ARCHITECTURAL BRONZE
 - .56 MEDIUM BRONZE
 - .41 SILVER
 - .55 GOLD

MORTISE LOCKS: SEE TECHNICAL INFORMATION FOR SOLID DOOR SECTION
 MORTISE CYLINDERS NOT INCLUDED see page Levers_141
 FOR COMPATIBLE MODELS
 STANDARD FACEPLATE AND STRIKEPLATE SATIN STAINLESS STEEL.
 SPINDLE DEPTH, LEVERS POSITION ON THE LOCKSET AND FIXING
 (SINGLE OR BACK TO BACK) MUST BE SPECIFIED ORDERING - see page Levers_143

HANDLE FOR MORTISE
GLASS DOORS WITH ALUMINUM PROFILE
OR WOOD AND HM DOORS

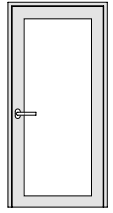

ITEM THESE PRODUCTS CONTRIBUTE TO **LEED®** CREDITS

2MM.022.0008 . xx

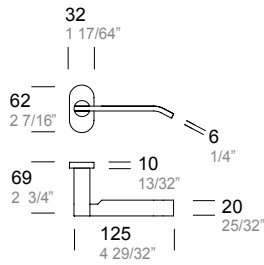

with return spring

2MM.022.0004 . xx

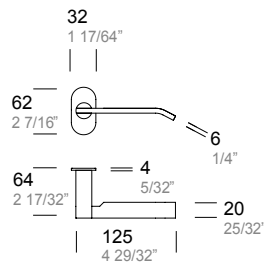

without return spring

.XX = FINISH CODE

- STAINLESS STEEL**
- .43 BRIGHT STAINLESS STEEL (ANSI/BHMA 629 - USD32)
- .44 SATIN STAINLESS STEEL (ANSI/BHMA 630 - USD32D)

- .99 COLORS ON REQUEST TO MATCH ANY RAL #
(screws, grub screws and plastic parts non powder-coated)
available on request depending on quantities

- STAINLESS STEEL POWDER-COATED ON REQUEST**
- .40 BLACK RAL 9005 MATT - TO MATCH WITH PBA BLACK ALUMINUM
- .26 BLACK RAL 9005 GLOSSY
- .31 WHITE RAL 9010
- .32 GREY
- .38 CHAMPAGNE
- .39 BRONZE - TO MATCH WITH PBA BRONZE ALUMINUM
- .36 ARCHITECTURAL BRONZE
- .56 MEDIUM BRONZE
- .41 SILVER
- .55 GOLD

SPINDLE DEPTH, LEVERS POSITION ON THE LOCKSET AND FIXING
(SINGLE OR BACK TO BACK) MUST BE SPECIFIED ORDERING - see page Levers_143

HANDLE WITH LATCH
WOOD OR HM DOORS



ITEM BACKSET FUNCTION

2MM.022.SA70 . xx	70 mm 2 3/4"	PASSAGE	
2MM.022.SA60 . xx	60 mm 2 3/8"		

latch included

with return spring



2MM.022.SB70 . xx	70 mm 2 3/4"	PRIVACY	
2MM.022.SB60 . xx	60 mm 2 3/8"		

latch included

with return spring



2MM.022.MA70 . xx	70 mm 2 3/4"	PASSAGE WITH MAGNETIC BOLT	
2MM.022.MA60 . xx	60 mm 2 3/8"		

latch included

with return spring



2MM.022.MB70 . xx	70 mm 2 3/4"	PRIVACY WITH MAGNETIC BOLT	
2MM.022.MB60 . xx	60 mm 2 3/8"		

latch included

with return spring



.XX = FINISH CODE

- STAINLESS STEEL**
- .43 BRIGHT STAINLESS STEEL (ANSI/BHMA 629 - USD32)
 - .44 SATIN STAINLESS STEEL (ANSI/BHMA 630 - USD32D)
- .99 COLORS ON REQUEST TO MATCH ANY RAL #
(screws, grub screws and plastic parts non powder-coated)
available on request depending on quantities

- STAINLESS STEEL POWDER-COATED ON REQUEST**
- .40 BLACK RAL 9005 MATT - TO MATCH WITH PBA BLACK ALUMINUM
 - .26 BLACK RAL 9005 GLOSSY
 - .31 WHITE RAL 9010
 - .32 GREY
 - .38 CHAMPAGNE
 - .39 BRONZE - TO MATCH WITH PBA BRONZE ALUMINUM
 - .36 ARCHITECTURAL BRONZE
 - .56 MEDIUM BRONZE
 - .41 SILVER
 - .55 GOLD

HANDLE DUMMY
WOOD OR HM DOORS

THESE PRODUCTS CONTRIBUTE TO LEED® CREDITS



ITEM BACKSET FUNCTION

2MM.022.0D06 . xx	SINGLE	
2MM.022.C0D6 . xx	PAIR	

dummy

without return spring

2MM.022.0D05 . xx	SINGLE	
2MM.022.C0D5 . xx	PAIR	

dummy

without return spring





ITEM

2MM.172.xxxx.xx











MATERIALS, FINISHING AND DETAILS

.XX = FINISH CODE

STAINLESS STEEL

- .44 SATIN STAINLESS STEEL (ANSI/BHMA 630 - USD32D) 
- .43 BRIGHT STAINLESS STEEL (ANSI/BHMA 629 - USD32) 

STAINLESS STEEL POWDER-COATED

- .40 BLACK RAL 9005 MATT - TO MATCH WITH PBA 
- .26 BLACK ALUMINUM 
- .31 WHITE RAL 9005 GLOSSY 
- .32 GREY 
- .38 CHAMPAGNE 
- .39 BRONZE - TO MATCH WITH PBA BRONZE ALUMINUM 
- .36 ARCHITECTURAL BRONZE 
- .56 MEDIUM BRONZE 
- .41 SILVER 
- .55 GOLD 
- .99 COLORS ON REQUEST TO MATCH ANY RAL #
(screws, grub screws and plastic parts non powder-coated).
Available on request depending on quantities.

PVD ON SELECTED ITEMS

- .83 BLACK SATIN 
Colors on demand, minimum lot to be agreed.
Screws and grub screws not pvd.

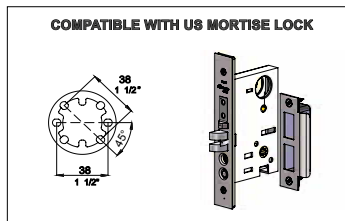

THESE PRODUCTS CONTRIBUTE TO LEED® CREDITS

THE MANUFACTURER RESERVES THE RIGHT TO ALTER, IMPROVE AND DISCONTINUE ANY FEATURES OF THE PRODUCT (MAKE CHANGES AND IMPROVEMENTS IN DESIGNS AND DIMENSIONS) WITHOUT NOTICE.

ALL DIMENSIONS IN THE CATALOG DRAWINGS ARE APPROXIMATIONS. REQUEST THE APPROPRIATE TECHNICAL DRAWING BEFORE DOOR PREPARATION AND INSTALLATION.

FIXING:

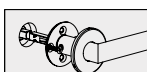

SINGLE SIDE FIXING

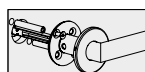

BACK TO BACK FIXING

HANDLE FOR MORTISE
WOOD OR HM DOORS



ITEM THESE PRODUCTS CONTRIBUTE TO LEED® CREDITS **Declare.**

2MM.172.0UT8 . xx

- mortise
- with return spring

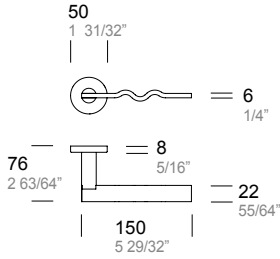

2MM.172.00T4 . xx

- mortise
- without return spring

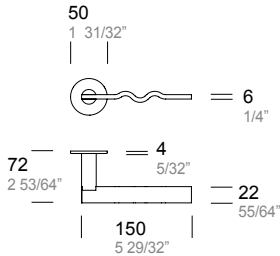

2MM.172.0Uxx . xx

- mortise
- without return spring

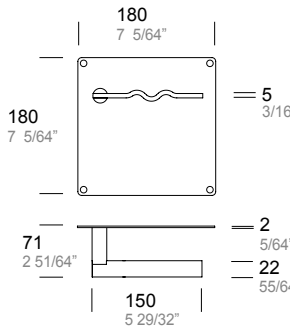

2MM.172.0Uxx . xx

- mortise
- without return spring

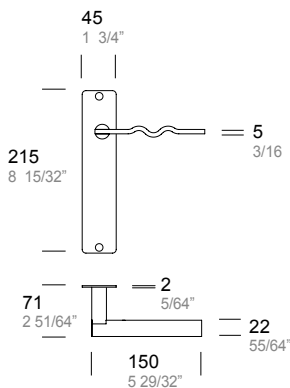

LOCK
WOOD OR HM DOORS

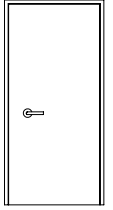

FUNCTION BACKSET HOW TO ORDER

PASSAGE ANSI F01 2 1/2" 2 3/4" **2MM.LCK.0A00 . xx** + **2MM.172.0xTx . xx**
 ONLY LOCK + **2MM.172.0Uxx . xx**

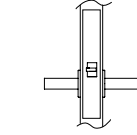

OFFICE/CORRIDOR ANSI F04 2 1/2" 2 3/4" **2MM.LCK.0F00 . xx** + **2MM.172.0xTx . xx**
 ONLY LOCK + **2MM.172.0Uxx . xx**

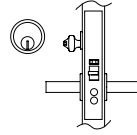

CLASSROOM ANSI F05 2 1/2" 2 3/4" **2MM.LCK.0G00 . xx** + **2MM.172.0xTx . xx**
 ONLY LOCK + **2MM.172.0Uxx . xx**

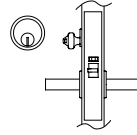

STOREROOM ANSI F07 2 1/2" 2 3/4" **2MM.LCK.0P00 . xx** + **2MM.172.0xTx . xx**
 ONLY LOCK + **2MM.172.0Uxx . xx**

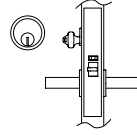

OFFICE/ENTRY ANSI F04 + F13 2 1/2" 2 3/4" **2MM.LCK.0I00 . xx** + **2MM.172.0xTx . xx**
 ONLY LOCK + Add thumbturns page Levers_127

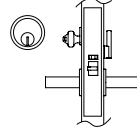

DORMITORY ANSI F13 2 1/2" 2 3/4" **2MM.LCK.0E00 . xx** + **2MM.172.0xTx . xx**
 ONLY LOCK + Add thumbturns page Levers_127

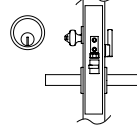

PRIVACY ANSI F19 2 1/2" 2 3/4" **2MM.LCK.0M00 . xx** + **2MM.172.0xTx . xx**
 ONLY LOCK + Add thumbturns page Levers_127

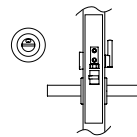

.XX = FINISH CODE

- STAINLESS STEEL
- .43 BRIGHT STAINLESS STEEL (ANSI/BHMA 629 - USD32)
- .44 SATIN STAINLESS STEEL (ANSI/BHMA 630 - USD32D)

PVD ON REQUEST

- .83 BLACK SATIN
- Colors on demand, minimum lot to be agreed.
- Screws and grub screws not pvd

STAINLESS STEEL POWDER-COATED ON REQUEST

- .40 BLACK RAL 9005 MATT - TO MATCH WITH PBA BLACK ALUMINUM
- .26 BLACK RAL 9005 GLOSSY
- .31 WHITE RAL 9010
- .32 GREY
- .38 CHAMPAGNE
- .39 BRONZE - TO MATCH WITH PBA BRONZE ALUMINUM
- .36 ARCHITECTURAL BRONZE
- .56 MEDIUM BRONZE
- .41 SILVER
- .55 GOLD

- .99 COLORS ON REQUEST TO MATCH ANY RAL # (screws, grub screws and plastic parts non powder-coated) available on request depending on quantities

MORTISE LOCKS: SEE TECHNICAL INFORMATION FOR SOLID DOOR SECTION

MORTISE CYLINDERS NOT INCLUDED see page Levers_141 FOR COMPATIBLE MODELS

STANDARD FACEPLATE AND STRIKEPLATE SATIN STAINLESS STEEL.

SPINDLE DEPTH, LEVERS POSITION ON THE LOCKSET AND FIXING (SINGLE OR BACK TO BACK) MUST BE SPECIFIED ORDERING - see page Levers_143

HANDLE FOR MORTISE
GLASS DOORS WITH ALUMINUM PROFILE
OR WOOD AND HM DOORS



Declare.

ITEM THESE PRODUCTS CONTRIBUTE TO **LEED®** CREDITS

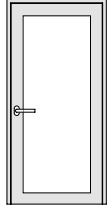

2MM.172.0008 . xx

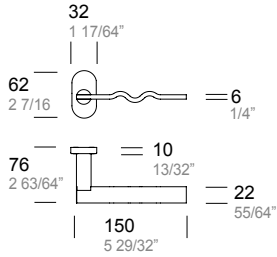

with return spring

2MM.172.0004 . xx

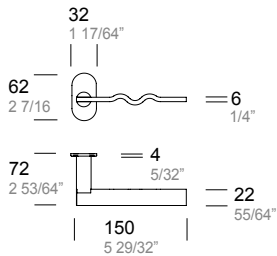

without return spring

.XX = FINISH CODE

- STAINLESS STEEL**
- .43 BRIGHT STAINLESS STEEL (ANSI/BHMA 629 - USD32)
- .44 SATIN STAINLESS STEEL (ANSI/BHMA 630 - USD32D)

PVD ON REQUEST

- .83 BLACK SATIN
- Colors on demand, minimum lot to be agreed.
- Screws and grub screws not pvd

STAINLESS STEEL POWDER-COATED ON REQUEST

- .40 BLACK RAL 9005 MATT - TO MATCH WITH PBA BLACK ALUMINUM
- .26 BLACK RAL 9005 GLOSSY
- .31 WHITE RAL 9010
- .32 GREY
- .38 CHAMPAGNE
- .39 BRONZE - TO MATCH WITH PBA BRONZE ALUMINUM
- .36 ARCHITECTURAL BRONZE
- .56 MEDIUM BRONZE
- .41 SILVER
- .55 GOLD

- .99 COLORS ON REQUEST TO MATCH ANY RAL #
- (screws, grub screws and plastic parts non powder-coated)
- available on request depending on quantities

SPINDLE DEPTH, LEVERS POSITION ON THE LOCKSET AND FIXING
(SINGLE OR BACK TO BACK) MUST BE SPECIFIED ORDERING - see page Levers_143

HANDLE WITH LATCH
WOOD OR HM DOORS



VAGUE - DESIGN ANNE DEMIANS



ITEM BACKSET FUNCTION

2MM.172.SA70 . xx	70 mm 2 3/4"	PASSAGE	
2MM.172.SA60 . xx	60 mm 2 3/8"		
latch included			
with return spring			

2MM.172.SB70 . xx	70 mm 2 3/4"	PRIVACY	
2MM.172.SB60 . xx	60 mm 2 3/8"		
latch included			
with return spring			

2MM.172.MA70 . xx	70 mm 2 3/4"	PASSAGE WITH MAGNETIC BOLT	
2MM.172.MA60 . xx	60 mm 2 3/8"		
latch included			
with return spring			

2MM.172.MB70 . xx	70 mm 2 3/4"	PRIVACY WITH MAGNETIC BOLT	
2MM.172.MB60 . xx	60 mm 2 3/8"		
latch included			
with return spring			

HANDLE DUMMY
WOOD OR HM DOORS

THESE PRODUCTS CONTRIBUTE TO LEED® CREDITS



ITEM

2MM.172.0D06 . xx	SINGLE	
2MM.172.C0D6 . xx	PAIR	
dummy		
without return spring		

2MM.172.0D05 . xx	SINGLE	
2MM.172.C0D5 . xx	PAIR	
dummy		
without return spring		

.XX = FINISH CODE

- .43 STAINLESS STEEL
- .43 BRIGHT STAINLESS STEEL (ANSI/BHMA 629 - USD32)
- .44 SATIN STAINLESS STEEL (ANSI/BHMA 630 - USD32D)

PVD ON REQUEST

- .83 BLACK SATIN
- Colors on demand, minimum lot to be agreed.
- Screws and grub screws not pvd

STAINLESS STEEL POWDER-COATED ON REQUEST

- .40 BLACK RAL 9005 MATT. TO MATCH WITH PBA BLACK ALUMINUM
- .26 BLACK RAL 9005 GLOSSY
- .31 WHITE RAL 9010
- .32 GREY
- .38 CHAMPAGNE
- .39 BRONZE - TO MATCH WITH PBA BRONZE ALUMINUM
- .36 ARCHITECTURAL BRONZE
- .56 MEDIUM BRONZE
- .41 SILVER
- .55 GOLD

- .99 COLORS ON REQUEST TO MATCH ANY RAL #
- (screws, grub screws and plastic parts non powder-coated)
- available on request depending on quantities

LATCH DETAILS
page Levers_145

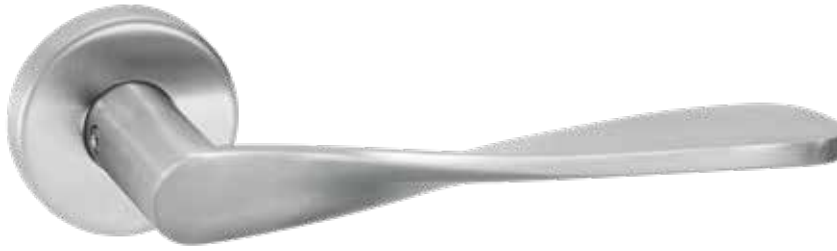



ITEM

2MM.175.xxxx.xx











MATERIALS, FINISHING AND DETAILS

.XX = FINISH CODE

STAINLESS STEEL

- .44 SATIN STAINLESS STEEL (ANSI/BHMA 630 - USD32D)** 
- .43 BRIGHT STAINLESS STEEL (ANSI/BHMA 629 - USD32)** 

STAINLESS STEEL POWDER-COATED

- .40 BLACK RAL 9005 MATT - TO MATCH WITH PBA** 
- .26 BLACK ALUMINUM** 
- .31 WHITE RAL 9005 GLOSSY** 
- .32 GREY** 
- .38 CHAMPAGNE** 
- .39 BRONZE - TO MATCH WITH PBA BRONZE ALUMINUM** 
- .36 ARCHITECTURAL BRONZE** 
- .56 MEDIUM BRONZE** 
- .41 SILVER** 
- .55 GOLD** 
- .99 COLORS ON REQUEST TO MATCH ANY RAL #**
(screws, grub screws and plastic parts non powder-coated).
Available on request depending on quantities.

PVD ON SELECTED ITEMS

- .83 BLACK SATIN** 
Colors on demand, minimum lot to be agreed.
Screws and grub screws not pvd.

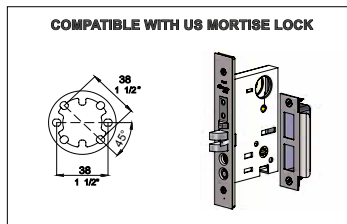
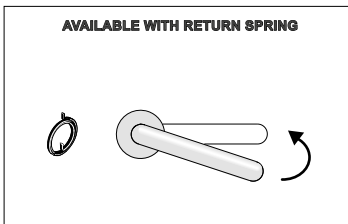

THESE PRODUCTS CONTRIBUTE TO **LEED®** CREDITS

THE MANUFACTURER RESERVES THE RIGHT TO ALTER, IMPROVE AND DISCONTINUE ANY FEATURES OF THE PRODUCT (MAKE CHANGES AND IMPROVEMENTS IN DESIGNS AND DIMENSIONS) WITHOUT NOTICE.

ALL DIMENSIONS IN THE CATALOG DRAWINGS ARE APPROXIMATIONS. REQUEST THE APPROPRIATE TECHNICAL DRAWING BEFORE DOOR PREPARATION AND INSTALLATION.

FIXING:

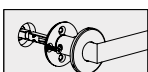

SINGLE SIDE FIXING

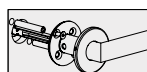

BACK TO BACK FIXING

HANDLE FOR MORTISE
WOOD OR HM DOORS



ITEM THESE PRODUCTS CONTRIBUTE TO LEED® CREDITS

2MM.175.0UT8 . xx



mortise

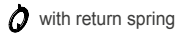

with return spring

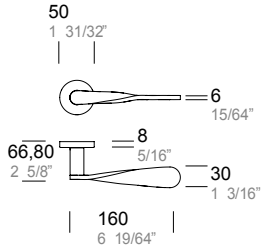

2MM.175.00T4 . xx



mortise

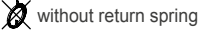



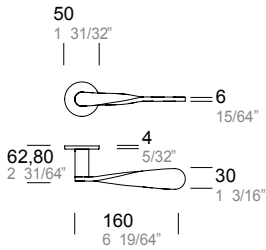



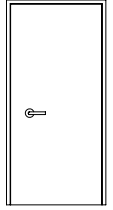

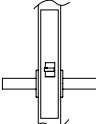

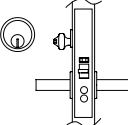

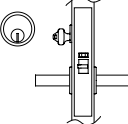

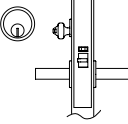
without return spring

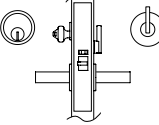

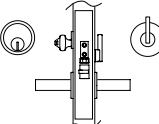
LOCK
WOOD OR HM DOORS

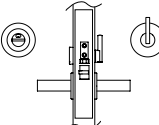

FUNCTION	BACKSET	HOW TO ORDER
PASSAGE ANSI F01 	2 1/2" 2 3/4"	2MM.LCK.0A00 . xx +  ONLY LOCK 2MM.175.0xTx . xx
OFFICE/CORRIDOR ANSI F04 	2 1/2" 2 3/4"	2MM.LCK.0F00 . xx +  ONLY LOCK 2MM.175.0xTx . xx
CLASSROOM ANSI F05 	2 1/2" 2 3/4"	2MM.LCK.0G00 . xx +  ONLY LOCK 2MM.175.0xTx . xx
STOREROOM ANSI F07 	2 1/2" 2 3/4"	2MM.LCK.0P00 . xx +  ONLY LOCK 2MM.175.0xTx . xx
OFFICE/ENTRY ANSI F04 + F13 	2 1/2" 2 3/4"	2MM.LCK.0I00 . xx +  ONLY LOCK 2MM.175.0xTx . xx  Add thumbturns page Levers_127
DORMITORY ANSI F13 	2 1/2" 2 3/4"	2MM.LCK.0E00 . xx +  ONLY LOCK 2MM.175.0xTx . xx  Add thumbturns page Levers_127
PRIVACY ANSI F19 	2 1/2" 2 3/4"	2MM.LCK.0M00 . xx +  ONLY LOCK 2MM.175.0xTx . xx  Add thumbturns page Levers_127

.XX = FINISH CODE

- STAINLESS STEEL**
- .43 BRIGHT STAINLESS STEEL (ANSI/BHMA 629 - USD32)
 - .44 SATIN STAINLESS STEEL (ANSI/BHMA 630 - USD32D)

- PVD ON REQUEST**
- BLACK SATIN
 - .83 Colors on demand, minimum lot to be agreed.
Screws and grub screws not pvd

- STAINLESS STEEL POWDER-COATED ON REQUEST**
- .40 BLACK RAL 9005 MATT - TO MATCH WITH PBA BLACK ALUMINUM
 - .26 BLACK RAL 9005 GLOSSY
 - .31 WHITE RAL 9010
 - .32 GREY
 - .38 CHAMPAGNE
 - .39 BRONZE - TO MATCH WITH PBA BRONZE ALUMINUM
 - .36 ARCHITECTURAL BRONZE
 - .56 MEDIUM BRONZE
 - .41 SILVER
 - .55 GOLD

- .99 COLORS ON REQUEST TO MATCH ANY RAL #
(screws, grub screws and plastic parts non powder-coated)
available on request depending on quantities

MORTISE LOCKS: SEE TECHNICAL INFORMATION FOR SOLID DOOR SECTION

MORTISE CYLINDERS NOT INCLUDED see page Levers_141
FOR COMPATIBLE MODELS

STANDARD FACEPLATE AND STRIKEPLATE SATIN STAINLESS STEEL.

SPINDLE DEPTH, LEVERS POSITION ON THE LOCKSET AND FIXING
(SINGLE OR BACK TO BACK) MUST BE SPECIFIED ORDERING - see page Levers_143





ITEM

2MM.174.xxxx.xx











MATERIALS, FINISHING AND DETAILS

.XX = FINISH CODE

STAINLESS STEEL

- .44 SATIN STAINLESS STEEL (ANSI/BHMA 630 - USD32D)** 
- .43 BRIGHT STAINLESS STEEL (ANSI/BHMA 629 - USD32)** 

STAINLESS STEEL POWDER-COATED

- .40 BLACK RAL 9005 MATT - TO MATCH WITH PBA** 
- .26 BLACK ALUMINUM** 
- .31 WHITE RAL 9005 GLOSSY** 
- .32 GREY** 
- .38 CHAMPAGNE** 
- .39 BRONZE - TO MATCH WITH PBA BRONZE ALUMINUM** 
- .36 ARCHITECTURAL BRONZE** 
- .56 MEDIUM BRONZE** 
- .41 SILVER** 
- .55 GOLD** 
- .99 COLORS ON REQUEST TO MATCH ANY RAL #**
(screws, grub screws and plastic parts non powder-coated).
Available on request depending on quantities.

PVD ON SELECTED ITEMS

- .83 BLACK SATIN** 
Colors on demand, minimum lot to be agreed.
Screws and grub screws not pvd.

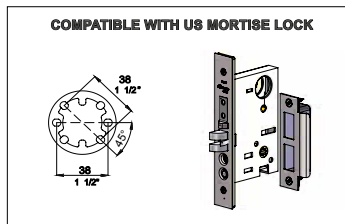

THESE PRODUCTS CONTRIBUTE TO **LEED®** CREDITS

THE MANUFACTURER RESERVES THE RIGHT TO ALTER, IMPROVE AND DISCONTINUE ANY FEATURES OF THE PRODUCT (MAKE CHANGES AND IMPROVEMENTS IN DESIGNS AND DIMENSIONS) WITHOUT NOTICE.

ALL DIMENSIONS IN THE CATALOG DRAWINGS ARE APPROXIMATIONS. REQUEST THE APPROPRIATE TECHNICAL DRAWING BEFORE DOOR PREPARATION AND INSTALLATION.

FIXING:

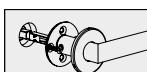

SINGLE SIDE FIXING

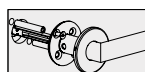

BACK TO BACK FIXING

HANDLE FOR MORTISE
WOOD OR HM DOORS



ITEM THESE PRODUCTS CONTRIBUTE TO LEED® CREDITS **Declare.**

2MM.174.0UT8 . xx

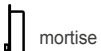

with return spring

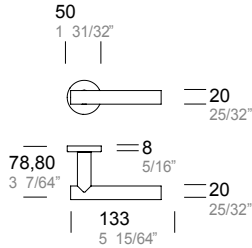

2MM.174.00T4 . xx

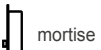

without return spring

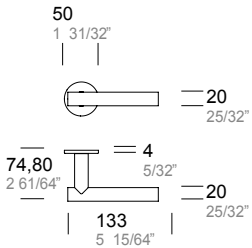

LOCK
WOOD OR HM DOORS

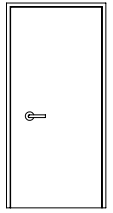
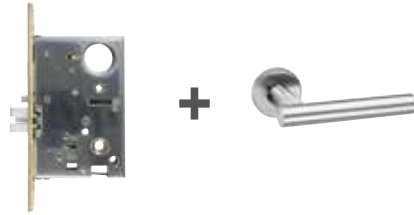

FUNCTION	BACKSET	HOW TO ORDER
PASSAGE ANSI F01 	2 1/2" 2 3/4"	2MM.LCK.0A00 . xx + 2MM.174.0xTx . xx ONLY LOCK
OFFICE/CORRIDOR ANSI F04 	2 1/2" 2 3/4"	2MM.LCK.0F00 . xx + 2MM.174.0xTx . xx ONLY LOCK
CLASSROOM ANSI F05 	2 1/2" 2 3/4"	2MM.LCK.0G00 . xx + 2MM.174.0xTx . xx ONLY LOCK
STOREROOM ANSI F07 	2 1/2" 2 3/4"	2MM.LCK.0P00 . xx + 2MM.174.0xTx . xx ONLY LOCK
OFFICE/ENTRY ANSI F04 + F13 	2 1/2" 2 3/4"	2MM.LCK.0I00 . xx + 2MM.174.0xTx . xx ONLY LOCK Add thumbturns page Levers_127
DORMITORY ANSI F13 	2 1/2" 2 3/4"	2MM.LCK.0E00 . xx + 2MM.174.0xTx . xx ONLY LOCK Add thumbturns page Levers_127
PRIVACY ANSI F19 	2 1/2" 2 3/4"	2MM.LCK.0M00 . xx + 2MM.174.0xTx . xx ONLY LOCK Add thumbturns page Levers_127

.XX = FINISH CODE

WOOD	STAINLESS STEEL
.46 WENGÉ SATIN STAINLESS STEEL (ANSI/BHMA 630 - USD32D)	.40 BLACK RAL 9005 - TO MATCH WITH PBA BLACK ALUMINUM
.49 WENGÉ BRIGHT STAINLESS STEEL (ANSI/BHMA 629 - USD32)	.31 WHITE RAL 9010
.47 ASH SATIN STAINLESS STEEL (ANSI/BHMA 630 - USD32D)	.32 GREY
.50 ASH BRIGHT STAINLESS STEEL (ANSI/BHMA 629 - USD32)	.38 CHAMPAGNE
.48 MAHOGANY SATIN STAINLESS STEEL (ANSI/BHMA 630 - USD32D)	.39 BRONZE - TO MATCH WITH PBA BRONZE ALUMINUM
.51 MAHOGANY BRIGHT STAINLESS STEEL (ANSI/BHMA 629 - USD32)	.41 SILVER
PVD ON REQUEST	.99 COLORS ON REQUEST TO MATCH ANY RAL #
.83 BLACK SATIN	(screws, grub screws and plastic parts non powder-coated)
Colors on demand, minimum lot to be agreed. Screws and grub screws not pvd	available on request depending on quantities

MORTISE LOCKS: SEE TECHNICAL INFORMATION FOR SOLID DOOR SECTION
MORTISE CYLINDERS NOT INCLUDED see page Levers_141
FOR COMPATIBLE MODELS
STANDARD FACEPLATE AND STRIKEPLATE SATIN STAINLESS STEEL.
SPINDLE DEPTH, LEVERS POSITION ON THE LOCKSET AND FIXING
(SINGLE OR BACK TO BACK) MUST BE SPECIFIED ORDERING - see page Levers_143



ITEM

YOD.001.xxxx.xx

MATERIALS, FINISHING AND DETAILS

.XX = FINISH CODE

MATT CLEAR COATED WOOD		STAINLESS STEEL	
.46	WENGÈ	SATIN STAINLESS STEEL (ANSI/BHMA 630 - USD32D)	
.49	WENGÈ	BRIGHT STAINLESS STEEL (ANSI/BHMA 629 - USD32)	
.47	ASH	SATIN STAINLESS STEEL (ANSI/BHMA 630 - USD32D)	
.50	ASH	BRIGHT STAINLESS STEEL (ANSI/BHMA 629 - USD32)	
.48	MAHOGANY	SATIN STAINLESS STEEL (ANSI/BHMA 630 - USD32D)	
.51	MAHOGANY	BRIGHT STAINLESS STEEL (ANSI/BHMA 629 - USD32)	

PVD ON SELECTED ITEMS

.83	BLACK SATIN	
------------	-------------	--

Colors on demand, minimum lot to be agreed.
Screws and grub screws not pvd.

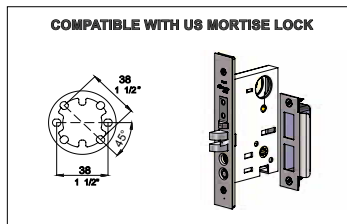
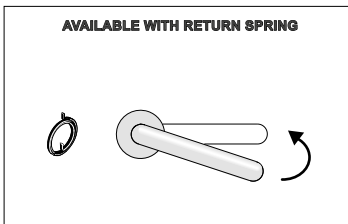

THESE PRODUCTS CONTRIBUTE TO LEED® CREDITS

THE MANUFACTURER RESERVES THE RIGHT TO ALTER, IMPROVE AND DISCONTINUE ANY FEATURES OF THE PRODUCT (MAKE CHANGES AND IMPROVEMENTS IN DESIGNS AND DIMENSIONS) WITHOUT NOTICE.

ALL DIMENSIONS IN THE CATALOG DRAWINGS ARE APPROXIMATIONS. REQUEST THE APPROPRIATE TECHNICAL DRAWING BEFORE DOOR PREPARATION AND INSTALLATION.

FIXING:

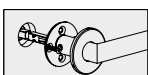

SINGLE SIDE FIXING

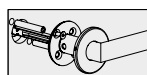

BACK TO BACK FIXING

HANDLE FOR MORTISE
WOOD OR HM DOORS



ITEM THESE PRODUCTS CONTRIBUTE TO LEED® CREDITS

YOD.001.0UT8 . xx



with return spring

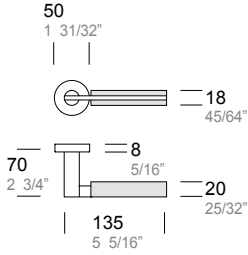

YOD.001.00T4 . xx

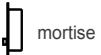

without return spring

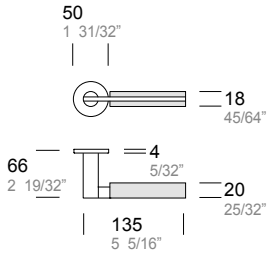

YOD.001.0Uxx . xx



without return spring

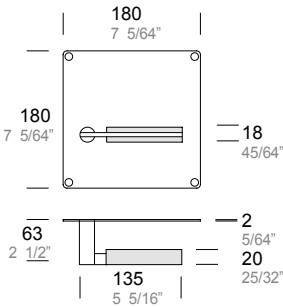

YOD.001.0Uxx . xx



without return spring

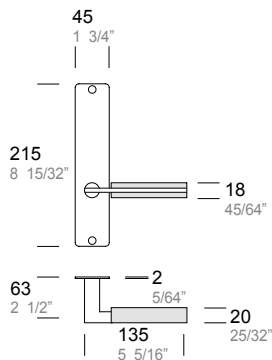

LOCK
WOOD OR HM DOORS

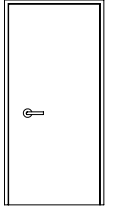
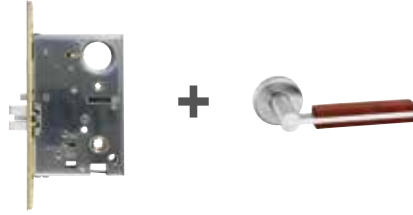

FUNCTION	BACKSET	HOW TO ORDER
PASSAGE ANSI F01	2 1/2" 2 3/4"	2MM.LCK.0A00 . xx + ONLY LOCK + YOD.001.0UTx . xx + YOD.001.0Uxx . xx + YOD.001.0Uxx . xx
OFFICE/CORRIDOR ANSI F04	2 1/2" 2 3/4"	2MM.LCK.0F00 . xx + ONLY LOCK + YOD.001.0Uxx . xx + YOD.001.0Uxx . xx
CLASSROOM ANSI F05	2 1/2" 2 3/4"	2MM.LCK.0G00 . xx + ONLY LOCK + YOD.001.0Uxx . xx + YOD.001.0Uxx . xx
STOREROOM ANSI F07	2 1/2" 2 3/4"	2MM.LCK.0P00 . xx + ONLY LOCK + YOD.001.0Uxx . xx + YOD.001.0Uxx . xx
OFFICE/ENTRY ANSI F04 + F13	2 1/2" 2 3/4"	2MM.LCK.0I00 . xx + ONLY LOCK + Add thumbturns page Levers_127 YOD.001.0Uxx . xx + Add thumbturns page Levers_127 YOD.001.0Uxx . xx + Add thumbturns page Levers_127
DORMITORY ANSI F13	2 1/2" 2 3/4"	2MM.LCK.0E00 . xx + ONLY LOCK + Add thumbturns page Levers_127 YOD.001.0Uxx . xx + Add thumbturns page Levers_127 YOD.001.0Uxx . xx + Add thumbturns page Levers_127
PRIVACY ANSI F19	2 1/2" 2 3/4"	2MM.LCK.0M00 . xx + ONLY LOCK + Add thumbturns page Levers_127 YOD.001.0Uxx . xx + Add thumbturns page Levers_127 YOD.001.0Uxx . xx + Add thumbturns page Levers_127

.XX = FINISH CODE

MATT CLEAR COATED WOOD
.46 WENGÉ
.49 WENGÉ
.47 ASH
.50 ASH
.48 MAHOGANY
.51 MAHOGANY

STAINLESS STEEL
SATIN STAINLESS STEEL (ANSI/BHMA 630 - USD32D)
BRIGHT STAINLESS STEEL (ANSI/BHMA 629 - USD32)
SATIN STAINLESS STEEL (ANSI/BHMA 630 - USD32D)
BRIGHT STAINLESS STEEL (ANSI/BHMA 629 - USD32)
SATIN STAINLESS STEEL (ANSI/BHMA 630 - USD32D)
BRIGHT STAINLESS STEEL (ANSI/BHMA 629 - USD32)

PVD ON REQUEST

.83 BLACK SATIN
Colors on demand, minimum lot to be agreed. Screws and grub screws not pvd

MORTISE LOCKS: SEE TECHNICAL INFORMATION FOR SOLID DOOR SECTION
MORTISE CYLINDERS NOT INCLUDED see page Levers_141
FOR COMPATIBLE MODELS

STANDARD FACEPLATE AND STRIKEPLATE SATIN STAINLESS STEEL.

SPINDLE DEPTH, LEVERS POSITION ON THE LOCKSET AND FIXING
(SINGLE OR BACK TO BACK) MUST BE SPECIFIED ORDERING - see page Levers_143

HANDLE WITH LATCH
WOOD OR HM DOORS



ITEM BACKSET FUNCTION

YOD.001.SA70 . xx	70 mm 2 3/4"	PASSAGE	
YOD.001.SA60 . xx	60 mm 2 3/8"		
latch included			
with return spring			



YOD.001.SB70 . xx	70 mm 2 3/4"	PRIVACY	
YOD.001.SB60 . xx	60 mm 2 3/8"		
latch included			
with return spring			



YOD.001.MA70 . xx	70 mm 2 3/4"	PASSAGE WITH MAGNETIC BOLT	
YOD.001.MA60 . xx	60 mm 2 3/8"		
latch included			
with return spring			



YOD.001.MB70 . xx	70 mm 2 3/4"	PRIVACY WITH MAGNETIC BOLT	
YOD.001.MB60 . xx	60 mm 2 3/8"		
latch included			
with return spring			



.XX = FINISH CODE

MATT CLEAR COATED WOOD	STAINLESS STEEL
.46 WENGÉ	SATIN STAINLESS STEEL (ANSI/BHMA 630 - USD32D)
.49 WENGÉ	BRIGHT STAINLESS STEEL (ANSI/BHMA 629 - USD32)
.47 ASH	SATIN STAINLESS STEEL (ANSI/BHMA 630 - USD32D)
.50 ASH	BRIGHT STAINLESS STEEL (ANSI/BHMA 629 - USD32)
.48 MAHOGANY	SATIN STAINLESS STEEL (ANSI/BHMA 630 - USD32D)
.51 MAHOGANY	BRIGHT STAINLESS STEEL (ANSI/BHMA 629 - USD32)

PVD ON REQUEST
.83 BLACK SATIN
Colors on demand, minimum lot to be agreed. Screws and grub screws not pvd

HANDLE DUMMY
WOOD OR HM DOORS

THESE PRODUCTS CONTRIBUTE TO LEED® CREDITS



ITEM

YOD.001.0D06 . xx	SINGLE	
YOD.001.C0D6 . xx	PAIR	
dummy		
without return spring		

YOD.001.0D05 . xx	SINGLE	
YOD.001.C0D5 . xx	PAIR	
dummy		
without return spring		



ITEM

STA.001.0UT8.xx

MATERIALS, FINISHING AND DETAILS

.XX = FINISH CODE

STAINLESS STEEL AISI 316L		ALUMINUM	
.4K	SATIN	SILVER	
.4M	SATIN	BRONZE	
.4N	SATIN	BLACK	
.3K	BRIGHT	SILVER	
.3M	BRIGHT	BRONZE	
.3N	BRIGHT	BLACK	

**Screws, grub screws and plastic parts non powder-coated.
Available on request depending on quantities.**

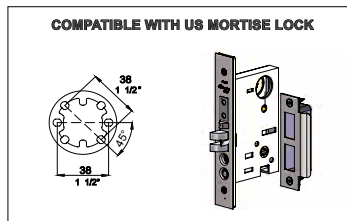

THESE PRODUCTS CONTRIBUTE TO **LEED®** CREDITS

THE MANUFACTURER RESERVES THE RIGHT TO ALTER, IMPROVE AND DISCONTINUE ANY FEATURES OF THE PRODUCT (MAKE CHANGES AND IMPROVEMENTS IN DESIGNS AND DIMENSIONS) WITHOUT NOTICE.

ALL DIMENSIONS IN THE CATALOG DRAWINGS ARE APPROXIMATIONS. REQUEST THE APPROPRIATE TECHNICAL DRAWING BEFORE DOOR PREPARATION AND INSTALLATION.

FIXING:

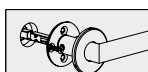

SINGLE SIDE FIXING

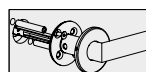

BACK TO BACK FIXING

HANDLE FOR MORTISE
WOOD OR HM DOORS



ITEM THESE PRODUCTS CONTRIBUTE TO LEED® CREDITS

STA.001.0UT8 . xx

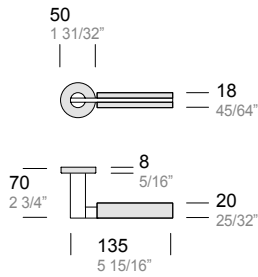

mortise

with return spring

Stainless Steel
 Aluminium



.4K



.4M



.4N

LOCK
WOOD OR HM DOORS

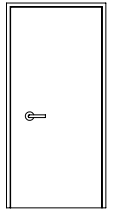

FUNCTION

BACKSET

HOW TO ORDER

PASSAGE
ANSI F01

2 1/2"
2 3/4"

2MM.LCK.0A00 . xx + ONLY LOCK

STA.001.0UT8 . xx

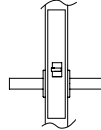

OFFICE/CORRIDOR
ANSI F04

2 1/2"
2 3/4"

2MM.LCK.0F00 . xx + ONLY LOCK

STA.001.0UT8 . xx

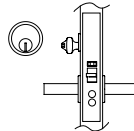

CLASSROOM
ANSI F05

2 1/2"
2 3/4"

2MM.LCK.0G00 . xx + ONLY LOCK

STA.001.0UT8 . xx

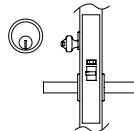

STOREROOM
ANSI F07

2 1/2"
2 3/4"

2MM.LCK.0P00 . xx + ONLY LOCK

STA.001.0UT8 . xx

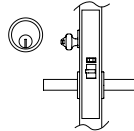

OFFICE/ENTRY
ANSI F04 + F13

2 1/2"
2 3/4"

2MM.LCK.0I00 . xx + ONLY LOCK

STA.001.0UT8 . xx
 Add thumbturns
page Levers_127

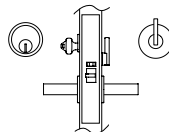

DORMITORY
ANSI F13

2 1/2"
2 3/4"

2MM.LCK.0E00 . xx + ONLY LOCK

STA.001.0UT8 . xx
 Add thumbturns
page Levers_127

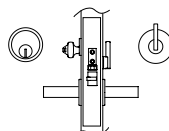

PRIVACY
ANSI F19

2 1/2"
2 3/4"

2MM.LCK.0M00 . xx + ONLY LOCK

STA.001.0UT8 . xx
 Add thumbturns
page Levers_127

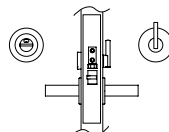

.XX = FINISH CODE

STAINLESS STEEL		ALUMINUM	
.4K	BRIGHT STAINLESS STEEL (ANSI/BHMA 629 - USD32)	SILVER	
.44	BRIGHT STAINLESS STEEL (ANSI/BHMA 629 - USD32)	BRONZE	
.4N	BRIGHT STAINLESS STEEL (ANSI/BHMA 629 - USD32)	BLACK	
.3K	SATIN STAINLESS STEEL (ANSI/BHMA 630 - USD32D)	SILVER	
.34	SATIN STAINLESS STEEL (ANSI/BHMA 630 - USD32D)	BRONZE	
.3N	SATIN STAINLESS STEEL (ANSI/BHMA 630 - USD32D)	BLACK	

MORTISE LOCKS: SEE TECHNICAL INFORMATION FOR SOLID DOOR SECTION

MORTISE CYLINDERS NOT INCLUDED see page Levers_141
FOR COMPATIBLE MODELS

STANDARD FACEPLATE AND STRIKEPLATE SATIN STAINLESS STEEL.

SPINDLE DEPTH, LEVERS POSITION ON THE LOCKSET AND FIXING
(SINGLE OR BACK TO BACK) MUST BE SPECIFIED ORDERING - see page Levers_143



ITEM

STA.002.0UT8.xx

MATERIALS, FINISHING AND DETAILS

.XX = FINISH CODE

STAINLESS STEEL AISI 316L		ALUMINUM	
.4K	SATIN	SILVER	
.4M	SATIN	BRONZE	
.4N	SATIN	BLACK	
.3K	BRIGHT	SILVER	
.3M	BRIGHT	BRONZE	
.3N	BRIGHT	BLACK	

Screws, grub screws and plastic parts non powder-coated.
Available on request depending on quantities.

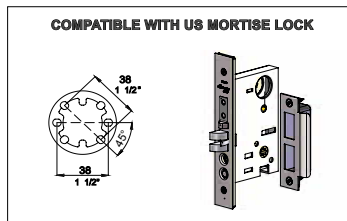

THESE PRODUCTS CONTRIBUTE TO LEED® CREDITS

THE MANUFACTURER RESERVES THE RIGHT TO ALTER, IMPROVE AND DISCONTINUE ANY FEATURES OF THE PRODUCT (MAKE CHANGES AND IMPROVEMENTS IN DESIGNS AND DIMENSIONS) WITHOUT NOTICE.

ALL DIMENSIONS IN THE CATALOG DRAWINGS ARE APPROXIMATIONS. REQUEST THE APPROPRIATE TECHNICAL DRAWING BEFORE DOOR PREPARATION AND INSTALLATION.

FIXING:

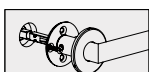

SINGLE SIDE FIXING

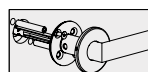

BACK TO BACK FIXING

HANDLE FOR MORTISE
WOOD OR HM DOORS



ITEM THESE PRODUCTS CONTRIBUTE TO LEED® CREDITS

STA.002.0UT8 . xx

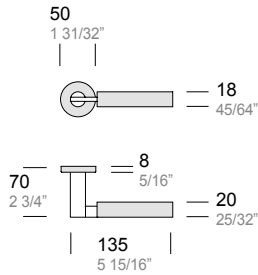

mortise

with return spring

Stainless Steel
 Aluminium



.4K



.4M



.4N

LOCK
WOOD OR HM DOORS

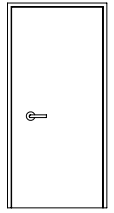
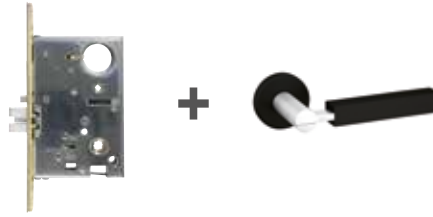

FUNCTION

BACKSET

HOW TO ORDER

PASSAGE
ANSI F01

2 1/2"
2 3/4"

2MM.LCK.0A00 . xx + ONLY LOCK

STA.002.0UT8 . xx

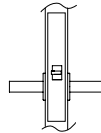

OFFICE/CORRIDOR
ANSI F04

2 1/2"
2 3/4"

2MM.LCK.0F00 . xx + ONLY LOCK

STA.002.0UT8 . xx

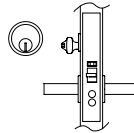

CLASSROOM
ANSI F05

2 1/2"
2 3/4"

2MM.LCK.0G00 . xx + ONLY LOCK

STA.002.0UT8 . xx

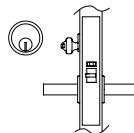

STOREROOM
ANSI F07

2 1/2"
2 3/4"

2MM.LCK.0P00 . xx + ONLY LOCK

STA.002.0UT8 . xx

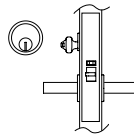

OFFICE/ENTRY
ANSI F04 + F13

2 1/2"
2 3/4"

2MM.LCK.0I00 . xx + ONLY LOCK

STA.002.0UT8 . xx
 Add thumbturns
page Levers_127

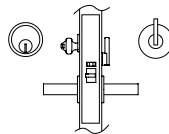

DORMITORY
ANSI F13

2 1/2"
2 3/4"

2MM.LCK.0E00 . xx + ONLY LOCK

STA.002.0UT8 . xx
 Add thumbturns
page Levers_127

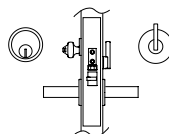

PRIVACY
ANSI F19

2 1/2"
2 3/4"

2MM.LCK.0M00 . xx + ONLY LOCK

STA.002.0UT8 . xx
 Add thumbturns
page Levers_127

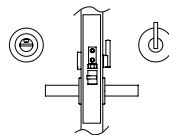

.XX = FINISH CODE

STAINLESS STEEL		ALUMINUM	
.4K	BRIGHT STAINLESS STEEL (ANSI/BHMA 629 - USD32)	SILVER	
.44	BRIGHT STAINLESS STEEL (ANSI/BHMA 629 - USD32)	BRONZE	
.4N	BRIGHT STAINLESS STEEL (ANSI/BHMA 629 - USD32)	BLACK	
.3K	SATIN STAINLESS STEEL (ANSI/BHMA 630 - USD32D)	SILVER	
.34	SATIN STAINLESS STEEL (ANSI/BHMA 630 - USD32D)	BRONZE	
.3N	SATIN STAINLESS STEEL (ANSI/BHMA 630 - USD32D)	BLACK	

MORTISE LOCKS: SEE TECHNICAL INFORMATION FOR SOLID DOOR SECTION

MORTISE CYLINDERS NOT INCLUDED see page Levers_141
FOR COMPATIBLE MODELS

STANDARD FACEPLATE AND STRIKEPLATE SATIN STAINLESS STEEL.

SPINDLE DEPTH, LEVERS POSITION ON THE LOCKSET AND FIXING
(SINGLE OR BACK TO BACK) MUST BE SPECIFIED ORDERING - see page Levers_143



ITEM

STA.003.0UT8.xx

MATERIALS, FINISHING AND DETAILS

.XX = FINISH CODE

STAINLESS STEEL AISI 316L		ALUMINUM	
.4K	SATIN	SILVER	
.4M	SATIN	BRONZE	
.4N	SATIN	BLACK	
.3K	BRIGHT	SILVER	
.3M	BRIGHT	BRONZE	
.3N	BRIGHT	BLACK	

Screws, grub screws and plastic parts non powder-coated.
Available on request depending on quantities.

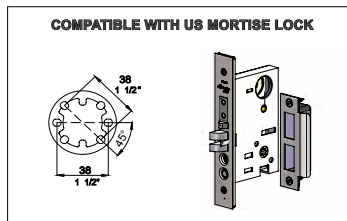
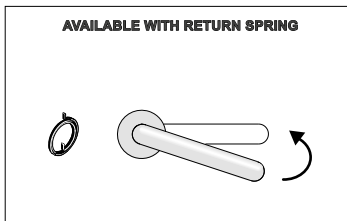

THESE PRODUCTS CONTRIBUTE TO LEED® CREDITS

THE MANUFACTURER RESERVES THE RIGHT TO ALTER, IMPROVE AND DISCONTINUE ANY FEATURES OF THE PRODUCT (MAKE CHANGES AND IMPROVEMENTS IN DESIGNS AND DIMENSIONS) WITHOUT NOTICE.

ALL DIMENSIONS IN THE CATALOG DRAWINGS ARE APPROXIMATIONS. REQUEST THE APPROPRIATE TECHNICAL DRAWING BEFORE DOOR PREPARATION AND INSTALLATION.

FIXING:

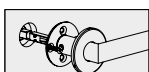

SINGLE SIDE FIXING

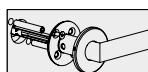

BACK TO BACK FIXING

HANDLE FOR MORTISE
WOOD OR HM DOORS



ITEM THESE PRODUCTS CONTRIBUTE TO LEED® CREDITS

STA.003.0UT8 . xx



mortise

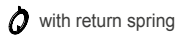

with return spring

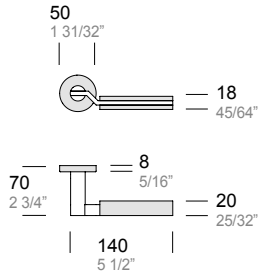

- Stainless Steel
- Aluminium



.4K



.4M



.4N

LOCK
WOOD OR HM DOORS



FUNCTION	BACKSET	HOW TO ORDER
PASSAGE ANSI F01	2 1/2" 2 3/4"	2MM.LCK.0A00 . xx + STA.003.0UT8 . xx ONLY LOCK
OFFICE/CORRIDOR ANSI F04	2 1/2" 2 3/4"	2MM.LCK.0F00 . xx + STA.003.0UT8 . xx ONLY LOCK
CLASSROOM ANSI F05	2 1/2" 2 3/4"	2MM.LCK.0G00 . xx + STA.003.0UT8 . xx ONLY LOCK
STOREROOM ANSI F07	2 1/2" 2 3/4"	2MM.LCK.0P00 . xx + STA.003.0UT8 . xx ONLY LOCK
OFFICE/ENTRY ANSI F04 + F13	2 1/2" 2 3/4"	2MM.LCK.0I00 . xx + STA.003.0UT8 . xx ONLY LOCK Add thumbturns page Levers_127
DORMITORY ANSI F13	2 1/2" 2 3/4"	2MM.LCK.0E00 . xx + STA.003.0UT8 . xx ONLY LOCK Add thumbturns page Levers_127
PRIVACY ANSI F19	2 1/2" 2 3/4"	2MM.LCK.0M00 . xx + STA.003.0UT8 . xx ONLY LOCK Add thumbturns page Levers_127

.XX = FINISH CODE

STAINLESS STEEL		ALUMINUM	
.4K	BRIGHT STAINLESS STEEL (ANSI/BHMA 629 - USD32)	SILVER	
.44	BRIGHT STAINLESS STEEL (ANSI/BHMA 629 - USD32)	BRONZE	
.4N	BRIGHT STAINLESS STEEL (ANSI/BHMA 629 - USD32)	BLACK	
.3K	SATIN STAINLESS STEEL (ANSI/BHMA 630 - USD32D)	SILVER	
.34	SATIN STAINLESS STEEL (ANSI/BHMA 630 - USD32D)	BRONZE	
.3N	SATIN STAINLESS STEEL (ANSI/BHMA 630 - USD32D)	BLACK	

MORTISE LOCKS: SEE MORTISE FOR SQUAD DOOR SECTION

MORTISE CYLINDERS NOT INCLUDED see page Levers_141
FOR COMPATIBLE MODELS

STANDARD FACEPLATE AND STRIKEPLATE SATIN STAINLESS STEEL.

SPINDLE DEPTH, LEVERS POSITION ON THE LOCKSET AND FIXING
(SINGLE OR BACK TO BACK) MUST BE SPECIFIED ORDERING - see page Levers_143



ITEM

YOD.002.xxxx.xx

MATERIALS, FINISHING AND DETAILS

.XX = FINISH CODE

MATT CLEAR COATED WOOD		STAINLESS STEEL	
.46	WENGÈ	SATIN STAINLESS STEEL (ANSI/BHMA 630 - USD32D)	
.49	WENGÈ	BRIGHT STAINLESS STEEL (ANSI/BHMA 629 - USD32)	
.47	ASH	SATIN STAINLESS STEEL (ANSI/BHMA 630 - USD32D)	
.50	ASH	BRIGHT STAINLESS STEEL (ANSI/BHMA 629 - USD32)	
.48	MAHOGANY	SATIN STAINLESS STEEL (ANSI/BHMA 630 - USD32D)	
.51	MAHOGANY	BRIGHT STAINLESS STEEL (ANSI/BHMA 629 - USD32)	
PVD ON SELECTED ITEMS			
.83	BLACK SATIN		

Colors on demand, minimum lot to be agreed.
Screws and grub screws not pvd.

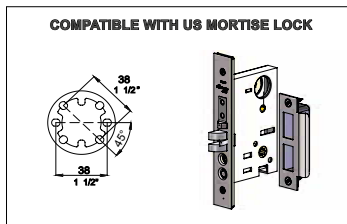
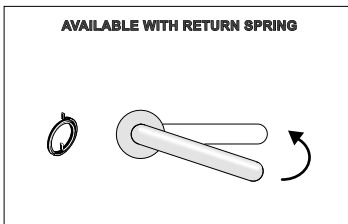

AVAILABLE ON REQUEST AND MINIMUM ORDER

THESE PRODUCTS CONTRIBUTE TO LEED® CREDITS

THE MANUFACTURER RESERVES THE RIGHT TO ALTER, IMPROVE AND DISCONTINUE ANY FEATURES OF THE PRODUCT (MAKE CHANGES AND IMPROVEMENTS IN DESIGNS AND DIMENSIONS) WITHOUT NOTICE.

ALL DIMENSIONS IN THE CATALOG DRAWINGS ARE APPROXIMATIONS. REQUEST THE APPROPRIATE TECHNICAL DRAWING BEFORE DOOR PREPARATION AND INSTALLATION.

FIXING:

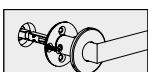

SINGLE SIDE FIXING

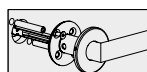

BACK TO BACK FIXING

HANDLE FOR MORTISE
WOOD OR HM DOORS



ITEM THESE PRODUCTS CONTRIBUTE TO **LEED®** CREDITS

YOD.002.0UT8 . xx



with return spring

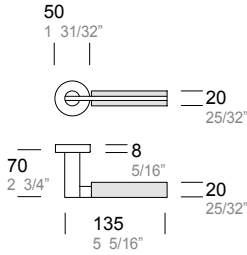

YOD.002.00T4 . xx



without return spring

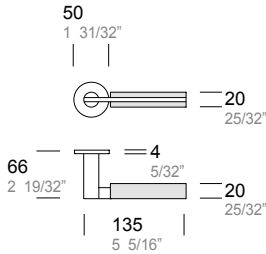

YOD.002.0Uxx . xx



without return spring

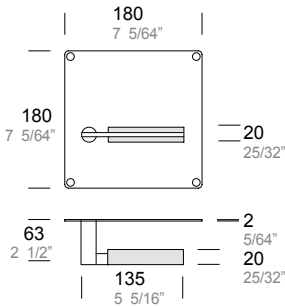

YOD.002.0Uxx . xx



without return spring

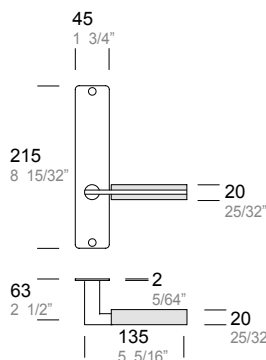

LOCK
WOOD OR HM DOORS

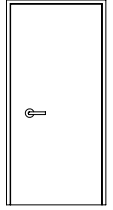
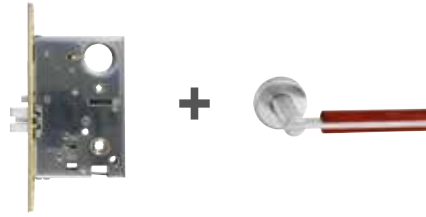

FUNCTION	BACKSET	HOW TO ORDER
PASSAGE ANSI F01	2 1/2" 2 3/4"	2MM.LCK.0A00 . xx + YOD.002.0xTx . xx ONLY LOCK + YOD.002.0Uxx . xx + YOD.002.0Uxx . xx
OFFICE/CORRIDOR ANSI F04	2 1/2" 2 3/4"	2MM.LCK.0F00 . xx + YOD.002.0xTx . xx ONLY LOCK + YOD.002.0Uxx . xx + YOD.002.0Uxx . xx
CLASSROOM ANSI F05	2 1/2" 2 3/4"	2MM.LCK.0G00 . xx + YOD.002.0xTx . xx ONLY LOCK + YOD.002.0Uxx . xx + YOD.002.0Uxx . xx
STOREROOM ANSI F07	2 1/2" 2 3/4"	2MM.LCK.0P00 . xx + YOD.002.0xTx . xx ONLY LOCK + YOD.002.0Uxx . xx + YOD.002.0Uxx . xx
OFFICE/ENTRY ANSI F04 + F13	2 1/2" 2 3/4"	2MM.LCK.0I00 . xx + YOD.002.0xTx . xx ONLY LOCK + YOD.002.0Uxx . xx Add thumbscrews page Levers_127 + YOD.002.0Uxx . xx Add thumbscrews page Levers_127 + YOD.002.0Uxx . xx Add thumbscrews page Levers_127
DORMITORY ANSI F13	2 1/2" 2 3/4"	2MM.LCK.0E00 . xx + YOD.002.0xTx . xx ONLY LOCK + YOD.002.0Uxx . xx Add thumbscrews page Levers_127 + YOD.002.0Uxx . xx Add thumbscrews page Levers_127
PRIVACY ANSI F19	2 1/2" 2 3/4"	2MM.LCK.0M00 . xx + YOD.002.0xTx . xx ONLY LOCK + YOD.002.0Uxx . xx Add thumbscrews page Levers_127 + YOD.002.0Uxx . xx Add thumbscrews page Levers_127

.XX = FINISH CODE

MATT CLEAR COATED WOOD
 .46 WENGÉ
 .49 WENGÉ
 .47 ASH
 .50 ASH
 .48 MAHOGANY
 .51 MAHOGANY

STAINLESS STEEL
 SATIN STAINLESS STEEL (ANSI/BHMA 630 - USD32D)
 BRIGHT STAINLESS STEEL (ANSI/BHMA 629 - USD32)
 SATIN STAINLESS STEEL (ANSI/BHMA 630 - USD32D)
 BRIGHT STAINLESS STEEL (ANSI/BHMA 629 - USD32)
 SATIN STAINLESS STEEL (ANSI/BHMA 630 - USD32D)
 BRIGHT STAINLESS STEEL (ANSI/BHMA 629 - USD32)

PVD ON REQUEST

.83 BLACK SATIN
 Colors on demand, minimum lot to be agreed. Screws and grub screws not pvd

MORTISE LOCKS: SEE TECHNICAL INFORMATION FOR SOLID DOOR SECTION
 MORTISE CYLINDERS NOT INCLUDED see page Levers_141
 FOR COMPATIBLE MODELS

STANDARD FACEPLATE AND STRIKEPLATE SATIN STAINLESS STEEL.

SPINDLE DEPTH, LEVERS POSITION ON THE LOCKSET AND FIXING
 (SINGLE OR BACK TO BACK) MUST BE SPECIFIED ORDERING - see page Levers_142

HANDLE WITH LATCH
WOOD OR HM DOORS



ITEM BACKSET FUNCTION

YOD.002.SA70 . xx	70 mm 2 3/4"	PASSAGE	
YOD.002.SA60 . xx	60 mm 2 3/8"		
latch included			
with return spring			

YOD.002.SB70 . xx	70 mm 2 3/4"	PRIVACY	
YOD.002.SB60 . xx	60 mm 2 3/8"		
latch included			
with return spring			

YOD.002.MA70 . xx	70 mm 2 3/4"	PASSAGE WITH MAGNETIC BOLT	
YOD.002.MA60 . xx	60 mm 2 3/8"		
latch included			
with return spring			

YOD.002.MB70 . xx	70 mm 2 3/4"	PRIVACY WITH MAGNETIC BOLT	
YOD.002.MB60 . xx	60 mm 2 3/8"		
latch included			
with return spring			

.XX = FINISH CODE

- MATT CLEAR COATED WOOD**
- .46 WENGÉ
 - .49 WENGÉ
 - .47 ASH
 - .50 ASH
 - .48 MAHOGANY
 - .51 MAHOGANY

- STAINLESS STEEL**
- SATIN STAINLESS STEEL (ANSI/BHMA 630 - USD32D)
 - BRIGHT STAINLESS STEEL (ANSI/BHMA 629 - USD32)
 - SATIN STAINLESS STEEL (ANSI/BHMA 630 - USD32D)
 - BRIGHT STAINLESS STEEL (ANSI/BHMA 629 - USD32)
 - SATIN STAINLESS STEEL (ANSI/BHMA 630 - USD32D)
 - BRIGHT STAINLESS STEEL (ANSI/BHMA 629 - USD32)

PVD ON REQUEST

- .83 BLACK SATIN
- Colors on demand, minimum lot to be agreed. Screws and grub screws not pvd

HANDLE DUMMY
WOOD OR HM DOORS

THESE PRODUCTS CONTRIBUTE TO LEED® CREDITS



ITEM

YOD.002.0D06 . xx	SINGLE	
YOD.002.C0D6 . xx	PAIR	
dummy		
without return spring		

YOD.002.0D05 . xx	SINGLE	
YOD.002.C0D5 . xx	PAIR	
dummy		
without return spring		



ITEM

STA.004.0UT8.xx

MATERIALS, FINISHING AND DETAILS

.XX = FINISH CODE

STAINLESS STEEL AISI 316L		ALUMINUM	
.4K	SATIN	SILVER	
.4M	SATIN	BRONZE	
.4N	SATIN	BLACK	
.3K	BRIGHT	SILVER	
.3M	BRIGHT	BRONZE	
.3N	BRIGHT	BLACK	

Screws, grub screws and plastic parts non powder-coated.
Available on request depending on quantities.

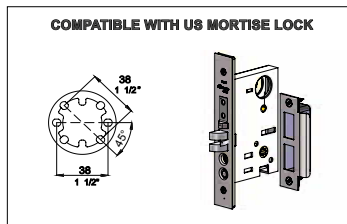
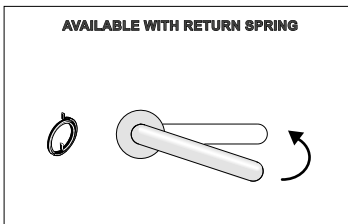

THESE PRODUCTS CONTRIBUTE TO LEED® CREDITS

THE MANUFACTURER RESERVES THE RIGHT TO ALTER, IMPROVE AND DISCONTINUE ANY FEATURES OF THE PRODUCT (MAKE CHANGES AND IMPROVEMENTS IN DESIGNS AND DIMENSIONS) WITHOUT NOTICE.

ALL DIMENSIONS IN THE CATALOG DRAWINGS ARE APPROXIMATIONS. REQUEST THE APPROPRIATE TECHNICAL DRAWING BEFORE DOOR PREPARATION AND INSTALLATION.

FIXING:

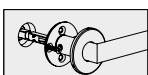

SINGLE SIDE FIXING

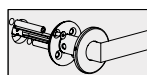

BACK TO BACK FIXING

HANDLE FOR MORTISE
WOOD OR HM DOORS



ITEM THESE PRODUCTS CONTRIBUTE TO LEED® CREDITS

STA.004.0UT8 . xx

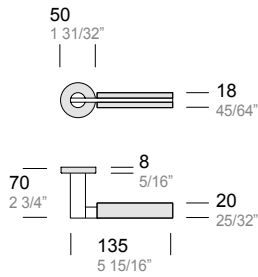

mortise

with return spring

- Stainless Steel
- Aluminium

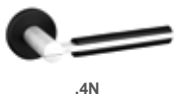
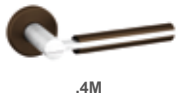

LOCK
WOOD OR HM DOORS

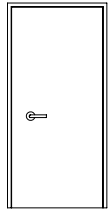
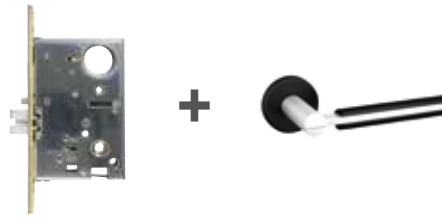

FUNCTION	BACKSET	HOW TO ORDER
PASSAGE ANSI F01	2 1/2" 2 3/4"	2MM.LCK.0A00 . xx + STA.004.0UT8 . xx ONLY LOCK
OFFICE/CORRIDOR ANSI F04	2 1/2" 2 3/4"	2MM.LCK.0F00 . xx + STA.004.0UT8 . xx ONLY LOCK
CLASSROOM ANSI F05	2 1/2" 2 3/4"	2MM.LCK.0G00 . xx + STA.004.0UT8 . xx ONLY LOCK
STOREROOM ANSI F07	2 1/2" 2 3/4"	2MM.LCK.0P00 . xx + STA.004.0UT8 . xx ONLY LOCK
OFFICE/ENTRY ANSI F04 + F13	2 1/2" 2 3/4"	2MM.LCK.0I00 . xx + STA.004.0UT8 . xx ONLY LOCK Add thumbturns page Levers_127
DORMITORY ANSI F13	2 1/2" 2 3/4"	2MM.LCK.0E00 . xx + STA.004.0UT8 . xx ONLY LOCK Add thumbturns page Levers_127
PRIVACY ANSI F19	2 1/2" 2 3/4"	2MM.LCK.0M00 . xx + STA.004.0UT8 . xx ONLY LOCK Add thumbturns page Levers_127

.XX = FINISH CODE

STAINLESS STEEL		ALUMINUM	
.4K	BRIGHT STAINLESS STEEL (ANSI/BHMA 629 - USD32)	SILVER	
.44	BRIGHT STAINLESS STEEL (ANSI/BHMA 629 - USD32)	BRONZE	
.4N	BRIGHT STAINLESS STEEL (ANSI/BHMA 629 - USD32)	BLACK	
.3K	SATIN STAINLESS STEEL (ANSI/BHMA 630 - USD32D)	SILVER	
.34	SATIN STAINLESS STEEL (ANSI/BHMA 630 - USD32D)	BRONZE	
.3N	SATIN STAINLESS STEEL (ANSI/BHMA 630 - USD32D)	BLACK	

MORTISE LOCKS: SEE TECHNICAL INFORMATION FOR SOLID DOOR SECTION
MORTISE CYLINDERS NOT INCLUDED see page Levers_141
FOR COMPATIBLE MODELS

STANDARD FACEPLATE AND STRIKEPLATE SATIN STAINLESS STEEL.

SPINDLE DEPTH, LEVERS POSITION ON THE LOCKSET AND FIXING
(SINGLE OR BACK TO BACK) MUST BE SPECIFIED ORDERING - see page Levers_143



ITEM

STA.005.0UT8.xx

MATERIALS, FINISHING AND DETAILS

.XX = FINISH CODE

	STAINLESS STEEL AISI 316L	ALUMINUM	
.4K	SATIN	SILVER	
.4M	SATIN	BRONZE	
.4N	SATIN	BLACK	
.3K	BRIGHT	SILVER	
.3M	BRIGHT	BRONZE	
.3N	BRIGHT	BLACK	

Screws, grub screws and plastic parts non powder-coated.
Available on request depending on quantities.

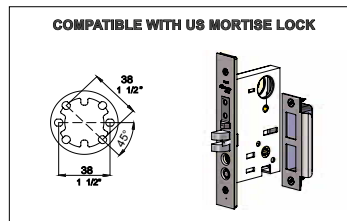

THESE PRODUCTS CONTRIBUTE TO LEED® CREDITS

THE MANUFACTURER RESERVES THE RIGHT TO ALTER, IMPROVE AND DISCONTINUE ANY FEATURES OF THE PRODUCT (MAKE CHANGES AND IMPROVEMENTS IN DESIGNS AND DIMENSIONS) WITHOUT NOTICE.

ALL DIMENSIONS IN THE CATALOG DRAWINGS ARE APPROXIMATIONS. REQUEST THE APPROPRIATE TECHNICAL DRAWING BEFORE DOOR PREPARATION AND INSTALLATION.

FIXING:

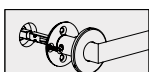

SINGLE SIDE FIXING

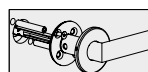

BACK TO BACK FIXING

HANDLE FOR MORTISE
WOOD OR HM DOORS



ITEM THESE PRODUCTS CONTRIBUTE TO LEED® CREDITS

STA.005.0UT8 . xx

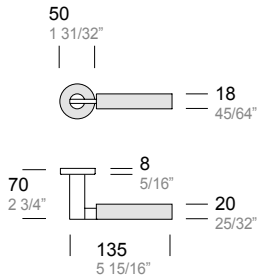

mortise

with return spring

- Stainless Steel
- Aluminium



.4K



.4M



.4N

LOCK
WOOD OR HM DOORS

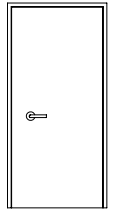

FUNCTION	BACKSET	HOW TO ORDER
PASSAGE ANSI F01	2 1/2" 2 3/4"	2MM.LCK.0A00 . xx + STA.005.0UT8 . xx ONLY LOCK
OFFICE/CORRIDOR ANSI F04	2 1/2" 2 3/4"	2MM.LCK.0F00 . xx + STA.005.0UT8 . xx ONLY LOCK
CLASSROOM ANSI F05	2 1/2" 2 3/4"	2MM.LCK.0G00 . xx + STA.005.0UT8 . xx ONLY LOCK
STOREROOM ANSI F07	2 1/2" 2 3/4"	2MM.LCK.0P00 . xx + STA.005.0UT8 . xx ONLY LOCK
OFFICE/ENTRY ANSI F04 + F13	2 1/2" 2 3/4"	2MM.LCK.0I00 . xx + STA.005.0UT8 . xx ONLY LOCK Add thumbturns page Levers_127
DORMITORY ANSI F13	2 1/2" 2 3/4"	2MM.LCK.0E00 . xx + STA.005.0UT8 . xx ONLY LOCK Add thumbturns page Levers_127
PRIVACY ANSI F19	2 1/2" 2 3/4"	2MM.LCK.0M00 . xx + STA.005.0UT8 . xx ONLY LOCK Add thumbturns page Levers_127

.XX = FINISH CODE

STAINLESS STEEL		ALUMINUM	
.4K	BRIGHT STAINLESS STEEL (ANSI/BHMA 629 - USD32)	SILVER	
.44	BRIGHT STAINLESS STEEL (ANSI/BHMA 629 - USD32)	BRONZE	
.4N	BRIGHT STAINLESS STEEL (ANSI/BHMA 629 - USD32)	BLACK	
.3K	SATIN STAINLESS STEEL (ANSI/BHMA 630 - USD32D)	SILVER	
.34	SATIN STAINLESS STEEL (ANSI/BHMA 630 - USD32D)	BRONZE	
.3N	SATIN STAINLESS STEEL (ANSI/BHMA 630 - USD32D)	BLACK	

MORTISE LOCKS: SEE TECHNICAL INFORMATION FOR SOLID DOOR SECTION
MORTISE CYLINDERS NOT INCLUDED see page Levers_141
FOR COMPATIBLE MODELS

STANDARD FACEPLATE AND STRIKEPLATE SATIN STAINLESS STEEL.

SPINDLE DEPTH, LEVERS POSITION ON THE LOCKSET AND FIXING
(SINGLE OR BACK TO BACK) MUST BE SPECIFIED ORDERING - see page Levers_143



ITEM

STA.006.0UT8.xx

MATERIALS, FINISHING AND DETAILS

.XX = FINISH CODE

STAINLESS STEEL AISI 316L		ALUMINUM	
.4K	SATIN	SILVER	
.4M	SATIN	BRONZE	
.4N	SATIN	BLACK	
.3K	BRIGHT	SILVER	
.3M	BRIGHT	BRONZE	
.3N	BRIGHT	BLACK	

Screws, grub screws and plastic parts non powder-coated.
Available on request depending on quantities.

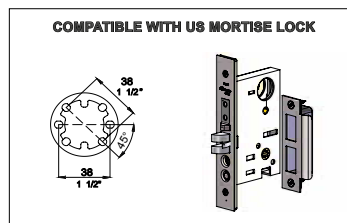
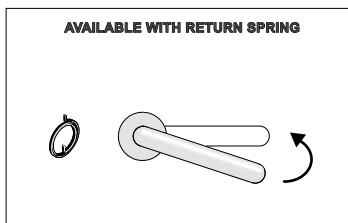

THESE PRODUCTS CONTRIBUTE TO **LEED®** CREDITS

THE MANUFACTURER RESERVES THE RIGHT TO ALTER, IMPROVE AND DISCONTINUE ANY FEATURES OF THE PRODUCT (MAKE CHANGES AND IMPROVEMENTS IN DESIGNS AND DIMENSIONS) WITHOUT NOTICE.

ALL DIMENSIONS IN THE CATALOG DRAWINGS ARE APPROXIMATIONS. REQUEST THE APPROPRIATE TECHNICAL DRAWING BEFORE DOOR PREPARATION AND INSTALLATION.

FIXING:

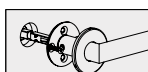

SINGLE SIDE FIXING

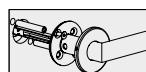

BACK TO BACK FIXING

HANDLE FOR MORTISE
WOOD OR HM DOORS



ITEM THESE PRODUCTS CONTRIBUTE TO LEED® CREDITS

STA.006.0UT8 . xx

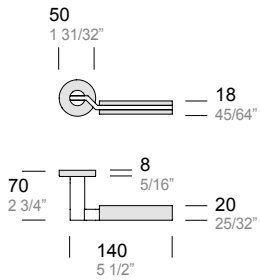
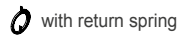

- Stainless Steel
- Aluminium



LOCK
WOOD OR HM DOORS

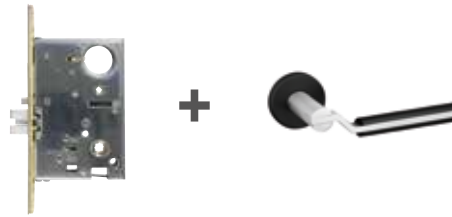

FUNCTION	BACKSET	HOW TO ORDER
PASSAGE ANSI F01	2 1/2" 2 3/4"	2MM.LCK.0A00 . xx + STA.006.0UT8 . xx ONLY LOCK
OFFICE/CORRIDOR ANSI F04	2 1/2" 2 3/4"	2MM.LCK.0F00 . xx + STA.006.0UT8 . xx ONLY LOCK
CLASSROOM ANSI F05	2 1/2" 2 3/4"	2MM.LCK.0G00 . xx + STA.006.0UT8 . xx ONLY LOCK
STOREROOM ANSI F07	2 1/2" 2 3/4"	2MM.LCK.0P00 . xx + STA.006.0UT8 . xx ONLY LOCK
OFFICE/ENTRY ANSI F04 + F13	2 1/2" 2 3/4"	2MM.LCK.0I00 . xx + STA.006.0UT8 . xx ONLY LOCK Add thumbturns page Levers_127
DORMITORY ANSI F13	2 1/2" 2 3/4"	2MM.LCK.0E00 . xx + STA.006.0UT8 . xx ONLY LOCK Add thumbturns page Levers_127
PRIVACY ANSI F19	2 1/2" 2 3/4"	2MM.LCK.0M00 . xx + STA.006.0UT8 . xx ONLY LOCK Add thumbturns page Levers_127

.XX = FINISH CODE

STAINLESS STEEL		ALUMINUM	
.4K	BRIGHT STAINLESS STEEL (ANSI/BHMA 629 - USD32)	SILVER	
.44	BRIGHT STAINLESS STEEL (ANSI/BHMA 629 - USD32)	BRONZE	
.4N	BRIGHT STAINLESS STEEL (ANSI/BHMA 629 - USD32)	BLACK	
.3K	SATIN STAINLESS STEEL (ANSI/BHMA 630 - USD32D)	SILVER	
.34	SATIN STAINLESS STEEL (ANSI/BHMA 630 - USD32D)	BRONZE	
.3N	SATIN STAINLESS STEEL (ANSI/BHMA 630 - USD32D)	BLACK	

MORTISE LOCKS: SEE TECHNICAL INFORMATION FOR SOLID DOOR SECTION

MORTISE CYLINDERS NOT INCLUDED see page Levers_141
FOR COMPATIBLE MODELS

STANDARD FACEPLATE AND STRIKEPLATE SATIN STAINLESS STEEL.

SPINDLE DEPTH, LEVERS POSITION ON THE LOCKSET AND FIXING
(SINGLE OR BACK TO BACK) MUST BE SPECIFIED ORDERING - see page Levers_143

THUMBTURNS



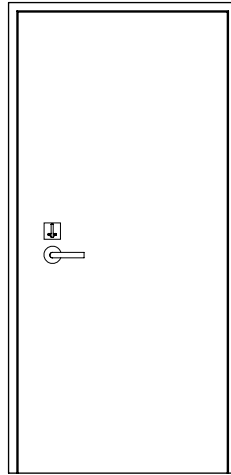
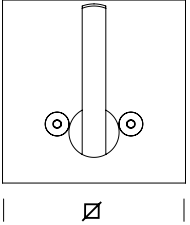
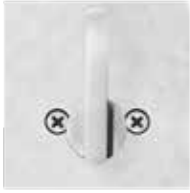

HANDLE NOT INCLUDED

ITEM WITH LATCH



BACKSET

FUNCTION

2MM.037.0L70. xx

62 mm
2 7/16"

70 mm
2 3/4"

KEY RING / THUMB-TURN

2MM.037.0L60. xx

62 mm
2 7/16"

60 mm
2 3/8"

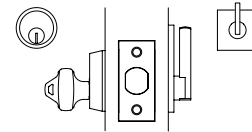
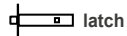

* 2MM.037.0H70. xx

62 mm
2 7/16"

70 mm
2 3/4"

PRIVACY INDICATOR WITH
EMERGENCY COIN RELEASE /
THUMB-TURN

* 2MM.037.0H60. xx

62 mm
2 7/16"

60 mm
2 3/8"

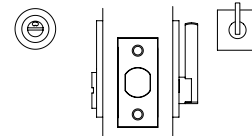
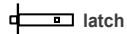

2MM.037.0B70. xx

62 mm
2 7/16"

70 mm
2 3/4"

THUMB-TURN

2MM.037.0B60. xx

62 mm
2 7/16"

60 mm
2 3/8"

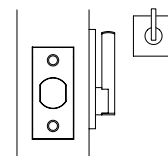
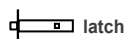

.XX = FINISH CODE

STAINLESS STEEL

- .43 BRIGHT STAINLESS STEEL (ANSI/BHMA 629 - USD32)
- .44 SATIN STAINLESS STEEL (ANSI/BHMA 630 - USD32D)

PVD ON REQUEST

- .83 BLACK SATIN
- Colors on demand, minimum lot to be agreed.
- Screws and grub screws not pvd

STAINLESS STEEL POWDER-COATED ON REQUEST

- .40 BLACK RAL 9005 MATT - TO MATCH WITH PBA BLACK ALUMINUM
- .26 BLACK RAL 9005 GLOSSY
- .31 WHITE RAL 9010
- .32 GREY
- .38 CHAMPAGNE
- .39 BRONZE - TO MATCH WITH PBA BRONZE ALUMINUM
- .36 ARCHITECTURAL BRONZE
- .56 MEDIUM BRONZE
- .41 SILVER
- .55 GOLD

- .99 COLORS ON REQUEST TO MATCH ANY RAL #
(screws, grub screws and plastic parts non powder-coated)
available on request depending on quantities

* PRIVACY INDICATOR WITH EMERGENCY COIN RELEASE

THESE PRODUCTS CONTRIBUTE TO LEED® CREDITS

THUMBTURNS FOR MORTISE
WOOD OR HM DOORS

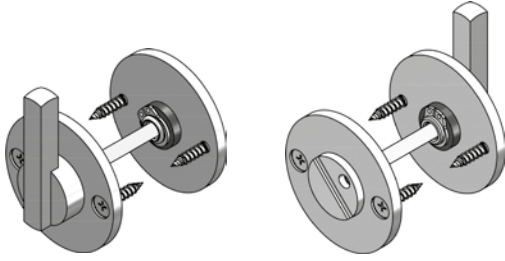

ITEM

2MM.035.0UT4 . xx

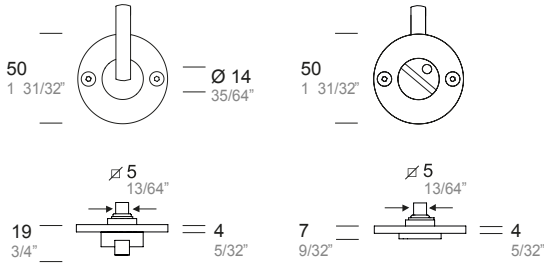

2MM.035.0050 . xx

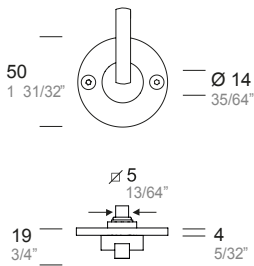

LOCK
WOOD OR HM DOORS

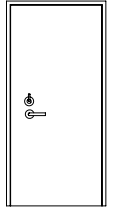
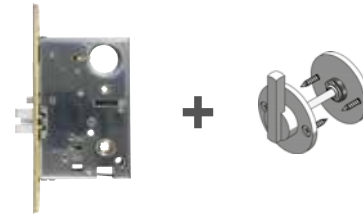

HANDLE
NOT
INCLUDED

FUNCTION

BACKSET

HOW TO ORDER

PRIVACY
ANSI F19

2 1/2"
2 3/4"

2MM.LCK.0M00 . xx
+ 2MM.035.0UT4 . xx

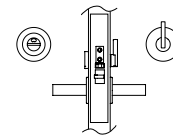

OFFICE/ENTRY
ANSI F04 + F13

2 1/2"
2 3/4"

2MM.LCK.0100 . xx
+ 2MM.035.0050 . xx

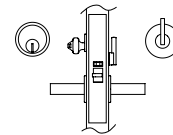

DORMITORY
ANSI F13

2 1/2"
2 3/4"

2MM.LCK.0E00 . xx
+ 2MM.035.0050 . xx

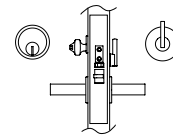

.XX = FINISH CODE

STAINLESS STEEL

- .43 BRIGHT STAINLESS STEEL (ANSI/BHMA 629 - USD32)
- .44 SATIN STAINLESS STEEL (ANSI/BHMA 630 - USD32D)

PVD ON REQUEST

- .83 BLACK SATIN
- Colors on demand, minimum lot to be agreed.
- Screws and grub screws not pvd

STAINLESS STEEL POWDER-COATED ON REQUEST

- .40 BLACK RAL 9005 MATT - TO MATCH WITH PBA BLACK ALUMINUM
- .26 BLACK RAL 9005 GLOSSY
- .31 WHITE RAL 9010
- .32 GREY
- .38 CHAMPAGNE
- .39 BRONZE - TO MATCH WITH PBA BRONZE ALUMINUM
- .36 ARCHITECTURAL BRONZE
- .56 MEDIUM BRONZE
- .41 SILVER
- .55 GOLD

- .99 COLORS ON REQUEST TO MATCH ANY RAL #
(screws, grub screws and plastic parts non powder-coated)
available on request depending on quantities

AVAILABLE LOCKS
page Levers_138

THESE PRODUCTS CONTRIBUTE TO LEED® CREDITS

THUMBTURNS FOR MORTISE
WOOD OR HM DOORS



ITEM

2MM.035.0U08 . xx

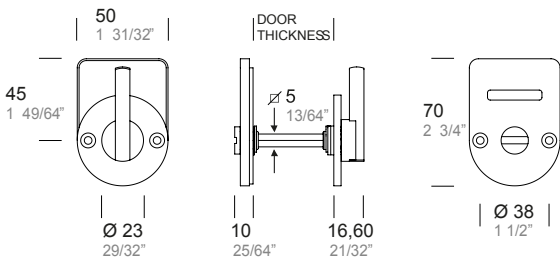

ITEM

2MM.35S.0U08 . xx

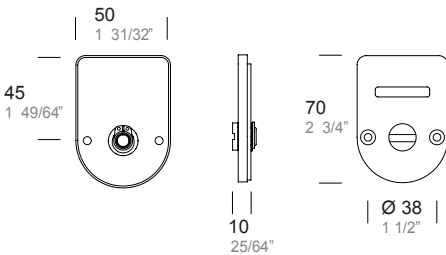

.XX = FINISH CODE

- STAINLESS STEEL**
 .43 BRIGHT STAINLESS STEEL (ANSI/BHMA 629 - USD32)
 .44 SATIN STAINLESS STEEL (ANSI/BHMA 630 - USD32D)

- PVD ON REQUEST**
 .83 BLACK SATIN
 Colors on demand, minimum lot to be agreed.
 Screws and grub screws not pvd

- STAINLESS STEEL POWDER-COATED ON REQUEST**
 .40 BLACK RAL 9005 MATT - TO MATCH WITH PBA BLACK ALUMINUM
 .26 BLACK RAL 9005 GLOSSY
 .31 WHITE RAL 9010
 .32 GREY
 .38 CHAMPAGNE
 .39 BRONZE - TO MATCH WITH PBA BRONZE ALUMINUM
 .36 ARCHITECTURAL BRONZE
 .56 MEDIUM BRONZE
 .41 SILVER
 .55 GOLD

- .99 COLORS ON REQUEST TO MATCH ANY RAL #
 (screws, grub screws and plastic parts non powder-coated)
 available on request depending on quantities

AVAILABLE LOCKS
 page Levers_138

THESE PRODUCTS CONTRIBUTE TO LEED® CREDITS

LOCK
WOOD OR HM DOORS

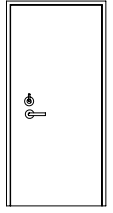

HANDLE
NOT
INCLUDED

FUNCTION

BACKSET

HOW TO ORDER

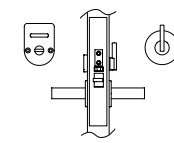

2 1/2"
2 3/4"

2MM.LCK.0M00 . xx
+ 2MM.035.0U08 . xx

THUMBTURNS FOR MORTISE
WOOD OR HM DOORS

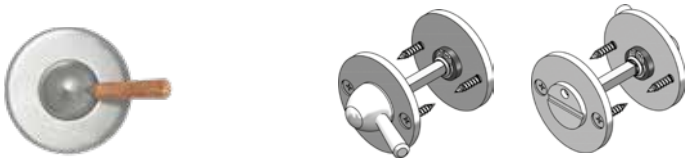

ITEM

2MU.033.0UT4 .4R

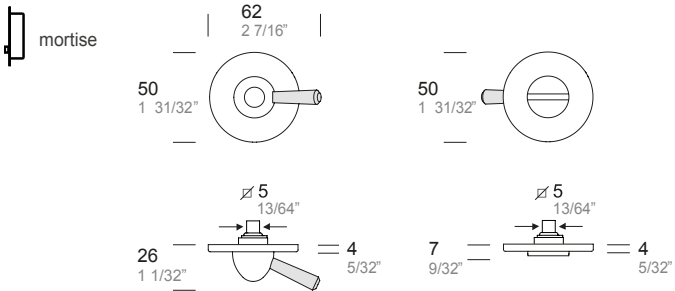

2MU.033.0050 .4R

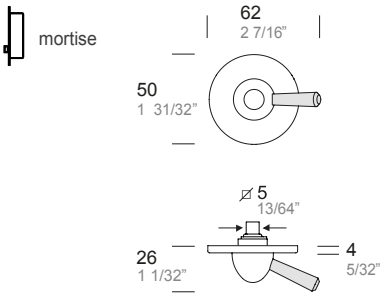

- Stainless Steel
- Satin Copper

FINISH CODE
COPPER
 .4R SATIN COPPER
STAINLESS STEEL
 SATIN STAINLESS STEEL (ANSI/BHMA 630 - USD32D)

US MORTISE LOCKS
WOOD OR HM DOORS

ANTIMICROBIAL
COPPER

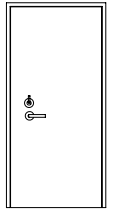

HANDLE
NOT
INCLUDED

FUNCTION

BACKSET

HOW TO ORDER

PRIVACY
ANSI F19

2 1/2"
2 3/4"

2MM.LCK.0M00 . xx
+ 2MU.033.0UT4 .4R

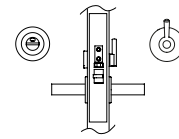

OFFICE/ENTRY
ANSI F04 + F13

2 1/2"
2 3/4"

2MM.LCK.0100 . xx
+ 2MU.033.0050 .4R

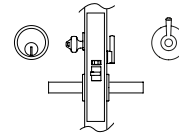

DORMITORY
ANSI F13

2 1/2"
2 3/4"

2MM.LCK.0E00 . xx
+ 2MU.033.0050 .4R

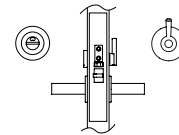

AVAILABLE LOCKS
page Levers_138



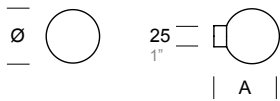

ITEM	Ø	A
☒ 2MM.090.000F . xx	65 2 9/16"	78 3 1/16"
2MM.091.000F . xx	50 1 31/32"	63 2 1/2"

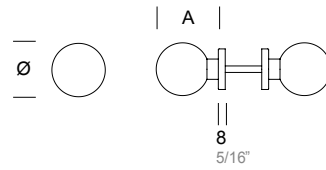

ITEM	Ø	A
☒ 2MM.090.000G . xx	65 2 9/16"	85 3 11/32"
☒ 2MM.091.000G . xx	50 1 31/32"	70 2 3/4"

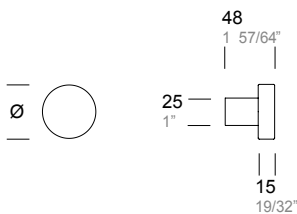

ITEM	Ø
☒ 2MM.092.000F . xx	50 1 31/32"

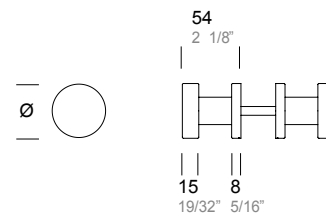

ITEM	Ø
☒ 2MM.092.000G	50 1 31/32"

.XX = FINISH CODE

STAINLESS STEEL

- .43 BRIGHT STAINLESS STEEL (ANSI/BHMA 629 - USD32)
- .44 SATIN STAINLESS STEEL (ANSI/BHMA 630 - USD32D)

PVD ON REQUEST

- .83 BLACK SATIN
- Colors on demand, minimum lot to be agreed.
- Screws and grub screws not pvd

STAINLESS STEEL POWDER-COATED ON REQUEST

- .40 BLACK RAL 9005 MATT - TO MATCH WITH PBA BLACK ALUMINUM
- .26 BLACK RAL 9005 GLOSSY
- .31 WHITE RAL 9010
- .32 GREY
- .38 CHAMPAGNE
- .39 BRONZE - TO MATCH WITH PBA BRONZE ALUMINUM
- .36 ARCHITECTURAL BRONZE
- .56 MEDIUM BRONZE
- .41 SILVER
- .55 GOLD

- .99 COLORS ON REQUEST TO MATCH ANY RAL #
(screws, grub screws and plastic parts non powder-coated)
available on request depending on quantities

THESE PRODUCTS CONTRIBUTE TO LEED® CREDITS



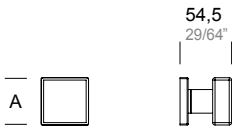

ITEM	A
XX 2MM.094.000F . xx	50 1 31/32"

.XX = FINISH CODE

- STAINLESS STEEL**
 .43 BRIGHT STAINLESS STEEL (ANSI/BHMA 629 - USD32)
 .44 SATIN STAINLESS STEEL (ANSI/BHMA 630 - USD32D)

- PVD ON REQUEST**
 .83 BLACK SATIN
 Colors on demand, minimum lot to be agreed.
 Screws and grub screws not pvd

STAINLESS STEEL POWDER-COATED ON REQUEST

- .40 BLACK RAL 9005 MATT - TO MATCH WITH PBA BLACK ALUMINUM
 .26 BLACK RAL 9005 GLOSSY
 .31 WHITE RAL 9010
 .32 GREY
 .38 CHAMPAGNE
 .39 BRONZE - TO MATCH WITH PBA BRONZE ALUMINUM
 .36 ARCHITECTURAL BRONZE
 .56 MEDIUM BRONZE
 .41 SILVER
 .55 GOLD

- .99 COLORS ON REQUEST TO MATCH ANY RAL #
 (screws, grub screws and plastic parts non powder-coated)
 available on request depending on quantities

THESE PRODUCTS CONTRIBUTE TO LEED® CREDITS



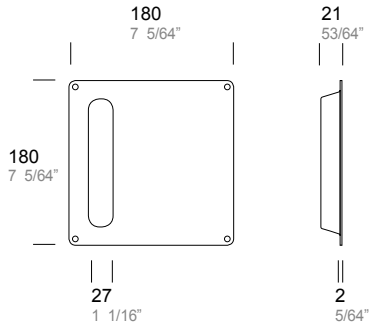

ITEM

- .xx
- 2MM.301.0000

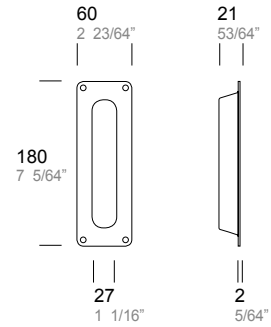

ITEM

- .xx
- 2MM.302.0000

.XX = FINISH CODE

- STAINLESS STEEL
- .43 BRIGHT STAINLESS STEEL (ANSI/BHMA 629 - USD32)
- .44 SATIN STAINLESS STEEL (ANSI/BHMA 630 - USD32D)
- PVD ON REQUEST
- .83 BLACK SATIN
Colors on demand, minimum lot to be agreed.
Screws and grub screws not pvd
- POWDER-COATED FINISH NOT AVAILABLE

STAINLESS STEEL POWDER-COATED ON REQUEST

- .40 BLACK RAL 9005 MATT - TO MATCH WITH PBA BLACK ALUMINUM
- .26 BLACK RAL 9005 GLOSSY
- .31 WHITE RAL 9010
- .32 GREY
- .38 CHAMPAGNE
- .39 BRONZE - TO MATCH WITH PBA BRONZE ALUMINUM
- .36 ARCHITECTURAL BRONZE
- .56 MEDIUM BRONZE
- .41 SILVER
- .55 GOLD

- .99 COLORS ON REQUEST TO MATCH ANY RAL #
(screws, grub screws and plastic parts non powder-coated)
available on request depending on quantities

THESE PRODUCTS CONTRIBUTE TO LEED® CREDITS



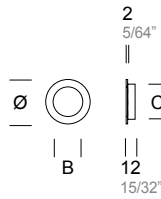

ITEM	Ø	B	C
○ 2MM.305.0000 .xx	46 1 13/16"	30,5 1 3/16"	34 1 11/32"
○ 2MM.306.0000 .xx	60 2 23/64"	42,5 1 43/64"	48 1 57/64"

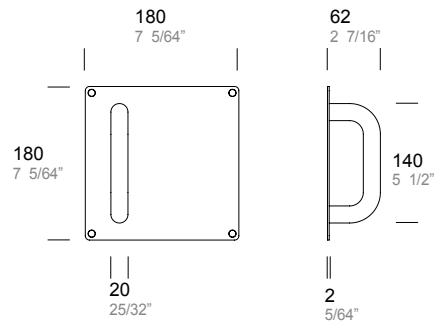

ITEM
2MM.201.0000 .xx

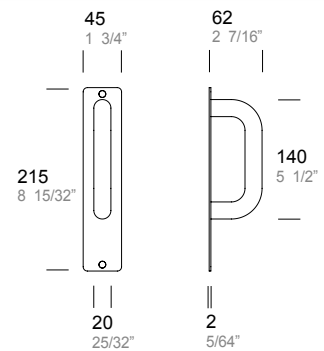

ITEM
○ 2MM.211.0000 .xx
○ 2MM.212.0000 .xx
○ 2MM.213.0000 .xx
○ 2MM.214.0000 .xx
○ 2MM.215.0000 .xx

.XX = FINISH CODE

- .43 STAINLESS STEEL
- .43 BRIGHT STAINLESS STEEL (ANSI/BHMA 629 - USD32)
- .44 SATIN STAINLESS STEEL (ANSI/BHMA 630 - USD32D)
- PVD ON REQUEST
- .83 BLACK SATIN
Colors on demand, minimum lot to be agreed.
Screws and grub screws not pvd
- POWDER-COATED FINISH NOT AVAILABLE

- STAINLESS STEEL POWDER-COATED ON REQUEST
- .40 BLACK RAL 9005 MATT - TO MATCH WITH PBA BLACK ALUMINUM
- .26 BLACK RAL 9005 GLOSSY
- .31 WHITE RAL 9010
- .32 GREY
- .38 CHAMPAGNE
- .39 BRONZE - TO MATCH WITH PBA BRONZE ALUMINUM
- .36 ARCHITECTURAL BRONZE
- .56 MEDIUM BRONZE
- .41 SILVER
- .55 GOLD

- .99 COLORS ON REQUEST TO MATCH ANY RAL #
(screws, grub screws and plastic parts non powder-coated)
available on request depending on quantities

THESE PRODUCTS CONTRIBUTE TO LEED® CREDITS



TECHNICAL INFORMATION

MORTISE LOCKS for WOOD OR METAL DOORS

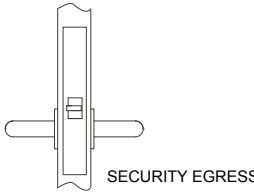
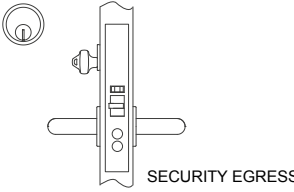
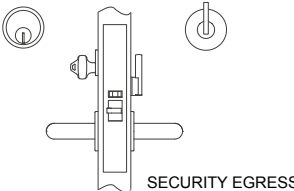
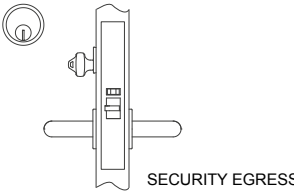
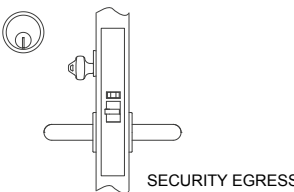
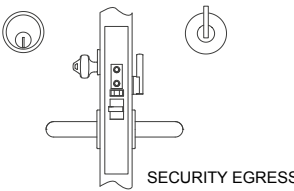
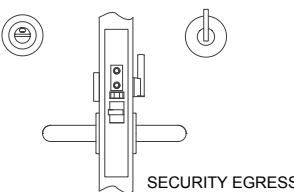
ANSI CODE - FUNCTION PBA CODE*	<div style="display: flex; justify-content: space-around; align-items: center;"> OUTSIDE  INSIDE </div>	OPERATION
<p>F01 - PASSAGE 2MM.LCK.0A00.00 - backset 2 1/2" **</p>	 <p style="text-align: center;">SECURITY EGRESS</p>	<p>LATCHBOLT OPERATED BY LEVER FROM EITHER SIDE AT ALL TIMES</p>
<p>F04 - OFFICE / CORRIDOR 2MM.LCK.0F00.00 - backset 2 1/2" **</p>	 <p style="text-align: center;">SECURITY EGRESS</p>	<p>LATCHBOLT OPERATED BY LEVER FROM EITHER SIDE, EXCEPT WHEN OUTSIDE LEVER IS LOCKED BY STOP BUTTONS. UNLOCK BY KEY OUTSIDE OR LEVER INSIDE.</p>
<p>F04 + F13 - OFFICE / ENTRY 2MM.LCK.0I00.00 - backset 2 1/2" **</p>	 <p style="text-align: center;">SECURITY EGRESS</p>	<p>LATCHBOLT OPERATED BY LEVER FROM EITHER SIDE, EXCEPT WHEN OUTSIDE LEVER IS LOCKED BY KEY OR THUMBTURN FROM INSIDE. UNLOCK BY KEY OUTSIDE OR THUMBTURN / LEVER FROM INSIDE.</p>
<p>F05 - CLASSROOM 2MM.LCK.0G00.00 - backset 2 1/2" **</p>	 <p style="text-align: center;">SECURITY EGRESS</p>	<p>LATCHBOLT OPERATED BY LEVER FROM EITHER SIDE, EXCEPT WHEN OUTSIDE LEVER IS LOCKED BY OUTSIDE KEY. UNLOCK BY KEY OUTSIDE OR LEVER INSIDE.</p>
<p>F07 - STOREROOM 2MM.LCK.0P00.00 - backset 2 1/2" **</p>	 <p style="text-align: center;">SECURITY EGRESS</p>	<p>LATCHBOLT OPERATED BY KEY OUTSIDE OR BY OPERATING LEVER INSIDE. OUTSIDE LEVER IS ALWAYS INOPERATIVE.</p>
<p>F13 - DORMITORY 2MM.LCK.0E00.00 - backset 2 1/2" **</p>	 <p style="text-align: center;">SECURITY EGRESS</p>	<p>LATCHBOLT OPERATED BY LEVER FROM EITHER SIDE, EXCEPT WHEN OUTSIDE LEVER IS LOCKED BY KEY OR THUMBTURN FROM INSIDE AND THE DEADBOLT IS PROJECTED. UNLOCK BY KEY OUTSIDE OR THUMBTURN OR LEVER FROM INSIDE WHICH RETRACT BOTH BOLTS SIMULTANEOUSLY.</p>
<p>F19 - PRIVACY 2MM.LCK.0M00.00 - backset 2 1/2" **</p>	 <p style="text-align: center;">SECURITY EGRESS</p>	<p>LATCHBOLT OPERATED BY LEVER FROM EITHER SIDE, EXCEPT WHEN OUTSIDE LEVER IS LOCKED BY INSIDE THUMBTURN AND THE DEADBOLT IS PROJECTED. UNLOCK BY KEY OUTSIDE OR LEVER FROM INSIDE WHICH RETRACT BOTH BOLTS SIMULTANEOUSLY.</p>



STAINLESS STEEL FACEPLATE INCLUDED



STAINLESS STEEL STRIKE PLATE INCLUDED

* Lever handles, thumbturns and cylinders not included ** Backset 2 3/4" available on request

MORTISE LOCK

PBA 2MM.LCK SERIES MORTISE LOCKS FOR SOLID DOORS ARE ENGINEERED FOR DURABILITY AND OPTIMUM SECURITY. ALL LOCK CASES ARE CONSTRUCTED WITH QUALITY METAL WORKING PARTS, ENSURING THE LONG LASTING AND TROUBLE FREE OPERATION.

GRADE 1 ACCORDINGLY TO ANSI/BHMA 156.13 - 2005 AND UL – ULC LISTED THE 2MM.LCK MORTISE LOCKS CAN BE SPECIFIED FOR APPLICATION IN RESIDENTIAL, OFFICES, HOTELS, SCHOOLS AND COMMERCIAL BUILDINGS

AVAILABLE IN SEVEN DIFFERENT FUNCTIONS AND WITH TWO BACKSET (2 ½" AND 2 ¾") THE 2MM.LCK MORTISE LOCKS ARE EQUIPPED WITH A MECHANICAL ANTI-FRICTION LATCH BOLT AND A FULL 1" THROW DEADBOLT WITH TWO HARDENED STEEL ROLLERS FOR MAXIMUM SECURITY.

THE EXPOSED PARTS (DEADBOLT, LATCH BOLT, AUXILIARY LATCH AND BUTTONS) ARE IN FORGED BRASS AND FINISHED TO MATCH THE APPEARANCE OF THE STAINLESS STEEL FACEPLATE.

THE FIELD-REVERSIBLE DESIGN ALLOWS TO SWITCH HANDING ON SITE, WITHOUT OPENING THE LOCK CASE. 2MM.LCK MORTISE LOCKS FEATURE AN INDEPENDENT LEVER ROTATION.

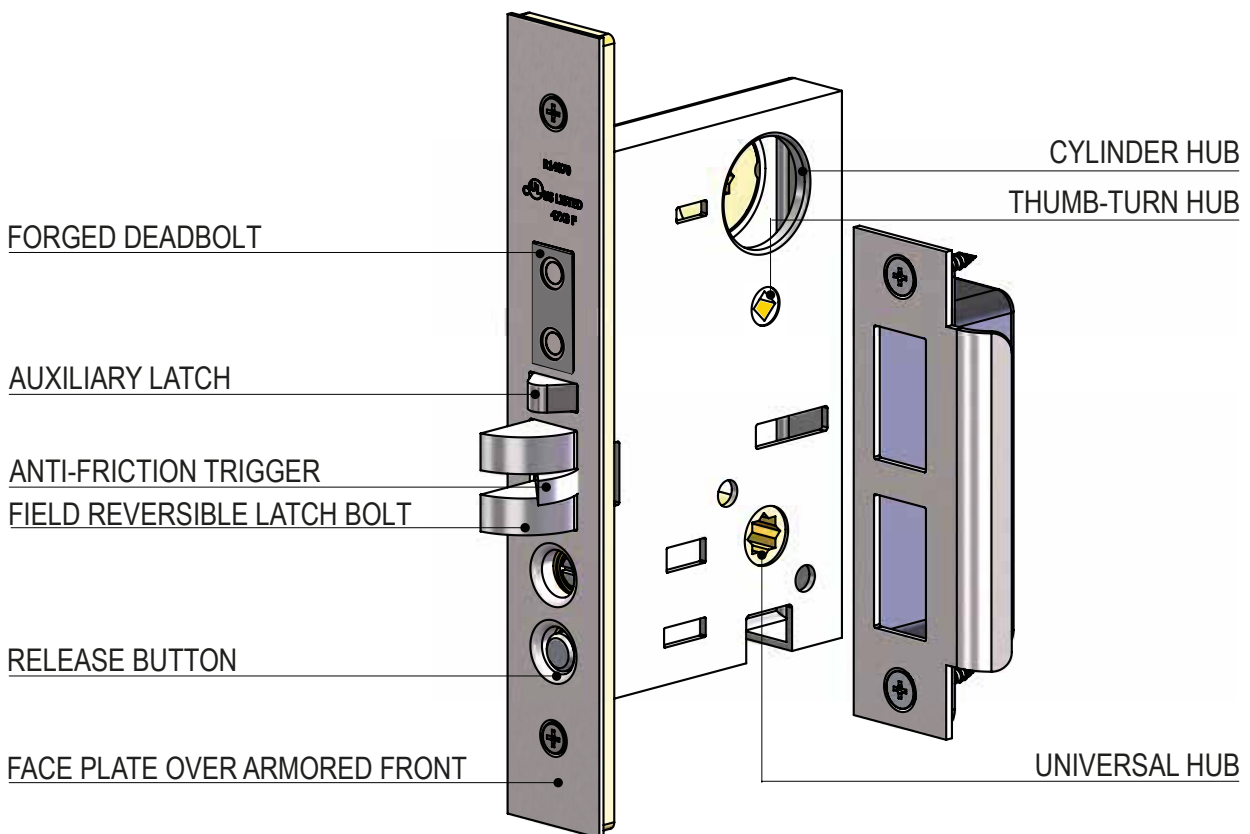

TECH SPECS

BACKSET 2 1/2

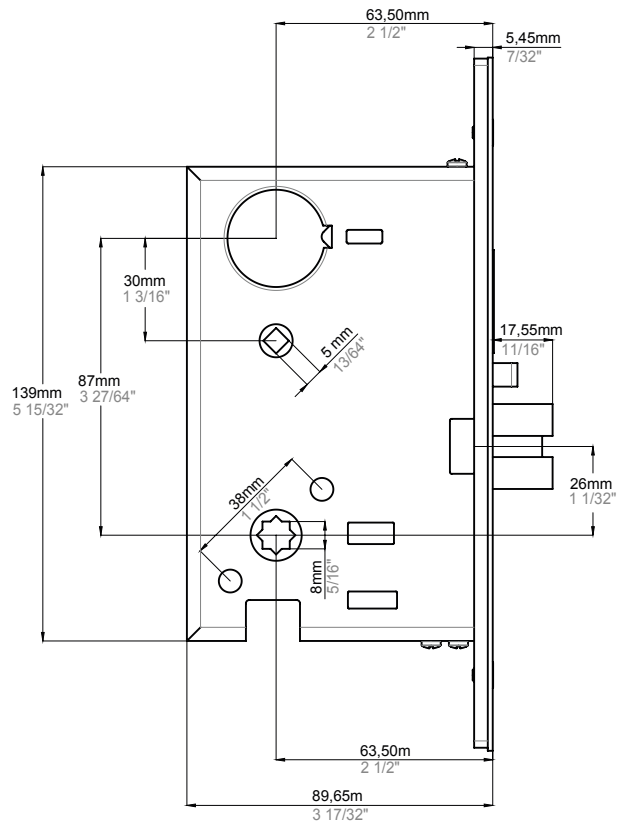
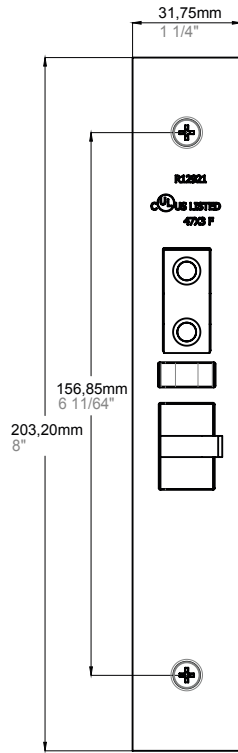

BACKSET 2 3/4

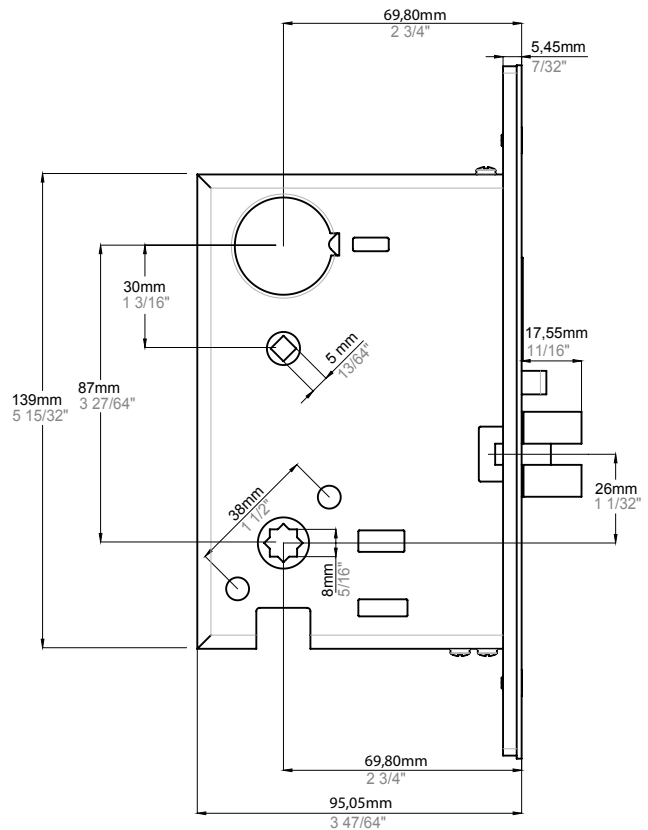
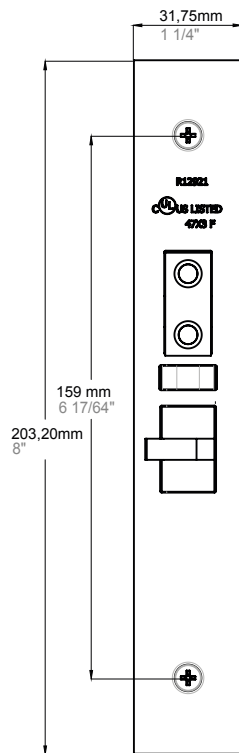

AVAILABLE FORMATS:

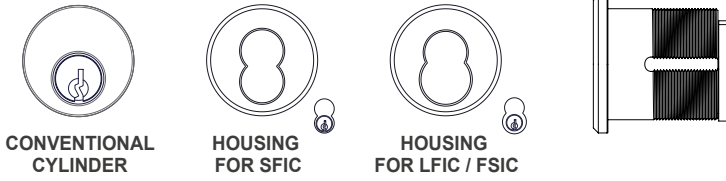

PBA MORTISE LOCKS CAN WORK WITH EVERY BRAND OR MODEL OF MORTISE CYLINDERS WITH THE FOLLOWING CAMS INSTALLED:



MORTISE CONVENTIONAL CYLINDER

CIL.MOR.0001.00
MORTISE CONVENTIONAL CYLINDER BATON L=15/16" WITH YA CAM

OTHER BRANDS AVAILABLE ON REQUEST:
ARROW - CORBIN RUSSWIN - KABA - ILCO - MEDECO - SCHLAGE - SARGENT - YALE



MORTISE HOUSING FOR IC

AVAILABLE ON REQUEST MORTISE HOUSINGS FOR SFIC - LFIC / FSIC OF THE FOLLOWING BRANDS:
ARROW - CORBIN RUSSWIN - KABA - ILCO - MEDECO - SCHLAGE - SARGENT - YALE

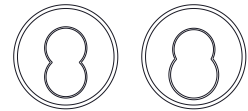

CORE FOR SFIC HOUSING AND LFIC / FSIC HOUSING

AVAILABLE ON REQUEST SFIC - LFIC / FSIC CORES OF THE FOLLOWING BRANDS:
ARROW - CORBIN RUSSWIN - KABA - ILCO - MEDECO - SCHLAGE - SARGENT - YALE

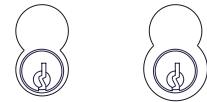

DIGITAL MORTISE CYLINDER WITH CARD AVAILABLE ON REQUEST

SUGGESTED BRAND:
SALTO Neo
SALTO Geo



SPECIAL APPLICATION WITH KEY SYSTEM ON REQUEST

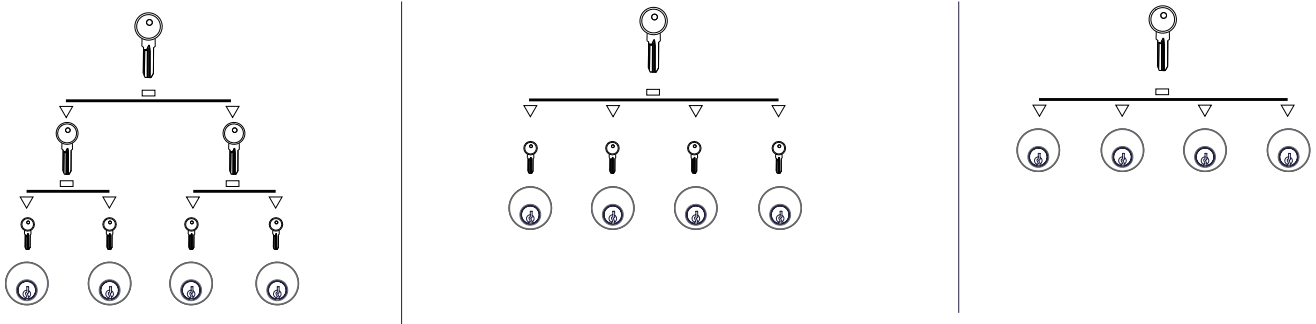

SINGLE CYLINDER INSTALLATION

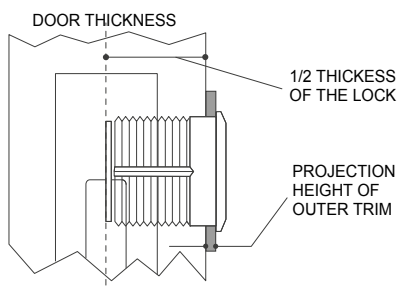

DOUBLE CYLINDERS INSTALLATION

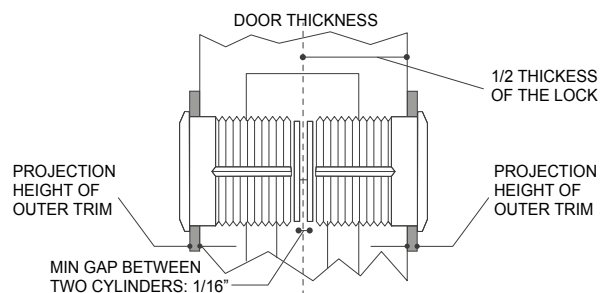

COMPATIBILITY WITH LOCKS

2MM.LCK - US MORTISE LOCK

BTB FIXING
METRIC SCREWS + BUSHING

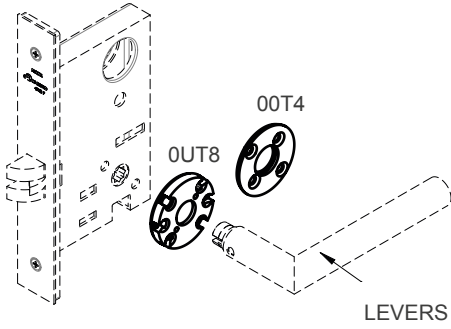

SINGLE FIXING
WOOD SCREWS

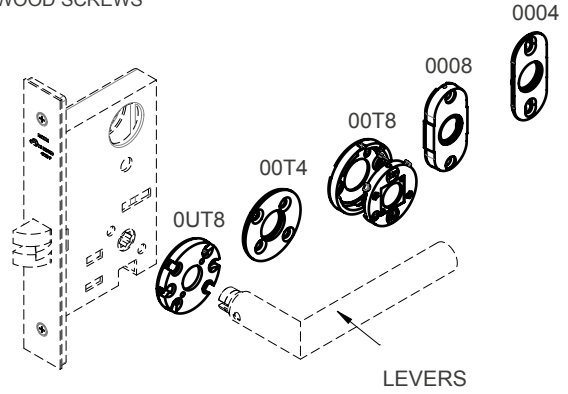

EUROPEAN MORTISE LOCK *

BTB FIXING
METRIC SCREWS + BUSHING

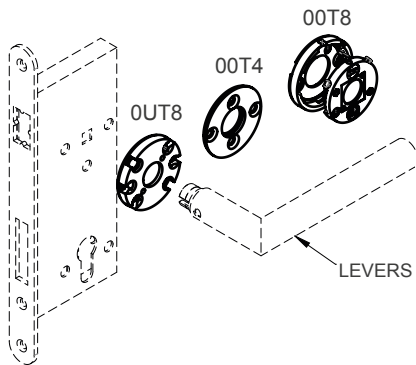

SINGLE FIXING
WOOD SCREWS

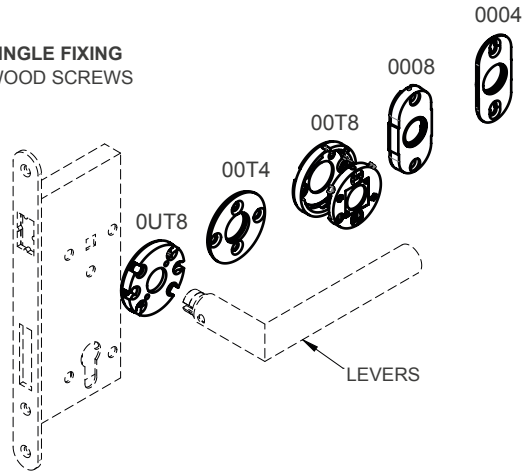

* horizontal fixing holes

BTB FIXING
METRIC SCREWS + BUSHING

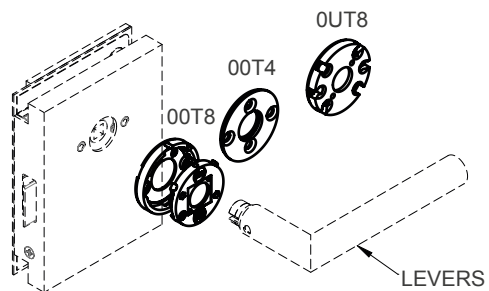
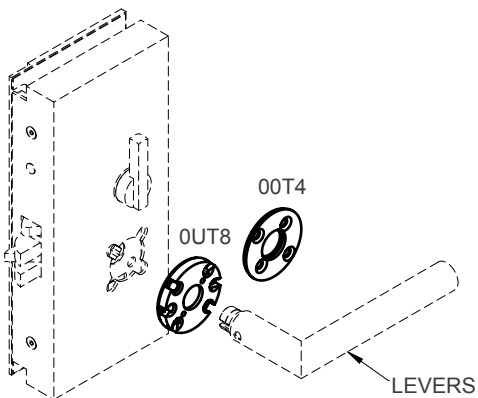

AVAILABLE TRIMS

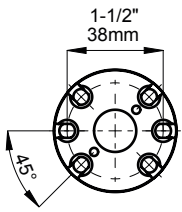

00T8 - ROUND ROSE 8 MM THICK WITH RETURN SPRING

SUITABLE FOR :
SINGLE SIDE FIXING (SELF TAPPING SCREWS FOR WOOD DOOR)
BACK TO BACK FIXING FOR LOCKSET WITH 38 mm (1-1/2")
CTC HORIZONTAL HOLES OR 45° INCLINED HOLES

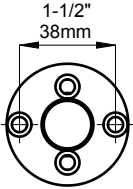
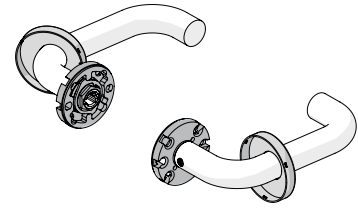

00T4 - ROUND ROSE 4 MM THICK WITHOUT RETURN SPRING (IT ROTATES FREELY)

SUITABLE FOR :
SINGLE SIDE FIXING (SELF TAPPING SCREWS FOR WOOD DOOR)
BACK TO BACK FIXING FOR LOCKSET WITH 38 mm (1-1/2")
CTC HOLES (NO MATTER IF HORIZONTAL OR INCLINED)

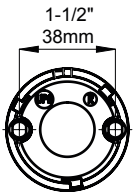
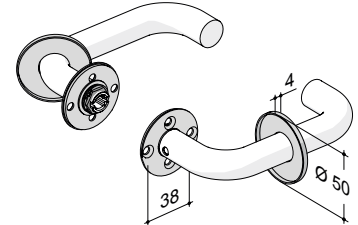

00T8 - ROUND ROSE 8 MM THICK WITH BLOK AND ROLL SYSTEM AND RETURN SPRING

SUITABLE FOR :
SINGLE SIDE FIXING (SELF TAPPING SCREWS FOR WOOD DOOR)
BACK TO BACK FIXING FOR LOCKSET WITH 38 mm (1-1/2")
CTC HORIZONTAL HOLES

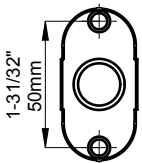
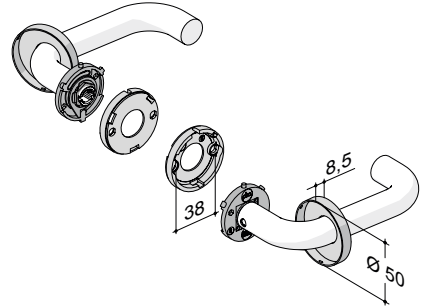

0008 - OVAL ROSE 8 MM THICK WITH RETURN SPRING

SUITABLE FOR :
SINGLE SIDE FIXING (SELF TAPPING SCREWS FOR WOOD DOOR)
BACK TO BACK FIXING FOR LOCKSET WITH 50 mm (1-31/32")
CTC VERTICAL HOLES

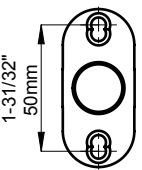
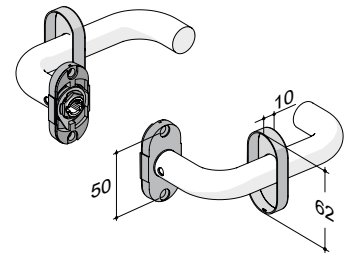

0004 - OVAL ROSE 4 MM THICK WITHOUT RETURN SPRING (IT ROTATES FREELY)

SUITABLE FOR :
SINGLE SIDE FIXING (SELF TAPPING SCREWS FOR WOOD DOOR)
BACK TO BACK FIXING FOR LOCKSET WITH 50 mm (1-31/32")
CTC VERTICAL HOLES

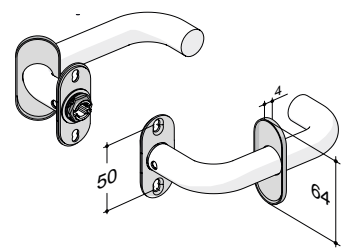

HANDLE FOR MORTISE WITH RETURN SPRING

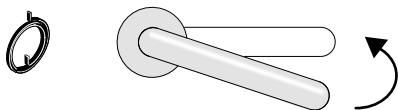

RETURN SPRING

The return spring brings back the lever handle in horizontal position after use

MOLLA DI RITORNO

La molla di ritorno riporta la leva in posizione orizzontale dopo l'utilizzo

FIXING OPTIONS

SINGLE SIDE FIXING



BACK TO BACK FIXING



SPINDLE OPTIONS

SWIVEL SPINDLE



SOLID SPINDLE



MORTISE LOCKS

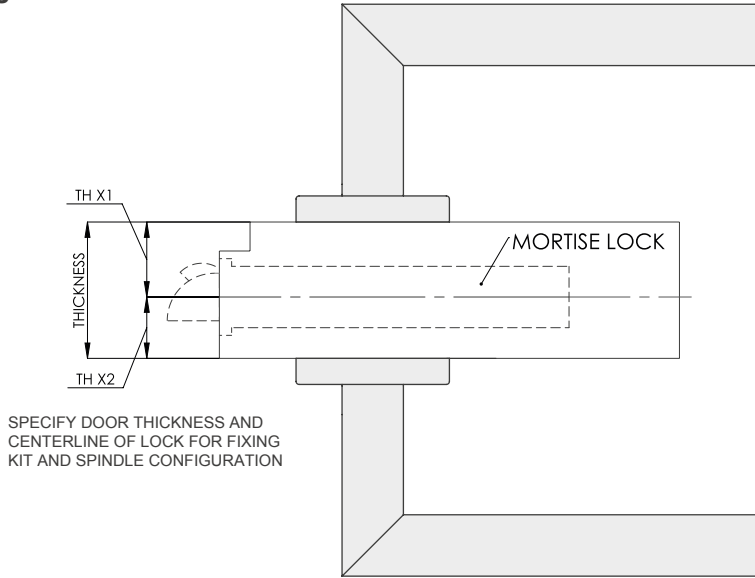

TITLE 24 COMPLIANT LEVERSET - CALIFORNIA FIRE CODE SECTION 12-10-202

Levers. The lever of lever-actuated levers or locks shall be curved with a return to within 1/2" of the face of the door to prevent catching on the clothing of persons during egress.



TITLE 24 COMPLIANCE FOR PBA PRODUCTS

SOLID DOORS (WOOD or METAL):

- 2MM.28B.00T4.xx
- 2MM.30B.00T4.xx
- 2MM.28U.0UT8.xx
- 2MM.30B.0UT8.xx

FRAMELESS GLASS DOOR WITH HGU LOCK :

- 2MM.28U.HGT4.xx
- 2MM.30B.HGT4.xx
- 2MM.28U.HGT8.xx.1(.2)
- 2MM.30U.HGT8.xx.1(.2)

FRAMELESS GLASS DOOR WITH HGL LOCK :

- 2MM.28B.HGT8.xx.1(.2)
- 2MM.30B.HGT8.xx.1(.2)

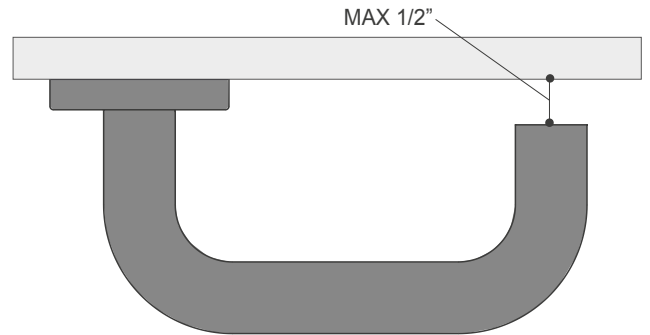

*SOLID DOOR TYPICAL INSTALLATION SHOWN

HANDLE ON PLATE WITHOUT RETURN SPRING FOR MORTISE LOCKS

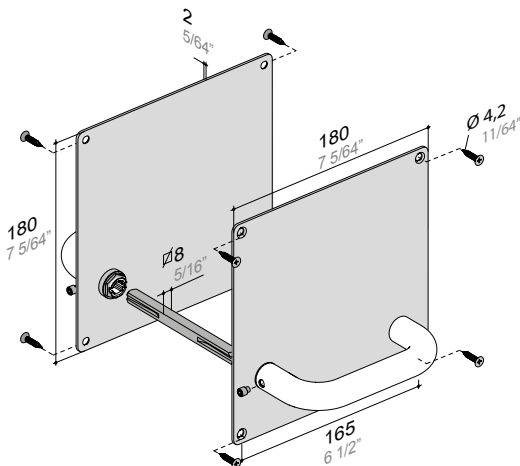

PLATES

Plates: rectangular-square with or without ball-bearings in stainless steel AISI 316L, thickness 2 mm. The ball-bearings is connected to the plate.

LATCH

ANSI CODE - FUNCTION	ILLUSTRATION INSIDE OUTSIDE	OPERATION
F75 - PASSAGE		LATCHBOLT OPERATED BY LEVER FROM EITHER SIDE AT ALL TIMES
F76A - BATHROOM		LATCHBOLT OPERATED BY LEVER FROM EITHER SIDE, EXCEPT WHEN OUTSIDE LEVER IS LOCKED BY PUSHING INSIDE BUTTON. EMERGENCY RELEASE THROUGH CLEARANCE HOLE ON THE OUTSIDE
DUMMY		BOTH LEVERS ALWAYS INOPERATIVE. NO TUBULAR LATCH INSIDE THE DOOR

SINGLE DEADBOLT LOCK

Backset 2 - 3/4" *
- key - thumbturn

ITEM
2MM.LCK.0H00. xx

* Other backset available

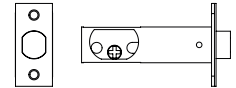

DOOR PREPARATION AND THICKNESS (ANSI/BHMA A156.115-W-2006)
DOOR THICKNESS : 35 - 45 mm (1 3/8" - 1 3/4")

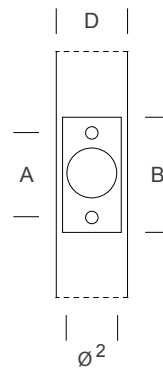
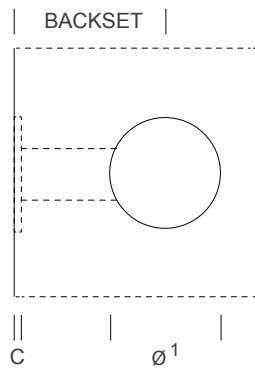

A	B	C	D	Ø¹	Ø²
41,5 mm	57,5 mm	4 mm	≥ 35 mm	54 mm	25,4 mm
1 5/8"	2 1/4"	5/32"	1 3/8"	2 1/8"	1"
			≤ 45 mm		
			1 3/4"		

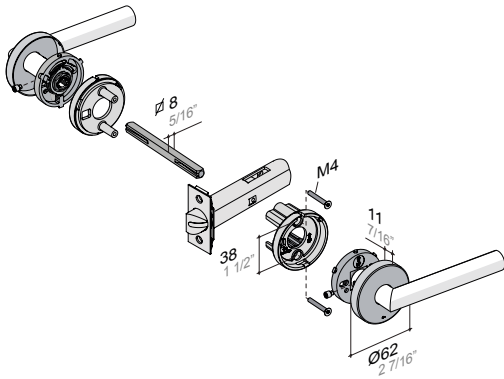

ROSES

Round roses with a return spring. Inner rose in metal alloy and rose cover in stainless steel AISI 316L. Fixing system patent Block&Roll.



Ø 62mm
2 7/16"



INSTALLATION - INSTALLAZIONE

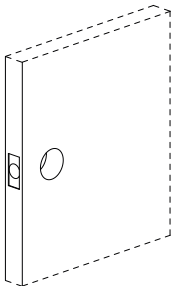
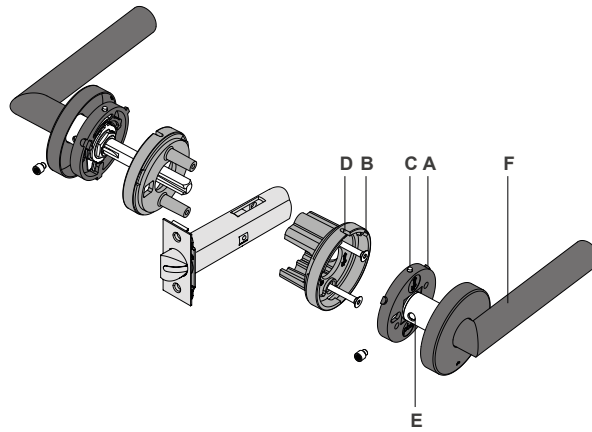

1
- Bores' preparation as per standard ANSI/BHMA A 156.115-W-2006

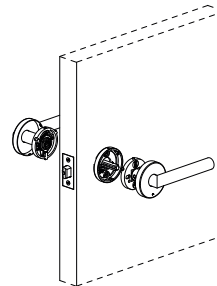

3
- Insert hold pins (A) in their seats (B), then turn until the lock pin (C) clicks in its seat (D).

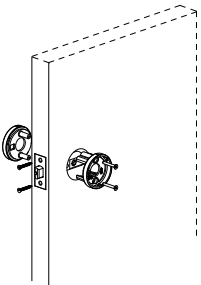

2
- Install the latch and the center supports and fix them with screws.

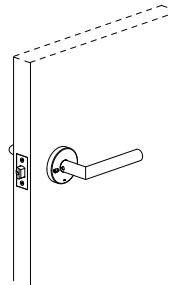

4
- Fix the levers (F) tightening the grub screws into their seats (E). Cover with

DUMMY

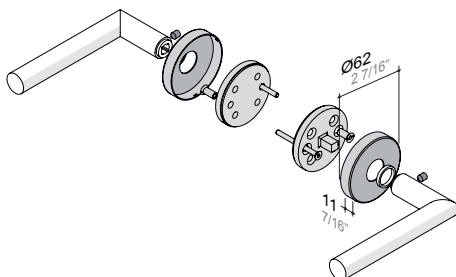

ROSES

Fixed round roses without a return spring. Inner rose in metal alloy and rose cover in stainless steel AISI 316L. Fixing system patent Block&Roll.

Ø 62mm
2 7/16"

dummy