



MADE
IN ITALY

ARCHITECTURAL
BATHWARE.
FOR ALL

IT

EN

FR

ES

FINITURA

FINISH

FINITION

ACABADO

400-NY
400-HR-NY

NYLON

.A1 = Bianco Plus .07 = Grigio
.01 = Bianco .09 = Rosso
.02 = Biscotto .10 = Nero
.03 = Giallo Pastello .17 = Antracite
.04 = Giallo
.05 = Blu Pastello

NYLON

.A1 = White Plus .07 = Grey
.01 = White .09 = Red
.02 = Biscuit .10 = Black
.03 = Light yellow .17 = Anthracite
.04 = Yellow
.05 = Light blue

NYLON

.A1 = Blanc Plus .07 = Gris
.01 = Blanc .09 = Rouge
.02 = Biscuit .10 = Noir
.03 = Jaune pastel .17 = Anthracite
.04 = Jaune
.05 = Bleu Pastel

NYLON

.A1 = Blanco Plus .07 = Gris
.01 = Blanco .09 = Rojo
.02 = Beige .10 = Negro
.03 = Amarillo Pastel .17 = Antracita
.04 = Amarillo
.05 = Azul Pastel

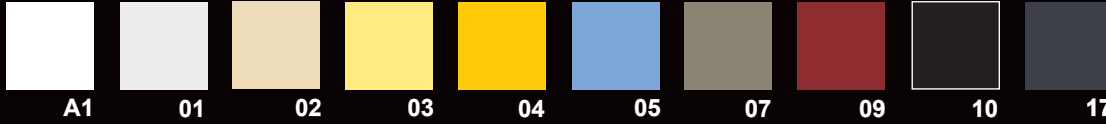

LRV

A1

01

02

03

04

05

07

09

10

17

87

76

65

27

9

5

400-ALU

.70

TUBO

Alluminio anodizzato bronzo chiaro
ACCESSORI
Nylon grigio
SUPPORTI E CURVE
Lega verniciata grigio metallizzato

.70

RAIL

Aluminium anodized light bronze
ACCESSORIES
Nylon grey
SUPPORTS AND BENDS
Powder-coated alloy metallic grey

.70

TUBE

Aluminium anodisé bronze clair
ACCESSOIRES
Nylon gris
SUPPORTS ET COUDES
Alliage laqué gris métallisé

.70

TUBO

Aluminio anodizado bronce claro
ACCESORIOS
Nylon gris
SOPORTES Y CURVAS
Lacado gris metalizado



70



71

.71

TUBO

Alluminio anodizzato argento
ACCESSORI
Nylon bianco
SUPPORTI E CURVE
Lega verniciata bianco

.71

RAIL

Aluminium anodized silver
ACCESSORIES
Nylon white
SUPPORTS AND BENDS
Powder-coated alloy white

.71

TUBE

Aluminium anodisé argent
ACCESSOIRES
Nylon blanc
SUPPORTS ET COUDES
Alliage laqué blanc

.71

TUBO

Aluminio anodizado
ACCESORIOS
Nylon blanco
SOPORTES Y CURVAS
Lacado blanco

CAP

ALLUMINIO VERNICIATO

.30 = Bianco
.24 = Grigio

Colori a richiesta:
lotti minimi da concordare



30

24

COATED ALUMINIUM

.30 = White
.24 = Grey

Colours on demand:
minimum lot to be agreed

ALUMINIUM PEINT

.30 = Blanc
.24 = Gris

Couleurs sur demande:
lots minimum à convenir

ALUMINIO PINTADO

.30 = Blanco
.24 = Gris

Colores a petición:
Lotes mínimos a convenir

ART

.75

TUBO

Alluminio anodizzato Antracite
Elevata resistenza alla corrosione
ACCESSORI
Nylon Antracite
SUPPORTI E CURVE
Lega verniciata Antracite

.75

RAIL

Aluminium anodized Anthracite
High corrosion resistance
ACCESSORIES
Nylon Anthracite
SUPPORTS AND BENDS
Powder-coated alloy Anthracite

.75

TUBE

Aluminium anodisé Anthracite
Haute résistance à la corrosion
ACCESSOIRES
Nylon Anthracite
SUPPORTS ET COUDES
Alliage laqué Anthracite

.75

TUBO

Aluminio anodizado Antracita
Alta resistencia a la corrosión
ACCESORIOS
Nylon Antracita
SOPORTES Y CURVAS
Lacado Antracita



75

17

.17

ACCESSORIES

Nylon Anthracite

.17

ACCESSOIRES

Nylon Anthracite

.17

ACCESORIOS

Nylon Antracita



ABRASION
RESISTANCE
TEST

400-SS
400-HR-SSACCIAO INOX
AISI 316L

.44 = Satinato
.43 = Lucido

STAINLESS STEEL
AISI 316L

.44 = Satined
.43 = Bright

ACIER INOXIDABLE
AISI 316L

.44 = Satiné
.43 = Poli

ACERO INOXIDABLE
AISI 316L

.44 = Mate
.43 = Brillo

IT

ART. Codice articolo
 A richiesta
 Ø Diametro
 α Angolo
 ◆ Verso: .1 Destro - .2 Sinistro



STRUTTURA CODICI ARTICOLI PBA:



- * Misura di massimo ingombro
- Peso di massimo utilizzo
- Certificato TÜV
- Conformità CE
- Non idoneo per seggiolini agganciabili
- Adipose

EN

ART. Article code
 P/s call
 Ø Diameter
 α Angle
 ◆ Side: .1 Right - .2 Left

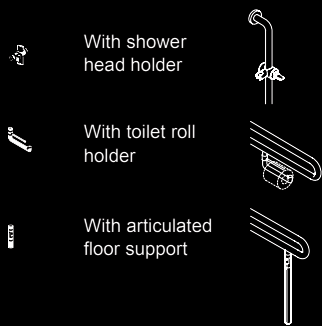

STRUCTURE OF PBA ARTICLE CODES:



- * Maximum overall dimension
- Maximum load
- TÜV Certificate
- CE Certificate
- Not suitable for suspended shower seat
- Adipose

FR

ART. Code article
 A la demande
 Ø Diamètre
 α Angle
 ◆ Sens: .1 Droite - .2 Gauche

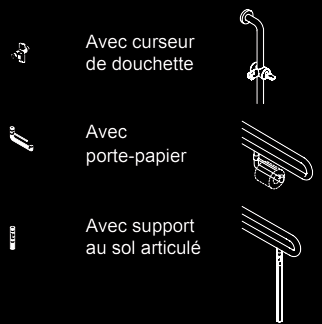

STRUCTURE CODES DES ARTICLES PBA:



- * Encombrement maximum
- Poids maximum d'utilisation
- Certificat TÜV
- Conformité CE
- Ne peut pas être utilisé avec un siège à suspendre
- Adipose

ES

ART. Código artículo
 Bajo pedido
 Ø Diámetro
 α Ángulo
 ◆ Lado: .1 Derecha - .2 Izquierda



ESTRUCTURA CÓDIGOS DE ARTICULOS PBA:



- * Tamanos máximos
- Peso máximo de utilizo
- Certificación TÜV
- Conformidad CE
- No apto para asiento para colgar
- Adipose

boob

SIAMO QUELLI CHE APRONO LE PORTE DELLE UNIVERSITÀ, DEI NEGOZI, DEGLI OSPEDALI, DEGLI EDIFICI CHE DA LUOGHI SONO DIVENTATI ICONE. SIAMO QUELLI CHE “ANCHE UNA MANIGLIA DICE CHI SIAMO QUINDI, FACCIAMOLA AL MEGLIO”, QUELLI CHE “LA SOSTENIBILITÀ È COERENZA CHE SI MOSTRA NEL LUNGO PERIODO QUINDI, PRESTIAMO ATTENZIONE ADESSO”. SIAMO QUELLI CHE FANNO SQUADRA CON I MIGLIORI E CHE HANNO LE DONNE AL COMANDO. QUELLI CHE RENDONO BELLA LA FUNZIONE DI UN PUNTO D’APPOGGIO IN UNA STANZA DA BAGNO, DI UN’IMPUGNATURA DI UN CASSETTO. FORTI COME L’ACCIAIO E SEMPRE IN CAMBIAMENTO COME IL RAME. SIAMO QUELLI CHE VI FANNO ENTRARE, USCIRE, ANDARE, RIMANERE E RITORNARE. SIAMO QUELLI DEL FARE MAI TANTO PER FARE, SEMPRE MOSSI DALL’AMBIZIONE DI CREARE OGGETTI “BUONI” PER OGNUNO E PER TUTTI. WE ARE THE ONES WHO OPEN DOORS OF UNIVERSITIES, STORES, HOSPITALS, AND BUILDINGS, THAT SHIFTED FROM PLACES TO ICONS. WE ARE THE ONES WHO “EVEN A PULL TELLS WHO WE ARE, SO LET’S DO IT EVEN BETTER”; THOSE WHO “SUSTAINABILITY IS CONSISTENCY UNVEILING IN THE LONG TERM, SO LET’S PAY ATTENTION NOW”. WE ARE THE ONES WHO TEAM UP WITH THE BEST PARTNERS, AND THOSE WHERE WOMEN ARE LEADERS. WE ARE THE ONES WHO EMBELLISH THE FUNCTION OF A GRAB BAR IN A BATHROOM, OF A DRAWER PULL. STRONG AS STEEL, CONSTANTLY-CHANGING AS COPPER. WE ARE THE ONES WHO LET YOU IN AND OUT, GO, STAY AND COME BACK. WE ARE THE ONES WHO NEVER MAKE JUST FOR THE SAKE OF MAKING, BUT ALWAYS MOVED BY THE AMBITION OF CREATING “GOOD” OBJECTS FOR ALL.



pba S.p.A.



pba Deutschland GmbH







pba USA Inc.

pba PER LA CERTIFICAZIONE LEED®

IL NOSTRO CONTRIBUTO ALL'EFFICIENZA E ALLA SOSTENIBILITÀ DEGLI EDIFICI

LEED® (LEADERSHIP IN ENERGY ENVIRONMENTAL DESIGN) È UN SISTEMA DI CERTIFICAZIONE A BASE VOLONTARIA PER LA GESTIONE, LA PROGETTAZIONE E LA COSTRUZIONE DI EDIFICI SOSTENIBILI DAL PUNTO DI VISTA SOCIALE, AMBIENTALE, ECONOMICO E DEL BENESSERE PER GLI UTILIZZATORI.

I PRODOTTI pba CONTRIBUISCONO AI PREREQUISITI E AI CREDITI LEED®.





PROCESSO INTEGRATO	IP	
MATERIALI E RISORSE	MR	
QUALITÀ DELL'AMBIENTE INTERNO	EQ	
INNOVAZIONE	IN	

pba FOR LEED® CERTIFICATION

OUR CONTRIBUTION TO THE EFFICIENCY AND SUSTAINABILITY OF BUILDINGS

LEED® (LEADERSHIP IN ENERGY ENVIRONMENTAL DESIGN) IS A VOLUNTARY CERTIFICATION SYSTEM FOR THE MANAGEMENT, DESIGN AND CONSTRUCTION OF BUILDINGS THAT ARE SUSTAINABLE FROM A SOCIAL, ENVIRONMENTAL AND ECONOMIC POINT OF VIEW AND IN TERMS OF THE WELLBEING OF THE USERS.

pba PRODUCTS CONTRIBUTE TOWARD SATISFYING PREREQUISITES AND CREDITS UNDER LEED®.





INTEGRATED PROCESS	IP	
MATERIALS AND RESOURCES	MR	
INDOOR ENVIRONMENTAL QUALITY	EQ	
INNOVATION	IN	

pba POUR LA CERTIFICATION LEED®

NOTRE CONTRIBUTION À L'EFFICACITÉ ET À LA DURABILITÉ DES BÂTIMENTS

LEED® (LEADERSHIP IN ENERGY ENVIRONMENTAL DESIGN) EST UN SYSTÈME DE CERTIFICATION À BASE VOLONTAIRE POUR LA GESTION, LA CONCEPTION ET LA CONSTRUCTION DE BÂTIMENTS DURABLES D'UN POINT DE VUE SOCIAL, ENVIRONNEMENTAL, ÉCONOMIQUE ET DU BIEN-ÊTRE POUR LES UTILISATEURS.

LES PRODUITS pba CONTRIBUENT AUX CONDITIONS PRÉALABLES REQUISES ET AUX CRÉDITS LEED®.

PROCESSUS DE CONCEPTION INTÉGRÉE	IP	
MATÉRIAUX ET RESSOURCES	MR	
QUALITÉ DES ENVIRONNEMENTS INTÉRIEURS	EQ	
INNOVATION	IN	

pba PARA LA CERTIFICACIÓN LEED®

NUESTRA CONTRIBUCIÓN EN LA EFICIENCIA Y EN LA SOSTENIBILIDAD DE LOS EDIFICIOS

LEED® (LEADERSHIP IN ENERGY ENVIRONMENTAL DESIGN) ES UN SISTEMA DE CERTIFICACIÓN DE BASE VOLUNTARIA PARA LA GESTIÓN, EL DISEÑO Y LA CONSTRUCCIÓN DE EDIFICIOS SOSTENIBLES DESDE EL PUNTO DE VISTA SOCIAL, MEDIOAMBIENTAL, ECONÓMICO Y DEL BIENESTAR PARA LOS USUARIOS.

LOS PRODUCTOS pba CONTRIBUYEN EN LOS PRE-REQUISITOS Y EN LOS CRÉDITOS LEED®.

PROCESO INTEGRADO	IP	
MATERIALES Y RECURSOS	MR	
CALIDAD DEL AMBIENTE INTERNO	EQ	
INNOVACIÓN	IN	

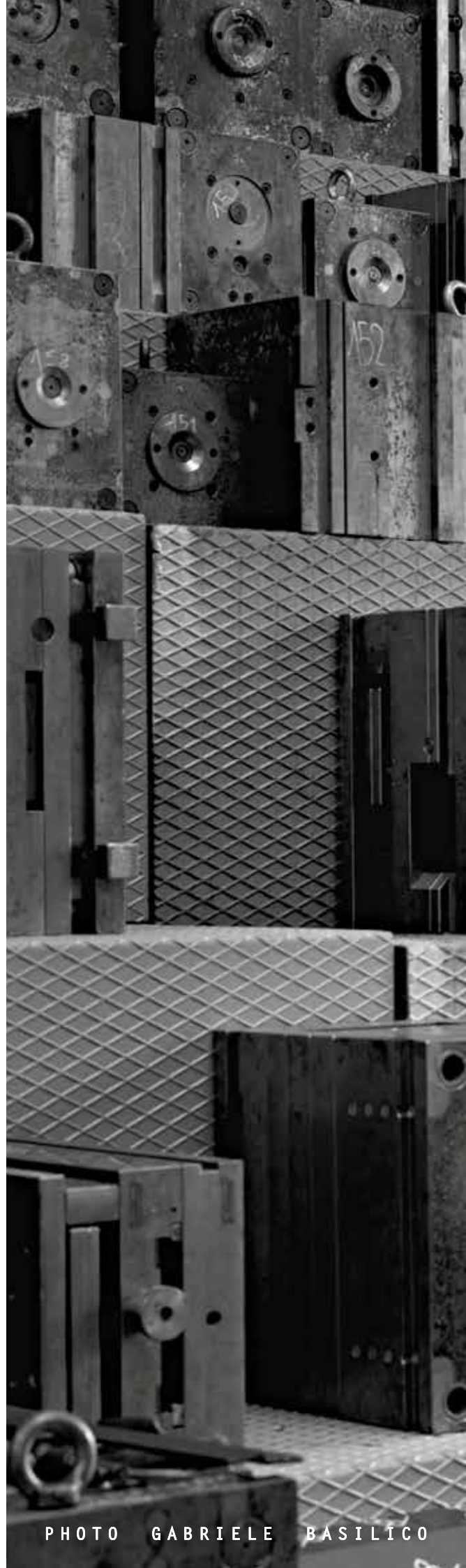

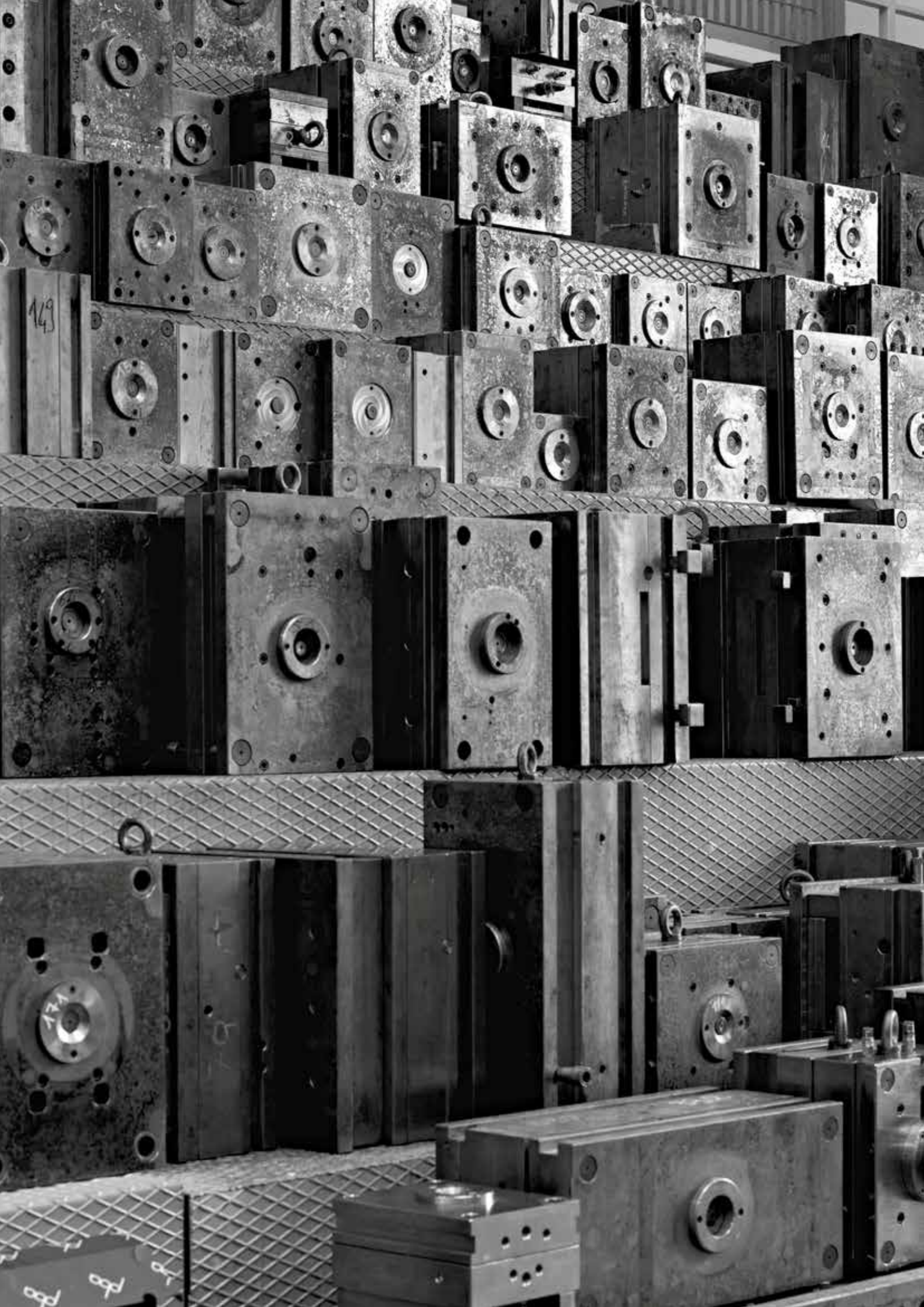

DECLARE LABEL

I NOSTRI PRODOTTI “RED LIST FREE” PER EDIFICI SOSTENIBILI

L'ETICHETTA **DECLARE** ELENCA I MATERIALI UTILIZZATI NEL PRODOTTO CON LO SCOPO DI FAR SAPERE DI COSA SONO FATTI, DOVE VENGONO PRODOTTI E COME VERRANNO SMALTITI. L'ETICHETTA **DECLARE** È UN INVITO ALLA RESPONSABILITÀ SIA PER I PRODUTTORI CHE PER GLI UTILIZZATORI.

LA **DECLARE LABEL** È UNA GUIDA PER SELEZIONARE I PRODOTTI, FORNISCE INFORMAZIONI IN MODO SEMPLICE E TRASPARENTE E METTE IN SOFFITTA IL GREENWASHING

DECLARE, PER DEFINIRE E DICHIARARE CHE I PRODOTTI SONO PRIVI DI SOSTANZE CHIMICHE DANNOSE, FA COMPLESSE ANALISI CHIMICHE E REPERISCE INFORMAZIONI A PARTIRE DALLA FONTE DELLE MATERIE PRIME. TUTTE LE **DECLARE LABEL** DEI PRODOTTI pba SONO **RED LIST FREE**.

DECLARE LABEL

OUR **DECLARE** “RED LIST FREE” PRODUCTS FOR SUSTAINABLE BUILDINGS

THE **DECLARE LABEL** LISTS THE MATERIALS IN A PRODUCT TO DISCLOSE WHAT THEY ARE MADE OF, WHERE THEY ARE PRODUCED AND HOW THEY WILL BE DISPOSED OF. THIS LABEL IS A CALL FOR RESPONSIBILITY TO PRODUCERS AND USERS ALIKE.

THE **DECLARE LABEL** IS A GUIDE TO SELECT PRODUCTS, PROVIDES INFORMATION IN A SIMPLE AND TRANSPARENT WAY AND RISES ABOVE GREENWASHING.

DECLARE TAKES COMPLEX CHEMICAL ANALYSIS AND RAW MATERIAL SOURCE LOCATION INFORMATION TO ESTABLISH THAT PRODUCTS ARE FREE FROM HAZARDOUS CHEMICALS. ALL **DECLARE LABEL** OF pba PRODUCTS ARE **RED LIST FREE**.

DECLARE LABEL

NOS PRODUITS AVEC ÉTIQUETAGE “RED LIST FREE”

L'ÉTIQUETTE **DECLARE** LISTE LES MATÉRIAUX UTILISÉS DANS LES PRODUITS AFIN DE FAIRE SAVOIR DE QUOI SONT FAITS, OÙ ILS SONT FABRIQUÉS ET COMMENT LES ÉLIMINER. L'ÉTIQUETTE **DECLARE** EST UNE INVITATION À LA RESPONSABILITÉ SOIT POUR LES PRODUCTEURS SOIT POUR LES UTILISATEURS.

LA **DECLARE LABEL** EST UNE GUIDE POUR SÉLECTIONNER LES PRODUITS, ELLE FOURNIT INFORMATIONS DE MANIÈRE SIMPLE ET TRANSPARENT ET ÉLIMINE L'ÉCOBLANCHIMENT.

DECLARE, POUR DÉFINIR ET DÉCLARER QUE LES PRODUITS NE CONTIENNENT PAS DE SUBSTANCES NUISIBLES, FAIT DES ANALYSES CHIMIQUES COMPLEXES ET RECHERCHE INFORMATIONS À PARTIR DE LA SOURCE DES MATIÈRES PREMIÈRES.

TOUTS LES ÉTIQUETTE **DECLARE** DES PRODUITS pba SONT **RED LIST FREE**, C'EST À DIRE QUI NE CONTIENNENT PAS D'INGRÉDIENTS FIGURANT DANS LA LISTE ROUGE.

DECLARE LABEL

NUESTROS PRODUCTOS CON ETIQUETA “RED LIST FREE”

LA **ETIQUETA DECLARE** HACE UNA LISTA DE LOS MATERIALES UTILIZADOS EN EL PRODUCTO CON EL OBJETIVO DE INFORMAR DE QUÉ SE COMPONEN, DÓNDE SE HACEN Y CÓMO SE ELIMINAN. LA ETIQUETA **DECLARE** ES UNA INVITACIÓN A LA RESPONSABILIDAD TANTO PARA LOS FABRICANTES COMO PARA LOS USUARIOS.

LA **DECLARE LABEL** ES UNA GUÍA PARA LA SELECCIÓN DE PRODUCTOS, DA INFORMACIONES DE MANERA SIMPLE Y TRANSPARENT Y SUPRIME EL ECOBLANQUEAMIENTO.

DECLARE, AL FIN DE DEFINIR Y DECLARAR QUE LOS PRODUCTOS NO CONTIENEN SUSTANCIAS QUÍMICAS DAÑOSAS, HACE ANÁLISIS QUÍMICAS COMPLEJAS Y OBTIENE INFORMACIONES A PARTIR DE LA ORIGEN DE LAS MATERIAS PRIMAS. TODAS LAS ETIQUETAS **DECLARE** DE LOS PRODUCTOS pba SON **RED LIST FREE**, O SEA QUE SUS COMPONENTES NO ESTÁN PRESENTE EN LA LISTA ROJA.



pba ANTI-MICROBIAL COATING AMC

RIVESTIMENTO ANTIMICROBICO

pba ANTI-MICROBIAL COATING (AMC) È UNA FINITURA INNOVATIVA CHE RIDUCE I PATOGENI MULTI-RESISTENTI DEL 99,99%. (EFFETTO DELL'ATTIVITÀ ANTIBATTERICA SU SUPERFICI IN ACCIAIO INOX E ALLUMINIO).

IL RIVESTIMENTO ANTIMICROBICO pba CONTIENE ADDITIVI SPECIALI CHE RENDONO LA SUPERFICIE PROTETTA DA BATTERI E MICROORGANISMI. I TEST DIMOSTRANO CHE SU SUPERFICI NON TRATTATE MICROBI E BATTERI POSSONO PROLIFERARE FACILMENTE MENTRE SULLE SUPERFICI TRATTATE LA PROLIFERAZIONE E' RIDOTTA A ZERO.

pba ANTI-MICROBIAL COATING AMC

ANTI-MICROBIAL COATING SURFACE FINISHING

pba ANTI-MICROBIAL COATING (AMC) IS AN INNOVATIVE FINISHING THAT REDUCES MULTI-RESISTANT PATHOGENS BY 99.99%. (EFFECT OF ANTI-BACTERIAL ACTIVITY ON STAINLESS STEEL AND ALUMINIUM SURFACES).

THE pba ANTI-MICROBIAL COATING SURFACE FINISHING CONTAINS SPECIAL ADDITIVES THAT MAKE THE SURFACE PROTECTED FROM BACTERIA AND MICROORGANISMS. THE TESTS SHOW THAT ON UNTREATED SURFACES THE MICROBES AND BACTERIA CAN EASILY PROLIFERATE WHILE ON THE TREATED SURFACES THE BACTERIAL PROLIFERATION IS ZEROED.

pba ANTI-MICROBIAL COATING AMC

REVÊTEMENT ANTI-MICROBIEN

pba ANTI-MICROBIAL COATING (AMC) EST UNE FINITION INNOVANTE QUI RÉDUIT PATHOGÈNES MULTIRÉSISTANTS DE 99,99 %. (EFFETS DE L'ACTIVITÉ ANTI-MICROBIENNE SUR LES SURFACES EN ACIER INOX ET ALUMINIUM).

LE REVÊTEMENT ANTI-MICROBIEN pba CONTIENT DES ADDITIFS SPÉCIAUX QUI PROTÈGENT LA SURFACE CONTRE LES BACTÉRIES ET LES MICRO-ORGANISMES. LES TESTS MONTRENT QUE SUR LES SURFACES TRAITÉES LA PROLIFÉRATION BACTÉRIENNE EST RÉDUITE PRATIQUEMENT À ZÉRO.

pba ANTI-MICROBIAL COATING AMC

RECUBRIMIENTO ANTI-MICROBIANO

pba ANTI-MICROBIAL COATING (AMC) ES UN ACABADO INNOVADOR QUE REDUCE LOS PATÓGENOS MULTIRRESISTENTES DEL 99,99%. (EFECTOS DE LA ACTIVIDAD ANTI-MICROBIANA SOBRE LAS SUPERFICIES DE ACERO INOX Y ALUMINIO).

EL RECUBRIMIENTO ANTI-MICROBIANO pba CONTIENE ADITIVOS ESPECIALES QUE HACEN PROTEGER LA SUPERFICIE CONTRA LAS BACTERIAS Y LOS MICROORGANISMOS. LAS PRUEBAS HAN DEMOSTRADO QUE LA PROLIFERACIÓN DE BACTERIAS SOBRE LAS SUPERFICIES TRATADAS ES REDUCIDA A CERO.

AMC FINISH

STAINLESS STEEL POWDER COATED

AMC

 TRANSPARENT SATIN

 TRANSPARENT BRIGHT

 BLACK RAL 9005

 WHITE RAL 9010

ANODIZED ALUMINUM POWDER COATED

AMC

 TRANSPARENT SILVER

 TRANSPARENT LIGHT BRONZE

 TRANSPARENT DARK BRONZE

 TRANSPARENT BLACK

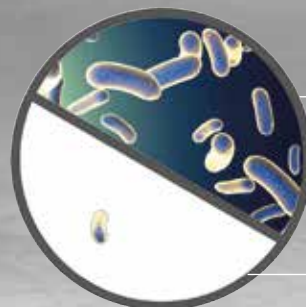

MULTI-RESISTANT PATHOGENS DEVELOP WITHOUT pba AMC

pba AMC REDUCES PATHOGENS BY ABOUT 99.99%



7 PRINCIPLES OF UNIVERSAL DESIGN



01
EQUITABLE
USE

THE DESIGN IS USEFUL AND MARKETABLE TO PEOPLE WITH DIVERSE ABILITIES.



02
FLEXIBILITY
IN USE

THE DESIGN ACCOMMODATES A WIDE RANGE OF INDIVIDUAL PREFERENCES AND ABILITIES.



03
SIMPLE AND
INTUITIVE USE

USE OF THE DESIGN IS EASY TO UNDERSTAND, REGARDLESS OF THE USER'S EXPERIENCE, KNOWLEDGE, LANGUAGE SKILLS, OR CURRENT CONCENTRATION LEVEL.



04
PERCEPTIBLE
INFORMATION

THE DESIGN COMMUNICATES NECESSARY INFORMATION EFFECTIVELY TO THE USER, REGARDLESS OF AMBIENT CONDITIONS OR THE USER'S SENSORY ABILITIES.



05
TOLERANCE
FOR ERROR

THE DESIGN MINIMIZES HAZARDS AND THE ADVERSE CONSEQUENCES OF ACCIDENTAL OR UNINTENDED ACTIONS.



06
LOW PHYSICAL
EFFORT

THE DESIGN CAN BE USED EFFICIENTLY AND COMFORTABLY AND WITH A MINIMUM OF FATIGUE. LESS THAN 5 POUNDS.



07
SIZE AND SPACE FOR
APPROACH AND USE

APPROPRIATE SIZE AND SPACE IS PROVIDED FOR APPROACH, REACH, MANIPULATION, AND USE, REGARDLESS OF USER'S BODY SIZE, POSTURE, OR MOBILITY.

UNIVERSAL DESIGN



MAKING DESIGN ACCESSIBLE TO EVERYONE

BEST OF NEOCON
INNOVATION

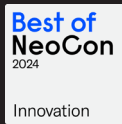

#METROPOLISLIKES NYCXDESIGN
WINNER



BEST OF NEOCON
GOLD

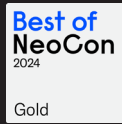

GLOBAL FUTURE DESIGN AWARDS
THIRD AWARD



NYCXDESIGN AWARDS
HONOREE



IDEA INTERNATIONAL DESIGN
EXCELLENCE AWARDS
FINALIST



NYCXDESIGN AWARDS
FINALIST



V ADI CERAMICS & BATHROOM
DESIGN AWARD
SPECIAL MENTION



EUROPEAN PRODUCT DESIGN AWARD
WINNER



XXIII COMPASSO D'ORO AWARD
NOMINATION



EUROPEAN PRODUCT DESIGN AWARD
HONORABLE MENTION



REDDOT DESIGN AWARD
WINNER



reddot design award

GLOBAL FUTURE DESIGN AWARDS
WINNER



REDDOT DESIGN AWARD
NOMINATION



reddot design award

NYCXDESIGN AWARDS
FINALIST



XXI COMPASSO D'ORO AWARD
NOMINATION



YOUR ARCHITECTURAL DESIGN FOR ALL



PROGRAMMA 400-NY

Poliamide 6
Polyamide 6
Polyamide 6
Poliamida 6

Page 18



PROGRAMMA 400-ALU

Alluminio
Aluminum alloy
Aluminium
Aluminio

Page 106



PROGRAMMA CAP

Alluminio verniciato
Coated aluminum
Aluminium peint
Aluminio pintado

Page 148



PROGRAMMA ART

Alluminio anodizzato antigraffio
Scratch-resistant anodized aluminum
Aluminium anodizé anti-rayure
Aluminio anodizado anti-arañazos

Page 186





PROGRAMMA 400-SS

Acciaio inox aisi 316l
Stainless steel aisi 316l
Acier inoxydable aisi 316l
Acero inoxidable aisi 316l

Page 218



PROGRAMMA HAND SANITIZER COVER

Acciaio inox aisi 316l Verniciato
Stainless steel aisi 316l Powder-coated
Acier inoxydable aisi 316l Laque
Acero inoxidable aisi 316l Pintado

Page 276



PROGRAMMA 400-HR

Poliammide 6 Acciaio inox aisi 316l Legno
Polyamide 6 Stainless steel aisi 316l Wood
Polyamide 6 Acier inoxydable aisi 316l Bois
Poliamida 6 Acero inoxidable aisi 316l Madera

Page 286



INFORMAZIONI TECNICHE
TECHNICAL INFORMATION
INFORMATIONS TECHNIQUES
TECHNISCHE INFORMATIE

Page 295





POLIAMMIDE 6 - POLYAMIDE 6 - POLYAMIDE 6 - POLIAMIDA 6

IL POLIAMMIDE 6 È UNA RESINA TERMOPLASTICA AD ALTA RESISTENZA MECCANICA, CON OTTIMA TENACITÀ AGLI URTI ED ALTA RESISTENZA AD USURA E ABRASIONE. CLASSIFICATA COME AUTOESTINGUENTE DI CATEGORIA UL 94V-2, NON EMANA GAS TOSSICI, È UN MATERIALE SICURO, PRATICAMENTE INDEFORMABILE E MOLTO DUREVOLE.

POLYAMIDE 6 IS A THERMOPLASTIC RESIN WITH HIGH MECHANICAL RESISTANCE, EXCELLENT TOUGHNESS TO IMPACTS AND HIGH RESISTANCE TO WEAR AND ABRASION. CLASSIFIED AS A SELF-EXTINGUISHING UL 94V-2 CATEGORY, POLYAMIDE 6 DOES NOT GENERATE TOXIC GASES, IT IS A SAFE MATERIAL, HARDLY DEFORMABLE AND VERY DURABLE.

LE POLYAMIDE 6 EST UNE RÉSINE THERMOPLASTIQUE AVEC UNE RÉSISTANCE MÉCANIQUE ÉLEVÉE, UNE TRÈS BONNE DURETÉ AUX IMPACTS ET UNE HAUTE RÉSISTANCE À L'USURE ET À L'ABRASION. CLASSIFIÉ COMME AUTO-EXTINGUIBLE DE TYPE UL 94V-2, NE LIBÈRE PAS DE GAZ TOXIQUES, IL S'AGIT D'UN MATÉRIEL SÛR PRESQUE INDÉFORMABLE ET TRÈS DURABLE.

LA POLIAMIDA 6 ES UNA RESINA TERMOPLÁSTICA DE ALTA RESISTENCIA MECÁNICA, CON EXCELENTE TENACIDAD AL IMPACTO Y ALTA RESISTENCIA AL DESGASTE Y LA ABRASIÓN. CLASIFICADA COMO AUTOEXTINGUIBLE DE CLASE UL 94V-2, NO EMANA GASES TÓXICOS, ES UN MATERIAL SEGURO, PRÁCTICAMENTE INDEFORMABLE Y MUY DURADERO.

COLORI - COLOURS - COULEURS - COLORES

NON ESISTE ALCUNA CORRISPONDENZA TRA I COLORI DEI NOSTRI PEZZI STAMPATI / ESTRUSI IN POLIAMMIDE 6 CON I COLORI RAL. I COLORI RAL INDICATI NELLA TABELLA QUI RIPORTATA RAPPRESENTANO SOLO I COLORI CHE IN QUALCHE MODO SI AVVICINANO ALLE NOSTRE COLORAZIONI TENENDO IN CONSIDERAZIONE CHE IN ALCUNI CASI LE DIFFERENZE SONO PIUTTOSTO MARCATE E CHE TALE CORRISPONDENZA NASCE DA CONSIDERAZIONI SPESSO SOGGETTIVE. IN MOLTI CASI INFATTI I COMPONENTI IN PLASTICA pba PRESENTANO COLORAZIONI CHE SI PONGONO IN POSIZIONE INTERMEDIA RISPETTO A DUE DIFFERENTI RAL. PER UN'OPPORTUNA VALUTAZIONE DEL COLORE È NECESSARIO PRENDERE VISIONE DI UN CAMPIONE.

THERE IS NO CORRESPONDENCE BETWEEN THE COLOURS OF pba 6 POLYAMIDE EXTRUDED/STAMPED PRODUCTS AND THE RAL CHART. THE RAL STANDARDS INDICATED ONLY REPRESENT AN INDICATION OF pba'S COLOURS, TAKING INTO ACCOUNT THAT THEY COULD BE CONSIDERELY DIFFERENT FROM EACH OTHER, MOSTLY DEPENDING ON PERSONAL PERCEPTION AS WELL AS MONITOR AND PRINTER SETTINGS. SOMETIMES pba PLASTIC PRODUCTS COULD STAND BETWEEN TWO COLOURS OR THERE COULD BE NO MATCH AT ALL. pba ADVICES TO REQUEST A SAMPLE FOR AN ACCURATE CHOICE.

IL N'Y A AUCUNE CORRESPONDANCE ENTRE LES COULEURS DE NOS PIÈCES IMPRIMÉES / EXTRUDÉES EN POLYAMMIDE 6 AVEC LES COULEURS RAL. LES COULEURS RAL INDIQUÉS DANS LE TABLEAU REPRÉSENTENT SEULEMENT LES COULEURS QUE DE QUELQUE FAÇON SE RAPPROCHENT À NOS COLORATIONS, TOUTEFOIS, IL FAUT BIEN CONSIDÉRER QUE DANS CERTAINS CAS LES DIFFÉRENCES SONT ASSEZ ÉVIDENTES ET QUE CETTE CORRESPONDANCE VIENT DE CONSIDÉRATIONS SOUVENT SUBJECTIVES. EN EFFET BIEN SOUVENT LES COMPOSANTS EN PLASTIQUE pba ONT DES COLORATIONS QUI SE POSENT DANS UNE ÉTAPE INTERMÉDIAIRE PAR RAPPORT À DEUX RAL DIFFÉRENTS.

AFIN D'AIDER DANS LE CHOIX DE LA COULEUR, pba CONSEILLE D'EXAMINER UN ÉCHANTILLON

LOS COLORES RAL INDICADOS EN LA TABLA REPRESENTAN LOS COLORES QUE MÁS SE ACERCAN A LOS DEL PROGRAMA 400-NY. NO EXISTE UNA EQUIVALENCIA CERTIFICADA ENTRE LOS COLORES DE NUESTROS PRODUCTOS MOLDEADOS O EXTRUSIONADOS DE POLIAMIDA 6 Y LOS COLORES RAL INDICADOS. EN ALGUNOS CASOS LAS DIFERENCIAS PUEDEN RESULTAR MÁS MARCADAS, PORQUE ESTÁN POR CONSIDERACIONES SUBJETIVAS. EN OTROS CASOS, LOS COMPONENTES DE PLÁSTICO pba PUEDEN PRESENTAR COLORES SITUADOS EN UNA POSICIÓN INTERMEDIA ENTRE DOS COLORES RAL DIFERENTES, MIENTRAS QUE PARA ALGUNOS COLORES SIMPLEMENTE NO ES POSIBLE UNA EQUIVALENCIA CON LAS REFERENCIAS RAL. pba ACONSEJA EXAMINAR UNA MUESTRA PARA AYUDAR LA ELECCIÓN DEL COLOR.

LRV - LIGHT REFLECTION VALUE

L'LRV (LIGHT REFLECTANCE VALUE – INDICE DI RIFLETTENZA DELLA LUCE) SI BASA SU UNA SCALA DA 0 A 100: LO 0, RAPPRESENTA UNA SUPERFICIE PERFETTAMENTE ASSORBENTE CHE POTREBBE ESSERE CONSIDERATA COME TOTALMENTE NERA, MENTRE IL 100, RAPPRESENTA UNA SUPERFICIE PERFETTAMENTE RIFLETTENTE CHE POTREBBE ESSERE CONSIDERATA COME PERFETTAMENTE BIANCA. IL CONTRASTO VISIVO È DATO COME DIFFERENZA DI LRV TRA DUE SUPERFICI. I PRINCIPI LEGATI ALLA PERCEZIONE DELL'INFORMAZIONE DELL'UNIVERSAL DESIGN STABILISCONO CHE IL PROGETTO ARCHITETTONICO DEVE COMUNICARE LE INFORMAZIONI IN MODO EFFICACE INDIPENDENTEMENTE DALLE CONDIZIONI AMBIENTALI.

THE LRV (LIGHT REFLECTANCE VALUE) IS BASED ON A SCALE OF 0:100: THE 0, WHICH IS A PERFECTLY ABSORBING SURFACE THAT COULD BE ASSUMED TO BE TOTALLY BLACK, AND THE 100, WHICH IS A PERFECTLY REFLECTIVE SURFACE THAT COULD BE CONSIDERED TO BE THE PERFECT WHITE. THE VISUAL CONTRAST IS GIVEN AS A DIFFERENCE IN LRV BETWEEN TWO SURFACES. THE PERCEPTIBLE INFORMATION PRINCIPLES OF THE UNIVERSAL DESIGN STATES THAT THE DESIGN HAS TO COMMUNICATE INFORMATION EFFECTIVELY REGARDLESS OF AMBIENT CONDITIONS.











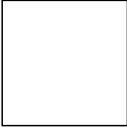
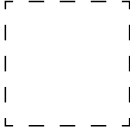

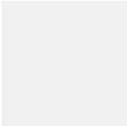
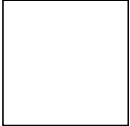

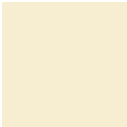



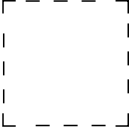









LE COEFFICIENT DE RÉFLEXION LUMINEUSE (LRV) SE BASE SUR UNE ÉCHELLE DE 0:100 : LE 0, QUI EST UNE SURFACE PARFAITEMENT ABSORBANTE QUI PEUT ÊTRE CONSIDÉRÉE TOTALEMENT NOIR ET LE 100, QUI EST UNE SURFACE PARFAITEMENT RÉFLÉCHISSANTE QUI PEUT ÊTRE CONSIDÉRÉE COMME LE BLANC PUR. LE CONTRASTE VISUEL EST LE RÉSULTAT DE LA DIFFÉRENCE DU COEFFICIENT DE RÉFLEXION LUMINEUSE (LRV) ENTRE DEUX SURFACES. LES PRINCIPES DU DESIGN UNIVERSEL AFFIRMENT QUE LE DESIGN DOIT COMMUNIQUER EFFICACEMENT LES INFORMATIONS QUELLES QUE SOIENT LES CONDITIONS DE L'ENVIRONNEMENT.

EL LRV (LIGHT REFLECTANCE VALUE - VALOR DE REFLECTANCIA DE LA LUZ) SE BASA EN UNA ESCALA QUE VA DESDE 0 HASTA 100: EL 0 REPRESENTA UNA SUPERFICIE PERFECTAMENTE ABSORBENTE QUE PODRÍA SER ASUMIDA A SER TOTALMENTE NEGRO, Y EL 100, QUE REPRESENTA UNA SUPERFICIE PERFECTAMENTE REFLECTANTE QUE PODRÍA SER CONSIDERADO A SER EL BLANCO PERFECTO. EL CONTRASTE VISUAL SE ALCANZA COMO DIFERENCIA DE LRV ENTRE DOS SUPERFICIES. LOS PRINCIPIOS DE INFORMACIÓN PERCEPTIBLE DEL DISEÑO UNIVERSAL DECLARAN QUE EL PROYECTO ARQUITECTURAL DEBE TRANSMITIR LAS INFORMACIONES DE MANERA EFECTIVA SIN IMPORTAR LAS CONDICIONES DEL AMBIENTE.

pba

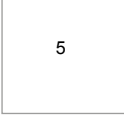
RAL

LRV *

	.A1 BIANCO PLUS WHITE PLUS BLANC PLUS BLANCO PLUS		NESSUNA CORRISPONDENZA NO CORRESPONDANCE SANS CORRESPONDANCE NINGUNA CORRESPONDENCIA	
	.01 BIANCO WHITE BLANC BLANCO		RAL 9016	
	.02 BISCOTTO BISCUIT BISCUIT BEIGE		RAL 1013	
	.03 GIALLO PASTELLO LIGHT YELLOW JAUNE PASTEL AMARILLO PASTEL		NESSUNA CORRISPONDENZA NO CORRESPONDANCE SANS CORRESPONDANCE NINGUNA CORRESPONDENCIA	
	.04 GIALLO YELLOW JAUNE AMARILLO		RAL 1023 - RAL 1021	
	.05 BLU PASTELLO LIGHT BLUE BLEU PASTEL AZUL PASTEL		NESSUNA CORRISPONDENZA NO CORRESPONDANCE SANS CORRESPONDANCE NINGUNA CORRESPONDENCIA	
	.07 .GRIGIO GREY GRIS GRIS		RAL 7038 - RAL 7030	
	.09 ROSSO RED ROUGE ROJO		RAL 3003 - RAL 3002	
	.10 NERO BLACK NOIR NEGRO		RAL 9005	
	.17 ANTRACITE ANTHRACITE ANTHRACITE ANTRACITA		RAL 7021	

pba PER LA CERTIFICAZIONE LEED®

LEED® (LEADERSHIP IN ENERGY ENVIRONMENTAL DESIGN) È UN SISTEMA DI CERTIFICAZIONE A BASE VOLONTARIA PER LA GESTIONE, LA PROGETTAZIONE E LA COSTRUZIONE DI EDIFICI SOSTENIBILI DAL PUNTO DI VISTA SOCIALE, AMBIENTALE, ECONOMICO E DEL BENESSERE PER GLI UTILIZZATORI.





I PRODOTTI pba CONTRIBUISCONO AI PREREQUISITI E AI CREDITI LEED®.

PROCESSO INTEGRATO	IP	
MATERIALI E RISORSE	MR	
QUALITÀ DELL'AMBIENTE INTERNO	EQ	
INNOVAZIONE	I	

pba FOR LEED® CERTIFICATION

LEED® (LEADERSHIP IN ENERGY ENVIRONMENTAL DESIGN) IS A VOLUNTARY CERTIFICATION SYSTEM FOR THE MANAGEMENT, DESIGN AND CONSTRUCTION OF BUILDINGS THAT ARE SUSTAINABLE FROM A SOCIAL, ENVIRONMENTAL AND ECONOMIC POINT OF VIEW AND IN TERMS OF THE WELLBEING OF THE USERS.





pba PRODUCTS CONTRIBUTE TOWARD SATISFYING PREREQUISITES AND CREDITS UNDER LEED®.

INTEGRATED PROCESS	IP	
MATERIALS AND RESOURCES	MR	
INDOOR ENVIRONMENTAL QUALITY	EQ	
INNOVATION	I	

pba POUR LA CERTIFICATION LEED®

LEED® (LEADERSHIP IN ENERGY ENVIRONMENTAL DESIGN) EST UN SYSTÈME DE CERTIFICATION À BASE VOLONTAIRE POUR LA GESTION, LA CONCEPTION ET LA CONSTRUCTION DE BÂTIMENTS DURABLES D'UN POINT DE VUE SOCIAL, ENVIRONNEMENTAL, ÉCONOMIQUE ET DU BIEN-ÊTRE POUR LES UTILISATEURS.

LES PRODUITS pba CONTRIBUENT AUX CONDITIONS PRÉALABLES REQUISES ET AUX CRÉDITS LEED®.

PROCESSUS DE CONCEPTION INTÉGRÉE	IP	
MATÉRIAUX ET RESSOURCES	MR	
QUALITÉ DES ENVIRONNEMENTS INTÉRIEURS	EQ	
INNOVATION	I	

pba PARA LA CERTIFICACIÓN LEED®

LEED® (LEADERSHIP IN ENERGY ENVIRONMENTAL DESIGN) ES UN SISTEMA DE CERTIFICACIÓN DE BASE VOLUNTARIA PARA LA GESTIÓN, EL DISEÑO Y LA CONSTRUCCIÓN DE EDIFICIOS SOSTENIBLES DESDE EL PUNTO DE VISTA SOCIAL, MEDIOAMBIENTAL, ECONÓMICO Y DEL BIENESTAR PARA LOS USUARIOS.

LOS PRODUCTOS pba CONTRIBUYEN EN LOS PRE-REQUISITOS Y EN LOS CRÉDITOS LEED®.

PROCESO INTEGRADO	IP	
MATERIALES Y RECURSOS	MR	
CALIDAD DEL AMBIENTE INTERNO	EQ	
INNOVACIÓN	I	

CHART OF PBA PRODUCTS CONTRIBUTION TO LEED V4

INTEGRATIVE PROCESS

IP PREREQUISITE INTEGRATIVE PROCESS PLANNING AND DESIGN

MATERIALS AND RESOURCES

MR PREREQUISITE CONSTRUCTION AND DEMOLITION WASTE MANAGEMENT PLANNING

MR CREDIT CONSTRUCTION AND DEMOLITION WASTE MANAGEMENT

MR CREDIT BUILDING PRODUCT DISCLOSURE AND OPTIMIZATION - SOURCING OF RAW MATERIALS
➔ OPTION 2 LEADERSHIP EXTRACTION PRACTICES

MR CREDIT BUILDING PRODUCT DISCLOSURE AND OPTIMIZATION - MATERIAL INGREDIENTS
➔ OPTION 2 MATERIAL INGREDIENT OPTIMIZATION

INDOOR ENVIRONMENTAL QUALITY

EQ CREDIT LOW EMITTING MATERIALS

EQ CREDIT CONSTRUCTION AIR QUALITY MANAGEMENT PLAN

INNOVATION

IN PILOT CREDIT  DESIGN FOR FLEXIBILITY

IN PILOT CREDIT  SOCIAL EQUITY

IN PILOT CREDIT  INCLUSIVE DESIGN

IN CREDIT  DESIGN FOR DECONSTRUCTION

DECLARE LABEL

L'**ETICHETTA DECLARE** ELENCA I MATERIALI UTILIZZATI NEL PRODOTTO CON LO SCOPO DI FAR SAPERE DI COSA SONO FATTI, DOVE VENGONO PRODOTTI E COME VERRANNO SMALTITI. L'ETICHETTA DECLARE È UN INVITO ALLA RESPONSABILITÀ SIA PER I PRODUTTORI CHE PER GLI UTILIZZATORI.

LA **DECLARE LABEL** È UNA GUIDA PER SELEZIONARE I PRODOTTI, FORNISCE INFORMAZIONI IN MODO SEMPLICE E TRASPARENTE E METTE IN SOFFITTA IL GREENWASHING DECLARE, PER DEFINIRE E DICHIARARE CHE I PRODOTTI SONO PRIVI DI SOSTANZE CHIMICHE DANNOSE, FA COMPLESSE ANALISI CHIMICHE E REPERISCE INFORMAZIONI A PARTIRE DALLA FONTE DELLE MATERIE PRIME. TUTTE LE DECLARE LABEL DEI PRODOTTI pba SONO **RED LIST FREE**.

DECLARE LABEL

THE **DECLARE LABEL** LISTS THE MATERIALS IN A PRODUCT TO DISCLOSE WHAT THEY ARE MADE OF, WHERE THEY ARE PRODUCED AND HOW THEY WILL BE DISPOSED OF. THIS LABEL IS A CALL FOR RESPONSIBILITY TO PRODUCERS AND USERS ALIKE.

THE **DECLARE LABEL** IS A GUIDE TO SELECT PRODUCTS, PROVIDES INFORMATION IN A SIMPLE AND TRANSPARENT WAY AND RISES ABOVE GREENWASHING.

DECLARE TAKES COMPLEX CHEMICAL ANALYSIS AND RAW MATERIAL SOURCE LOCATION INFORMATION TO ESTABLISH THAT PRODUCTS ARE FREE FROM HAZARDOUS CHEMICALS. ALL DECLARE LABEL OF pba PRODUCTS ARE **RED LIST FREE**.

DECLARE LABEL

L'**ÉTIQUETTE DECLARE** LISTE LES MATÉRIAUX UTILISÉS DANS LES PRODUITS AFIN DE FAIRE SAVOIR DE QUOI SONT FAITS, OÙ ILS SONT FABRIQUÉS ET COMMENT LES ÉLIMINER. L'ÉTIQUETTE DECLARE EST UNE INVITATION À LA RESPONSABILITÉ SOIT POUR LES PRODUCTEURS SOIT POUR LES UTILISATEURS.

LA **DECLARE LABEL** EST UNE GUIDE POUR SÉLECTIONNER LES PRODUITS, ELLE FOURNIT INFORMATIONS DE MANIÈRE SIMPLE ET TRASPARENTE ET ÉLIMINE L'ÉCOBLANCHIMENT.

DECLARE, POUR DÉFINIR ET DÉCLARER QUE LES PRODUITS NE CONTIENNENT PAS DE SUBSTANCES NUISIBLES, FAIT DES ANALYSES CHIMIQUES COMPLEXES ET RECHERCHE INFORMATIONS À PARTIR DE LA SOURCE DES MATIÈRES PREMIÈRES.

TOUS LES ÉTIQUETTE DECLARE DES PRODUITS pba SONT **RED LIST FREE**, C'EST À DIRE QUI NE CONTIENNENT PAS D'INGRÉDIENTS FIGURANT DANS LA LISTE ROUGE.

DECLARE LABEL

LA **ETIQUETA DECLARE** HACE UNA LISTA DE LOS MATERIALES UTILIZADOS EN EL PRODUCTO CON EL OBJETIVO DE INFORMAR DE QUÉ SE COMPONEN, DÓNDE SE HACEN Y CÓMO SE ELIMINAN. LA ETIQUETA DECLARE ES UNA INVITACIÓN A LA RESPONSABILIDAD TANTO PARA LOS FABRICANTES COMO PARA LOS USUARIOS.

LA **DECLARE LABEL** ES UNA GUÍA PARA LA SELECCIÓN DE PRODUCTOS, DA INFORMACIONES DE MANERA SIMPLE Y TRASPARENTE Y SUPRIME EL ECOBLANQUEAMIENTO.

DECLARE, AL FIN DE DEFINIR Y DECLARAR QUE LOS PRODUCTOS NO CONTIENEN SUSTANCIAS QUÍMICAS DAÑOSAS, HACE ANÁLISIS QUÍMICAS COMPLEJAS Y OBTIENE INFORMACIONES A PARTIR DE LA ORIGEN DE LAS MATERIAS PRIMAS. TODAS LAS ETIQUETAS DECLARE DE LOS PRODUCTOS pba SON **RED LIST FREE**, O SEA QUE SUS COMPONENTES NO ESTÁN PRESENTE EN LA LISTA ROJA.



Declare.

POLYAMIDE-6 BATHROOM ACCESSORIES

pba

Final Assembly: Tezze sul Brenta, Vicenza, Italy

Life Expectancy: 20 Year(s)

End of Life Options: Recyclable (100%)

Ingredients:

Polyamide 6: Nylon 6; **Aluminium 46100:** Aluminum; **Alluminio LEGA EN AW-6060:** Aluminum; **Stainless Steel AISI 316L:** Stainless Steel AISI 316; **Stainless Steel AISI 304:** Stainless Steel AISI 316; **Zinc Casting Alloys:** Zinc; Aluminum; Copper; **Brass:** Brass

Living Building Challenge Criteria: Compliant

I-13 Red List:

- LBC Red List Free % Disclosed: 100% at 100ppm
- LBC Red List Approved VOC Content: Not Applicable
- Declared

I-10 Interior Performance: AgBB Scheme French A+ 2011

I-14 Responsible Sourcing: Not Applicable

PBA-0006

Original Issue Date: 2021

SOSTEGNI DI SICUREZZA
SAFETY SUPPORTS
BARRES D'APPUI
ASIDEROS

Page 28



AUSILI DI SICUREZZA RIBALTABILI
LIFT-UP SAFETY SUPPORTS
BARRES D'APPUI RELEVABLES
ASIDEROS ABATIBLES

Page 40

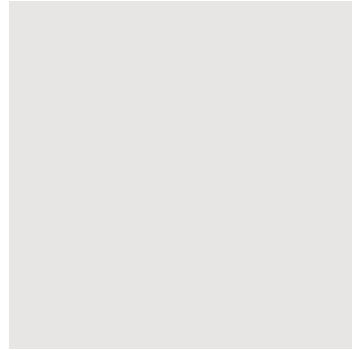

SEGGIOLINI
SEATS
SIÈGES
ASIENTOS

Page 54



ACCESSORI BAGNO
BATHROOM ACCESSORIES
ACCESSOIRES DE BAIN
ACCESORIOS DE BAÑO

Page 64



SERIE ADIPOSE
ADIPOSE SERIE
SÉRIE ADIPOSE
SERIE ADIPOSE



Page 96

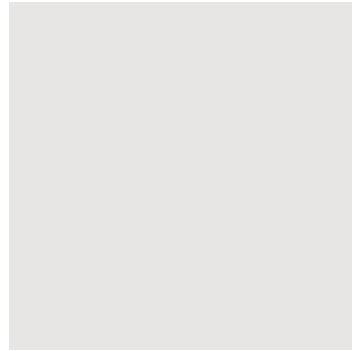

SERIE ANTISUICIDE
ANTISUICIDE SERIE
SÉRIE ANTISUICIDE
SERIE ANTISUICIDE

Page 102

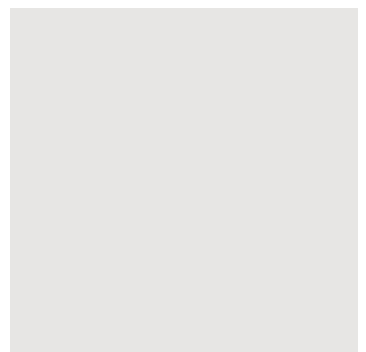
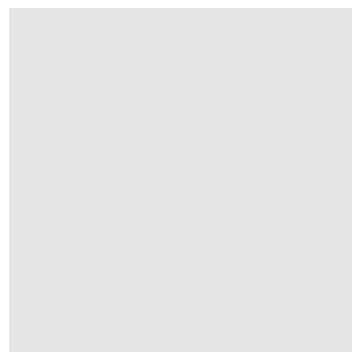

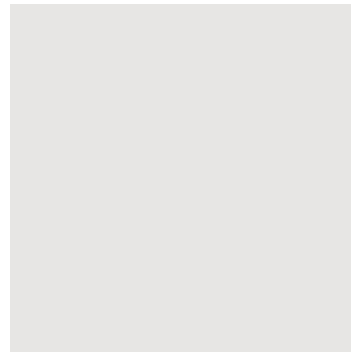
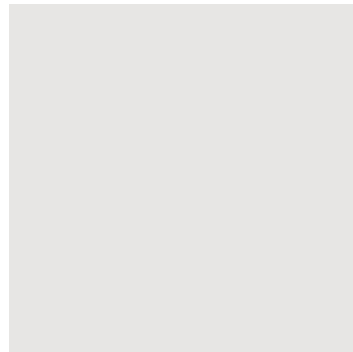
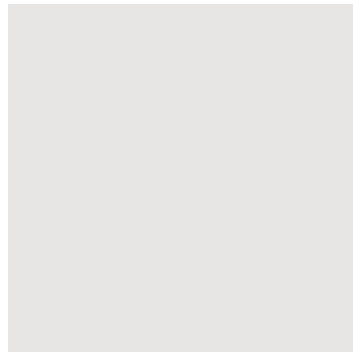
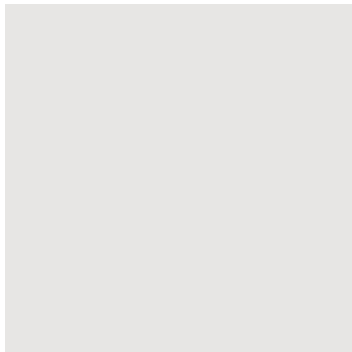
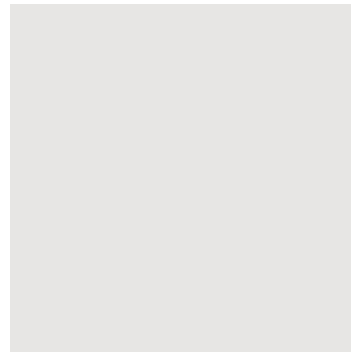
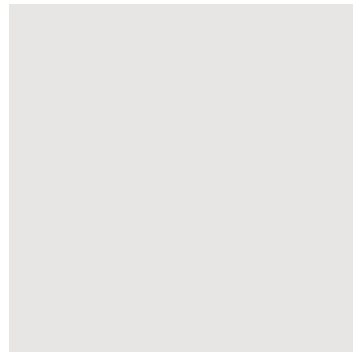
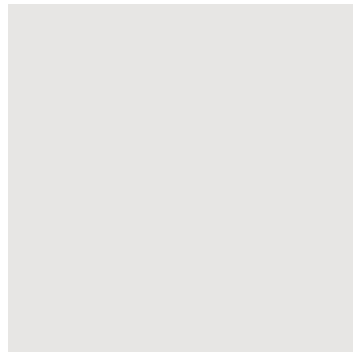
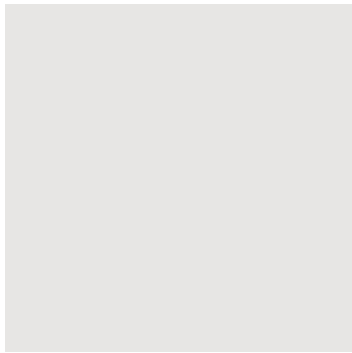
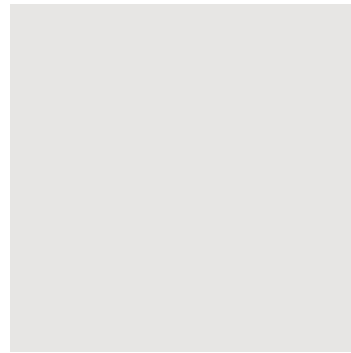
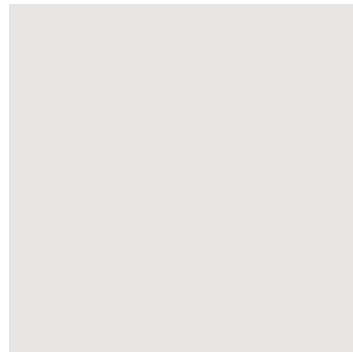
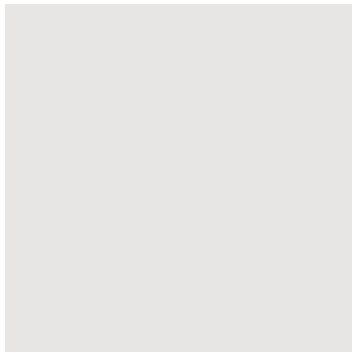
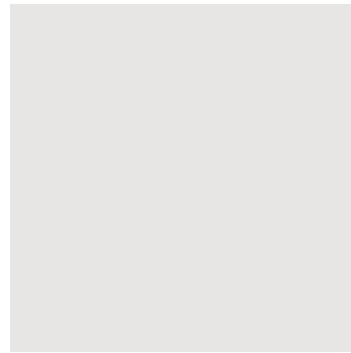
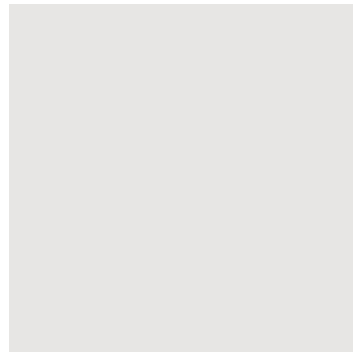
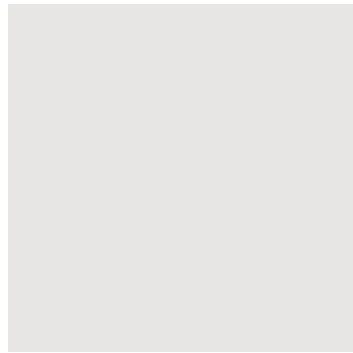
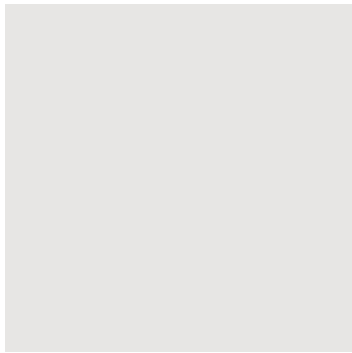
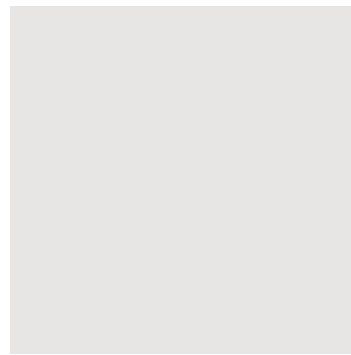
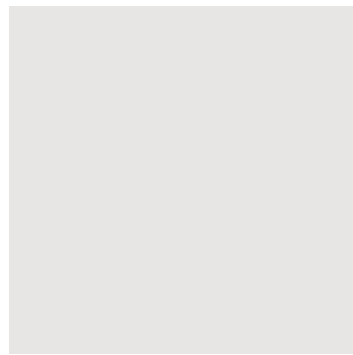
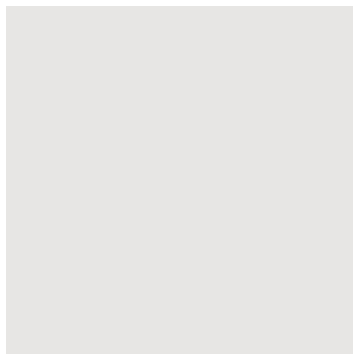





ART.	◆	A	B
▲ 4CN.422.0000 .xx .x		220 (300)*	520 (600)*
🔧 4CN.22J.0000 .xx .x			
🔧 4CN.22Y.0000 .xx .x			
▲ 4CN.422.000M .xx .x		300 (380)*	520 (600)*
🔧 4CN.22J.000M .xx .x			
🔧 4CN.22Y.000M .xx .x			
▲ 4CN.422.000L .xx .x		320 (400)*	720 (800)*
🔧 4CN.22J.000L .xx .x			
🔧 4CN.22Y.000L .xx .x			
▲ 4CN.422.00LA .xx .x		400 (480)*	1160 (1240)*
🔧 4CN.22J.00LA .xx .x			
🔧 4CN.22Y.00LA .xx .x			
4CN.422.5075 .xx .x		500 (580)*	750 (830)*
🔧 4CN.22J.5075 .xx .x			
🔧 4CN.22Y.5075 .xx .x			
4CN.422.9999 .xx .x	⊙		⊙
🔧 4CN.22J.9999 .xx .x			
🔧 4CN.22Y.9999 .xx .x			

ART.	◆	A	B
4CN.422.00LB .xx .x		480 (560)*	1160 (1240)*
🔧 4CN.22J.00LB .xx .x			
🔧 4CN.22Y.00LB .xx .x			
4CN.422.99LB .xx .x	⊙		⊙
🔧 4CN.22J.99LB .xx .x			
🔧 4CN.22Y.99LB .xx .x			

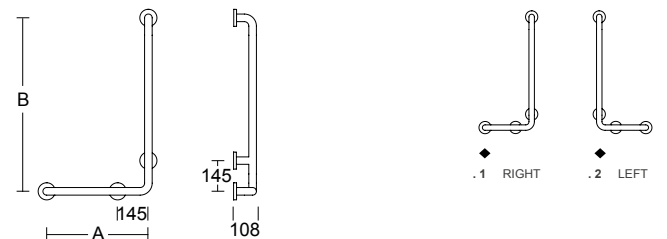

- Sostegno di sicurezza a "L"
- "L"-shaped safety support
- Barre d'appui forme à "L"
- Asidero en "L"



- Sostegno di sicurezza a "L"
- "L"-shaped safety support
- Barre d'appui forme à "L"
- Asidero en "L"



THESE PRODUCTS CONTRIBUTE TO LEED® CREDITS

.XX FINISH	.A1	.01	.02	.03	.04	.05	.07	.09	.10	.17
LRV										
		87	76	65		27	9	5		



- ◆ .1 DESTRO RIGHT DROITE DERECHA
- .2 SINISTRO LEFT GAUCHE IZQUIERDA



ART.	A	B
4CN.433.0000 .xx	1570 (1650)*	820 (900)*
4CN.33J.0000 .xx		
4CN.33Y.0000 .xx		
4CN.433.000L .xx	1570 (1650)*	1160 (1240)*
4CN.33J.000L .xx		
4CN.33Y.000L .xx		
4CN.433.9999 .xx		
4CN.33J.9999 .xx		
4CN.33Y.9999 .xx		

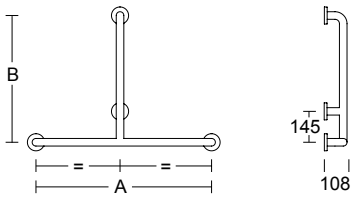

- Sostegno di sicurezza a "T"
- "T"-shaped safety support
- Barre d'appui forme à "T"
- Asidero en "T"



THESE PRODUCTS CONTRIBUTE TO LEED® CREDITS

.XX FINISH	.A1	.01	.02	.03	.04	.05	.07	.09	.10	.17
LRV										
		87	76	65		27	9	5		



ART.	◆	A	B	C
▲ 4CN.424.0000 .xx .x		660 (700)*	660 (700)*	820 (900)*
4CN.24J.0000 .xx .x				
▲ 4CN.424.000L .xx .x		760 (800)*	400 (440)*	1160 (1240)*
4CN.24J.000L .xx .x				
▲ 4CN.424.00LA .xx .x		760 (800)*	760 (800)*	1160 (1240)*
4CN.24J.00LA .xx .x				
4CN.424.9999 .xx .x				
4CN.24J.9999 .xx .x				

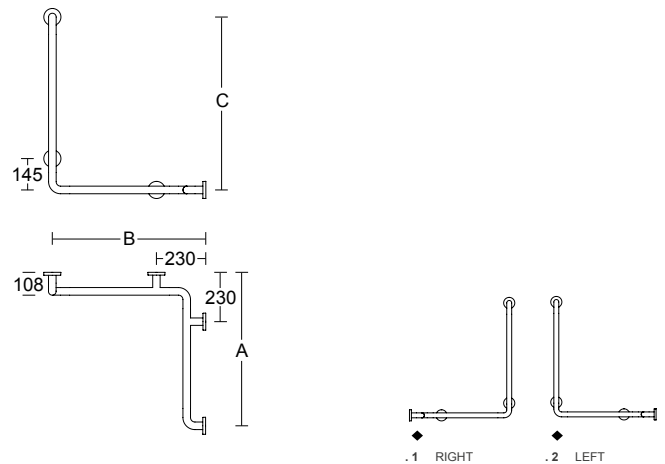

- Sostegno di sicurezza ad angolo con impugnatura verticale
- Corner safety support with shower head rail
- Barre d'appui à coin avec barre de douche
- Asidero en ángulo con empuñadura vertical



◆	.1	DESTRO	RIGHT	DROITE	DERECHA
	.2	SINISTRO	LEFT	GAUCHE	IZQUIERDA



ART.	◆	A	B	C
▲ 4CN.443.000B .xx .x		760 (800)*	760 (800)*	1160 (1240)*
◆ 4CN.43J.000B .xx .x				
▲ 4CN.443.00BL .xx .x		760 (800)*	1185 (1225)*	1160 (1240)*
◆ 4CN.43J.00BL .xx .x				
4CN.443.00BM .xx .x		920 (960)*	920 (960)*	1160 (1240)*
◆ 4CN.43J.00BM .xx .x				
4CN.443.999B .xx .x	Ⓢ			
◆ 4CN.43J.999B .xx .x				

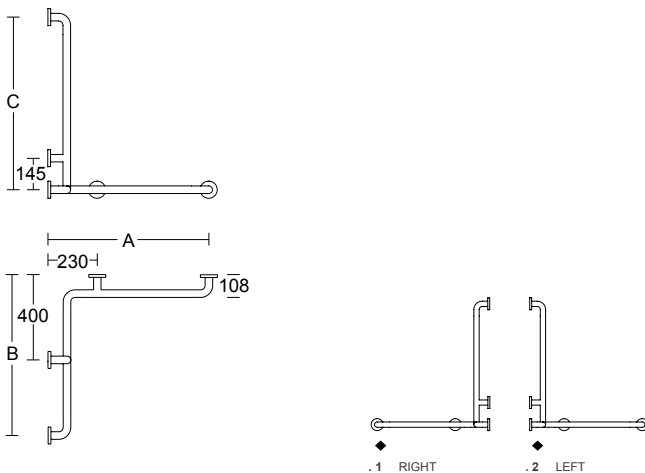

- Sostegno di sicurezza ad angolo con impugnatura verticale
- Corner safety support with shower head rail
- Barre d'appui à coin avec barre de douche
- Asidero en ángulo con empuñadura vertical



ART.	◆	A	B	C
▲ 4CN.443.0000 .xx .x		1160 (1200)*	760 (800)*	820 (900)*
◆ 4CN.43J.0000 .xx .x				
4CN.443.9999 .xx .x	Ⓢ			
◆ 4CN.43J.9999 .xx .x				

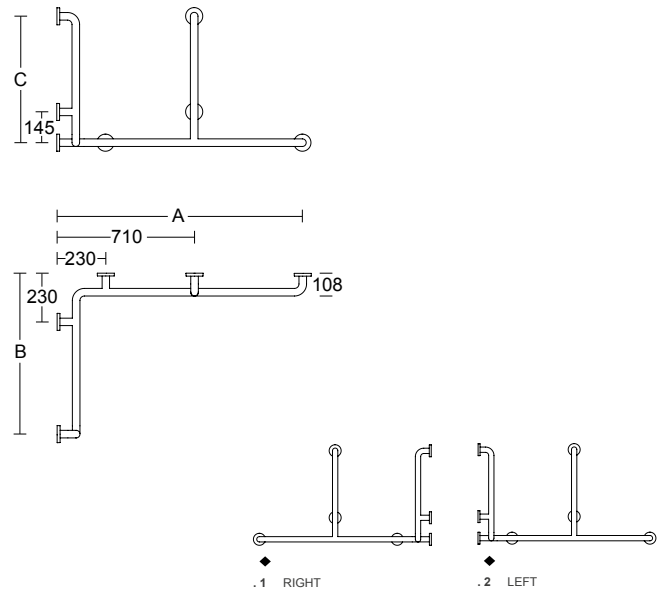

- Sostegno di sicurezza ad angolo con due impugnature verticali
- Corner safety support with two shower head rails
- Barre d'appui à coin avec deux barres de douche
- Asidero en ángulo con dos empuñaduras verticales



THESE PRODUCTS CONTRIBUTE TO LEED® CREDITS

.XX FINISH	.A1	.01	.02	.03	.04	.05	.07	.09	.10	.17
LRV	87	87	76	65	27	9	5			



- ◆ .1 DESTRO RIGHT DROITE DERECHA
- ◆ .2 SINISTRO LEFT GAUCHE IZQUIERDA



ART. A
 4CN.438.0000 .xx 1420 (1500)*
 4CN.438.9999 .xx

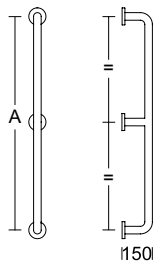

- Sostegno di sicurezza verticale (parete-parete) con supporto intermedio
- Vertical safety support (wall-to-wall) with intermediate wall support
- Barre d'appui verticale (mur-mur) avec support intermédiaire
- Asidero vertical (pared-pared) con soporte intermedio



ART. A
 4CN.438.000B .xx 1860 (1900)*
 4CN.438.999B .xx

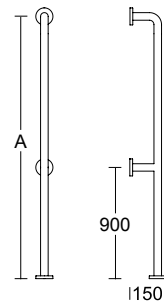

- Sostegno di sicurezza verticale (parete-pavimento) con supporto intermedio
- Vertical safety support (floor-to-wall) with intermediate wall support
- Barre d'appui verticale (mur-sol) avec support intermédiaire
- Asidero vertical (pared-suelo) con soporte intermedio



THESE PRODUCTS CONTRIBUTE TO LEED® CREDITS

.XX FINISH	.A1	.01	.02	.03	.04	.05	.07	.09	.10	.17
LRV										
		87	76	65		27	9	5		





ART.	A
▲ 4CN.487.0000 .xx	570 (650)*
▲ 4CN.487.000A .xx	770 (850)*
▲ 4CN.487.000E .xx	800 (880)*
▲ 4CN.487.000B .xx	970 (1050)*
▲ 4CN.487.000C .xx	1170 (1250)*
4CN.487.9999 .xx	☺

ART.	A	B
4CN.487.00RD .xx	140*	93*

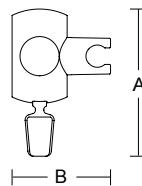
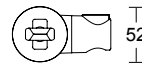
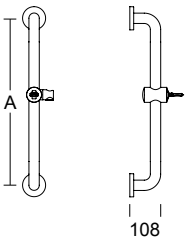

- Sostegno di sicurezza con reggisoffione
- Fixed safety support with shower head holder
- Barre d'appui fixe avec curseur de douchette
- Asidero con soporte para ducha regulable en altura



- Reggisoffione girevole con attacco conico universale a scorrimento compatibile con sostegni di sicurezza del PROGRAMMA 400-NY
- Rotating shower head holder with universal sliding tapered connection compatible with all safety supports of the PROGRAMMA 400-NY
- Curseur de douche rabatable avec élément de fixation mobile et conique universel compatible avec les barres d'appui du PROGRAMMA 400-NY
- Soporte ducha giratorio con base cónica universal deslizable compatible con todos los asideros del PROGRAMA 400-NY

THESE PRODUCTS CONTRIBUTE TO LEED® CREDITS

.XX FINISH	.A1	.01	.02	.03	.04	.05	.07	.09	.10	.17
LRV										
		87	76	65		27	9	5		





ART.	A
▲ 4CN.440.0000 .xx 4CN.40Y.0000 .xx	370 (450)*
▲ 4CN.440.000A .xx 4CN.40Y.000A .xx	570 (650)*
▲ 4CN.440.000E .xx 4CN.40Y.000E .xx	600 (680)*
▲ 4CN.440.000B .xx 4CN.40Y.000B .xx	770 (850)*
▲ 4CN.440.000C .xx 4CN.40Y.000C .xx	970 (1050)*
▲ 4CN.440.000D .xx 4CN.40Y.000D .xx	1170 (1250)*
▲ 4CN.440.000Z .xx 4CN.40Y.000Z .xx	300 (380)*
4CN.440.9999 .xx 4CN.40Y.9999 .xx	Ⓢ

ART.	A
4CN.440.000L .xx 4CN.440.999L .xx	400 (480)* Ⓢ

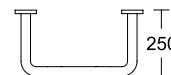
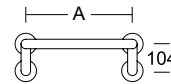
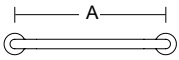

- Sostegno di sicurezza orizzontale
- Horizontal safety support
- Barre d'appui orizzontale
- Asidero horizontal



- Struttura di protezione sifone
- Basin guard rail
- Structure de protégé siphon
- Asidero para protección del sifón

THESE PRODUCTS CONTRIBUTE TO LEED® CREDITS

.XX FINISH	.A1	.01	.02	.03	.04	.05	.07	.09	.10	.17
LRV										
		87	76	65		27	9	5		





ART.	A
▲ 4CN.423.000B .xx	1370 (1450)*
▲ 4CN.423.00BL .xx	1570 (1650)*
4CN.423.999B .xx	Ⓢ

ART.	A
▲ 4CN.442.0000 .xx	760 (800)*
▲ 4CN.442.000M .xx	960 (1000)*
▲ 4CN.442.000L .xx	1160 (1200)*
4CN.442.9999 .xx	Ⓢ

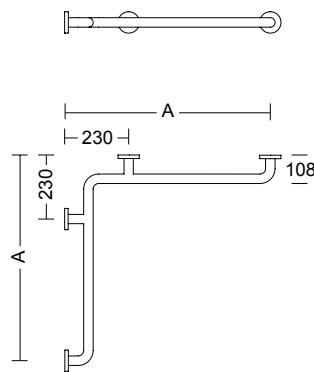
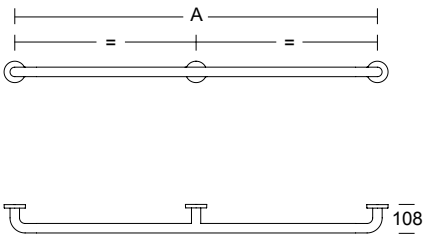

- Sostegno di sicurezza orizzontale con supporto intermedio
- Horizontal safety support with intermediate wall support
- Barre d'appui horizontale avec support intermédiaire
- Asidero horizontal con soporte intermedio



- Sostegno di sicurezza ad angolo simmetrico
- Symmetric corner safety support
- Barre d'appui à coin symétrique
- Asidero en ángulo simétrico



THESE PRODUCTS CONTRIBUTE TO LEED® CREDITS

.XX FINISH	.A1	.01	.02	.03	.04	.05	.07	.09	.10	.17
LRV										
		87	76	65		27	9	5		





◆ LEFT

ART.	A	B
▲ 4CN.442.000B .xx	1060 (1100)*	560 (600)*
▲ 4CN.442.00BL .xx	1760 (1800)*	760 (800)*
4CN.442.999B .xx	☉	☉

ART.	◆	A	B
4CN.428.0000 .xx .x		500	300
4CN.28Y.0000 .xx .x			
4CN.428.9999 .xx .x	☉		☉
4CN.28Y.9999 .xx .x	☉		

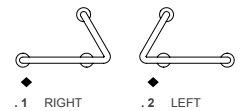
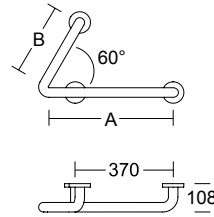
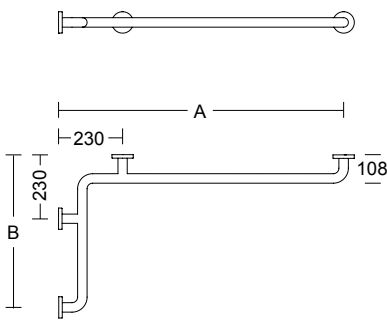

- Sostegno di sicurezza ad angolo asimmetrico
- Asymmetric corner safety support
- Barre d'appui à coin asymétrique
- Asidero en ángulo asimétrico



- Sostegno di sicurezza fisso chiuso
- Closed fixed safety support
- Barre d'appui fixe coudée
- Asidero fijo en ángulo



THESE PRODUCTS CONTRIBUTE TO LEED® CREDITS

.XX FINISH	.A1	.01	.02	.03	.04	.05	.07	.09	.10	.17
LRV	☐	☐	☐	☐	☐	☐	☐	☐	☐	☐
		87	76	65		27	9	5		



- ◆ .1 DESTRO RIGHT DROITE DERECHA
- .2 SINISTRO LEFT GAUCHE IZQUIERDA



ART.	◆	A	B	α
4CN.427.0000 .xx .x		500	300	135° +/- 15°
4CN.27Y.0000 .xx .x				
4CN.427.9999 .xx .x	Ⓢ			135° +/- 15°
4CN.27Y.9999 .xx .x				
4CN.427.000F .xx .x		500	300	135°
4CN.27Y.000F .xx .x				
4CN.427.999F .xx .x	Ⓢ			135°
4CN.27Y.999F .xx .x				

ART.	◆	A	B
4CN.427.00FC .xx .x		300	200
4CN.27Y.00FC .xx .x			
4CN.427.99FC .xx .x	Ⓢ		
4CN.27Y.99FC .xx .x			

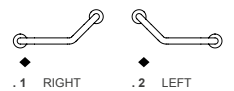
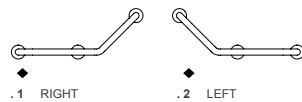
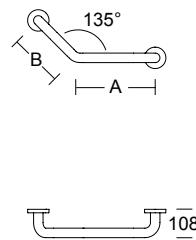
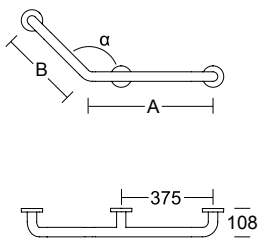

- Sostegno di sicurezza fisso aperto
- Open fixed safety support
- Barre d'appui fixe coudée
- Asidero fijo en ángulo



- Sostegno di sicurezza fisso aperto
- Open fixed safety support
- Barre d'appui fixe coudée
- Asidero fijo en ángulo



THESE PRODUCTS CONTRIBUTE TO LEED® CREDITS

.XX FINISH	.A1	.01	.02	.03	.04	.05	.07	.09	.10	.17
LRV	87	76	65	27	9	5				



- ◆ .1 DESTRO RIGHT DROITE DERECHA
- .2 SINISTRO LEFT GAUCHE IZQUIERDA



ART.	A	B
4CN.427.00FD .xx	400	400

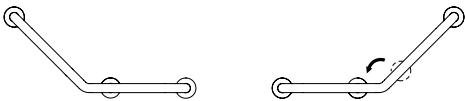
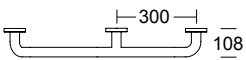
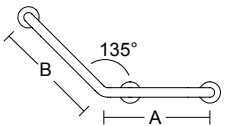

- Sostegno di sicurezza fisso aperto con supporto intermedio, intercambiabile DX - SX
- Open fixed safety support with intermediate support, interchangeable R-L
- Barre d'appui fixe coudée avec support intermédiaire, interchangeable D-G
- Asidero fijo en ángulo con soporte intermedio intercambiabile D - I



THESE PRODUCTS CONTRIBUTE TO LEED® CREDITS

.XX FINISH	.A1	.01	.02	.03	.04	.05	.07	.09	.10	.17
LRV										
		87	76	65		27	9	5		



ART.	A
▲ 4CN.441.000P .xx	600*
▲ 4CN.441.00PL .xx	700*
▲ 4CN.441.0PLL .xx	850*

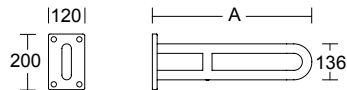

- Sostegno di sicurezza fisso su piastra
- Safety support fixed on plate
- Barre d'appui fixe sur plaque
- Asidero fijo sobre placa





ART.	A
4CN.441.00PA .xx	600*
4CN.441.0PLA .xx	700*
4CN.441.PLLA .xx	850*

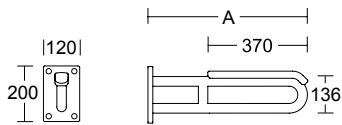

- Sostegno di sicurezza fisso su piastra con appoggiabraccio
- Safety support fixed on plate with armrest
- Barre d'appui fixe sur plaque avec accoudoir
- Asidero fijo sobre placa con apoyabrazos



THESE PRODUCTS CONTRIBUTE TO LEED® CREDITS

.XX FINISH	.A1	.01	.02	.03	.04	.05	.07	.09	.10	.17
LRV										
		87	76	65		27	9	5		





ART.	A
▲ 4CN.445.00RT .xx	600*
▲ 4CN.45Y.00RT .xx	
▲ 4CN.45K.00RT .xx	
▲ 4CN.445.000R .xx	700*
▲ 4CN.45Y.000R .xx	
▲ 4CN.45K.000R .xx	
▲ 4CN.445.00RL .xx	850*
▲ 4CN.45Y.00RL .xx	
▲ 4CN.45K.00RL .xx	

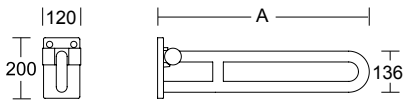

- Sostegno di sicurezza ribaltabile con frizione regolabile
- Lift-up safety support with friction device
- Barre d'appui relevable avec dispositif de friction
- Asidero abatible con embrague regulable



ART.	A
4CN.445.00RTA .xx	600*
4CN.45Y.00RTA .xx	
4CN.45K.00RTA .xx	
4CN.445.00RA .xx	700*
4CN.45Y.00RA .xx	
4CN.45K.00RA .xx	
4CN.445.00RLA .xx	850*
4CN.45Y.00RLA .xx	
4CN.45K.00RLA .xx	

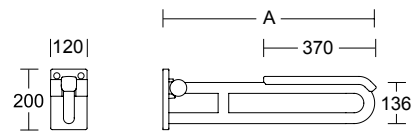

- Sostegno di sicurezza ribaltabile con frizione regolabile e appoggiabraccio
- Lift-up safety support with friction device and armrest
- Barre d'appui relevable avec dispositif de friction et accoudoir
- Asidero abatible con embrague regulable y apoyabrazos



THESE PRODUCTS CONTRIBUTE TO LEED® CREDITS

.XX FINISH	.A1	.01	.02	.03	.04	.05	.07	.09	.10	.17
LRV										
		87	76	65		27	9	5		



ART.	A
▲ 4CN.445.0RGT .xx	600*
▲ 4CN.45Y.0RGT .xx	
▲ 4CN.45K.0RGT .xx	
▲ 4CN.445.00RG .xx	700*
▲ 4CN.45Y.00RG .xx	
▲ 4CN.45K.00RG .xx	
▲ 4CN.445.0RGL .xx	850*
▲ 4CN.45Y.0RGL .xx	
▲ 4CN.45K.0RGL .xx	

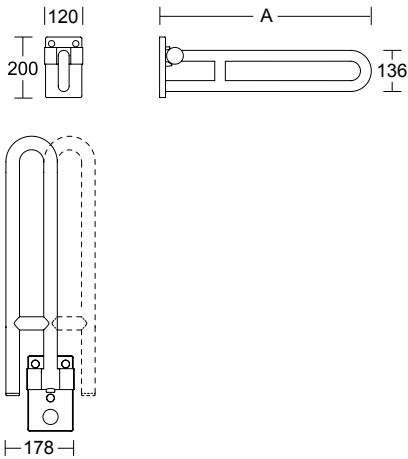

- Sostegno di sicurezza ribaltabile e girevole con frizione regolabile
- Rotating lift-up safety support with friction device
- Barre d'appui relevable et rabatable avec dispositif de friction
- Asidero abatible y giratorio con embrague regulable



ART.	A
4CN.445.RGTA .xx	600*
4CN.45Y.RGTA .xx	
4CN.45K.RGTA .xx	
4CN.445.0RGA .xx	700*
4CN.45Y.0RGA .xx	
4CN.45K.0RGA .xx	
4CN.445.RGLA .xx	850*
4CN.45Y.RGLA .xx	
4CN.45K.RGLA .xx	

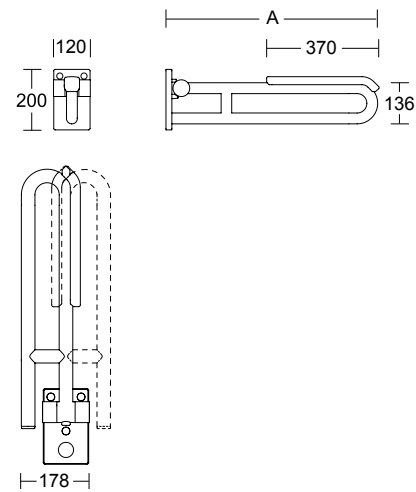

- Sostegno di sicurezza ribaltabile e girevole con frizione regolabile e appoggiabraccio
- Rotating lift-up safety support with friction device and armrest
- Barre d'appui relevable et rabatable avec dispositif de friction et accouidoir
- Asidero abatible y giratorio con embrague regulable y apoyabrazos



THESE PRODUCTS CONTRIBUTE TO LEED® CREDITS

.XX FINISH	.A1	.01	.02	.03	.04	.05	.07	.09	.10	.17
LRV										
		87	76	65		27	9	5		



ART.	A
4CN.445.0RTE .xx	600*
4CN.45Y.0RTE .xx	
4CN.45K.0RTE .xx	
4CN.445.00RE .xx	700*
4CN.45Y.00RE .xx	
4CN.45K.00RE .xx	
4CN.445.0RLE .xx	850*
4CN.45Y.0RLE .xx	
4CN.45K.0RLE .xx	

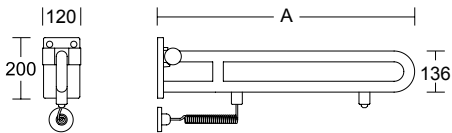

- Sostegno di sicurezza ribaltabile con frizione regolabile e comando elettrico
- Lift-up safety support with friction device and electrical push button
- Barre d'appui relevable avec dispositif de friction et bouton-poussoir électrique
- Asidero abatible con embrague regulable y botón eléctrico



THESE PRODUCTS CONTRIBUTE TO LEED® CREDITS

.XX FINISH	.A1	.01	.02	.03	.04	.05	.07	.09	.10	.17
LRV										
		87	76	65		27	9	5		



ART.	A
4CN.445.RTAE .xx	600*
4CN.45Y.RTAE .xx	
4CN.45K.RTAE .xx	
4CN.445.0RAE .xx	700*
4CN.45Y.0RAE .xx	
4CN.45K.0RAE .xx	
4CN.445.RLAE .xx	850*
4CN.45Y.RLAE .xx	
4CN.45K.RLAE .xx	

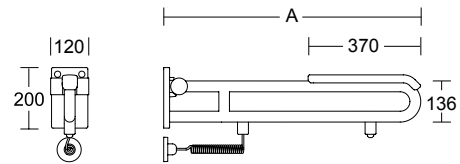

- Sostegno di sicurezza ribaltabile con frizione regolabile, appoggiabraccio e comando elettrico
- Lift-up safety support with friction device, armrest and electrical push button
- Barre d'appui relevable avec dispositif de friction, accoudoir et bouton-poussoir électrique
- Asidero abatible con embrague regulable con apoyabrazos y botón eléctrico





ART.	A
4CN.445.RGTE .xx	600*
4CN.45Y.RGTE .xx	
4CN.45K.RGTE .xx	
4CN.445.0RGE .xx	700*
4CN.45Y.0RGE .xx	
4CN.45K.0RGE .xx	
4CN.445.RGLE .xx	850*
4CN.45Y.RGLE .xx	
4CN.45K.RGLE .xx	

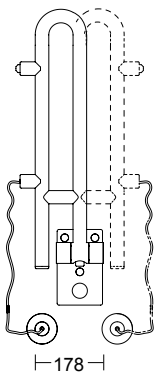
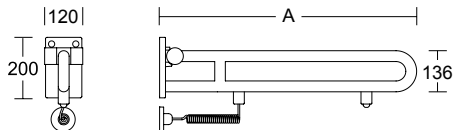

- Sostegno di sicurezza ribaltabile e girevole con frizione regolabile e comando elettrico
- Rotating lift-up safety support with friction device and electrical push button
- Barre d'appui relevable et rabattable avec dispositif de friction et bouton-poussoir électrique
- Asidero abatible giratorio con embrague regulable y botón eléctrico



THESE PRODUCTS CONTRIBUTE TO LEED® CREDITS

.XX FINISH	.A1	.01	.02	.03	.04	.05	.07	.09	.10	.17
LRV										
		87	76	65		27	9	5		



ART.	A
4CN.445.RGTO .xx	600*
4CN.45Y.RGTO .xx	
4CN.45K.RGTO .xx	
4CN.445.0RGO .xx	700*
4CN.45Y.0RGO .xx	
4CN.45K.0RGO .xx	
4CN.445.RGLO .xx	850*
4CN.45Y.RGLO .xx	
4CN.45K.RGLO .xx	

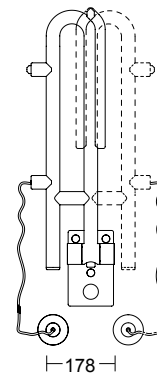
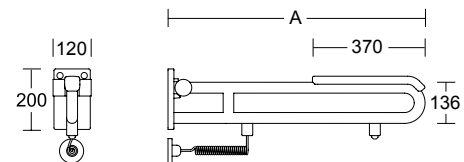

- Sostegno di sicurezza ribaltabile e girevole con frizione regolabile, appoggiabraccio e comando elettrico
- Rotating lift-up safety support with friction device, armrest and electrical push button
- Barre d'appui relevable et rabattable avec dispositif de friction, accoudoir et bouton-poussoir électrique
- Asidero abatible giratorio con embrague regulable, con apoyabrazos y botón eléctrico





ART.	A
4CN.45Z.0RTE .xx	600*
4CN.45Z.00RE .xx	700*
4CN.45Z.0RLE .xx	850*

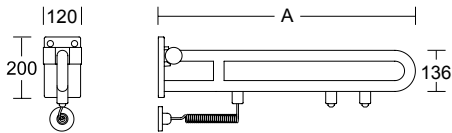

- Sostegno di sicurezza ribaltabile con frizione regolabile e doppio comando elettrico
- Lift-up safety support with friction device and double electrical push button
- Barre d'appui relevable avec dispositif de friction et bouton-poussoir électrique double
- Asidero abatible con embrague regulable y botón eléctrico doble



THESE PRODUCTS CONTRIBUTE TO LEED® CREDITS

.XX FINISH	.A1	.01	.02	.03	.04	.05	.07	.09	.10	.17
LRV										
		87	76	65		27	9	5		



ART.	A
4CN.45Z.RGTE .xx	600*
4CN.45Z.0RGE .xx	700*
4CN.45Z.RGLE .xx	850*

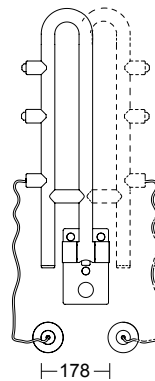
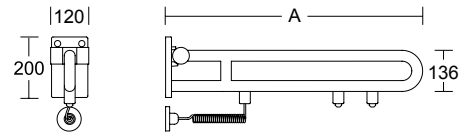

- Sostegno di sicurezza ribaltabile e girevole con frizione regolabile e doppio comando elettrico
- Rotating lift-up safety support with friction device and double electrical push button
- Barre d'appui relevable et rabattable avec dispositif de friction et bouton-poussoir électrique double
- Asidero abatible giratorio con embrague regulable y botón eléctrico doble





ART.	A
▲ 4CN.445.00CT .xx	605*
▲ 4CN.445.000C .xx	705*
▲ 4CN.445.00CL .xx	855*

ART.	A
4CN.445.0CTA .xx	605*
4CN.445.00CA .xx	705*
4CN.445.0CLA .xx	855*

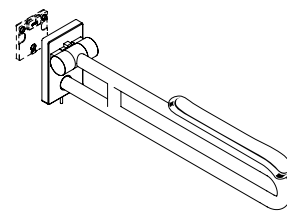
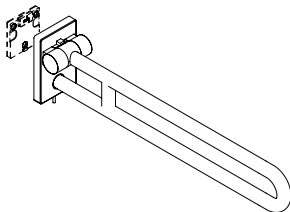
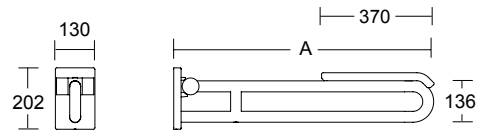
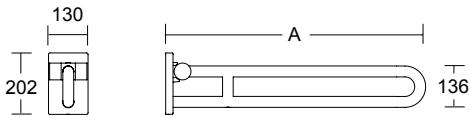

- Sostegno di sicurezza ribaltabile estraibile
- Extractable lift-up safety support
- Barre d'appui relevable amovible
- Asidero abatible y extraible



- Sostegno di sicurezza ribaltabile estraibile e appoggiabraccio
- Extractable lift-up safety support and armrest
- Barre d'appui relevable amovible et accoudoir
- Asidero abatible, extraible y apoyabrazos



THESE PRODUCTS CONTRIBUTE TO LEED® CREDITS

.XX FINISH	.A1	.01	.02	.03	.04	.05	.07	.09	.10	.17
LRV										
		87	76	65		27	9	5		

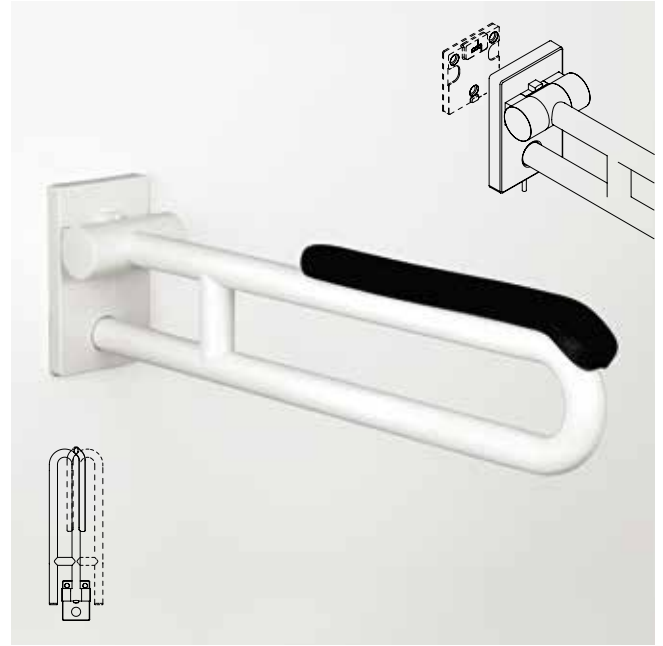
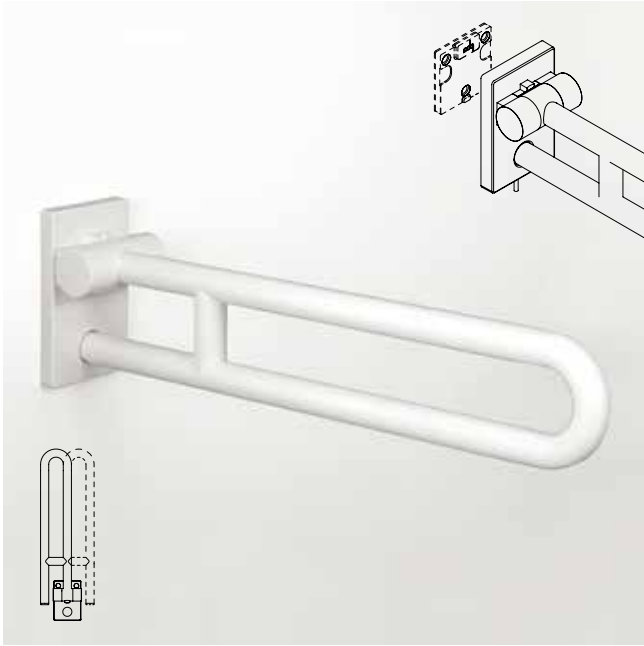

ART.	A
▲ 4CN.445.0CGT .xx	605*
▲ 4CN.445.00CG .xx	705*
▲ 4CN.445.0CGL .xx	855*

ART.	A
4CN.445.CGTA .xx	605*
4CN.445.0CGA .xx	705*
4CN.445.CGLA .xx	855*

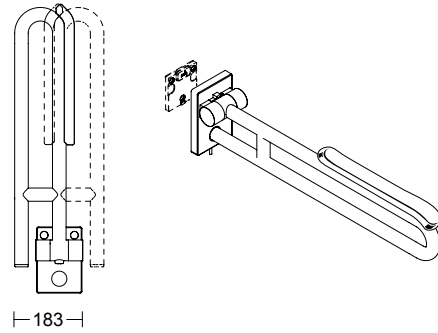
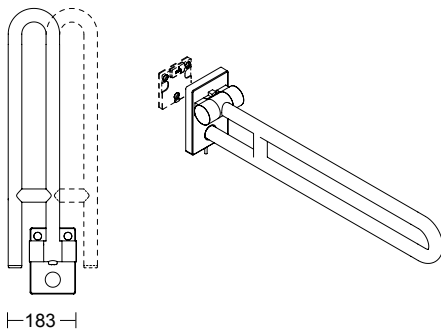
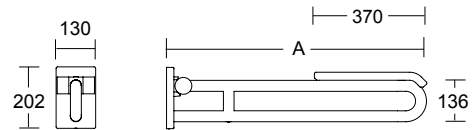
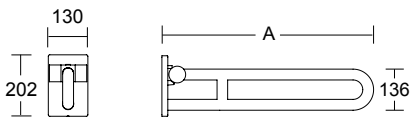

- Sostegno di sicurezza ribaltabile, estraibile e girevole
- Extractable lift-up rotating safety support
- Barre d'appui relevable amovible et rabattable
- Asidero abatible, extraible y giratorio



- Sostegno di sicurezza ribaltabile, estraibile e girevole con appoggiabraccio
- Extractable lift-up rotating safety support and armrest
- Barre d'appui relevable amovible et rabattable avec accoudoir
- Asidero abatible, extraible y giratorio con apoyabrazos



THESE PRODUCTS CONTRIBUTE TO LEED® CREDITS

.XX FINISH	.A1	.01	.02	.03	.04	.05	.07	.09	.10	.17
LRV	100	87	76	65	55	45	27	9	5	3



ART.
4CN.445.0CPM.00

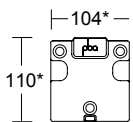

- Placca a muro per sostegno di sicurezza ribaltabile estraibile
- Wall plate for extractable Lift-up safety support
- Plaque murale pour barre d'appui relevable amovible
- Placa en pared del asidero abatible y extraíble



ART.
4CN.445.0CCP .xx

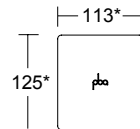

- Coperchio per placca a muro del sostegno di sicurezza ribaltabile estraibile
- Cover for wall plate of the extractable Lift-up safety support
- Couverture pour la plaque murale de la barre d'appui relevable amovible
- Tapa embellecedora para la placa en pared del asidero abatible y extraíble

THESE PRODUCTS CONTRIBUTE TO LEED® CREDITS

.XX FINISH	.A1	.01	.02	.03	.04	.05	.07	.09	.10	.17
LRV										
		87	76	65			27	9	5	



ART.	A	B	C
4CN.445.0RPT .xx	615	850*	685*
4CN.45Y.0RPT .xx			
4CN.445.00RP .xx	715	850*	785*
4CN.45Y.00RP .xx			
4CN.445.0RPL .xx	865	850*	935*
4CN.45Y.0RPL .xx			

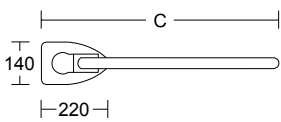
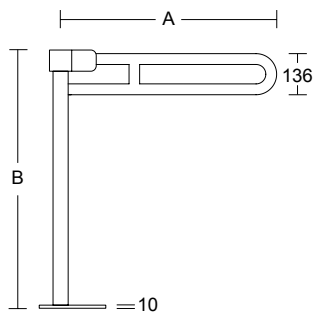

- Sostegno di sicurezza ribaltabile su piantana a pavimento
- Lift-up safety support with floor stand
- Barre d'appui relevable avec fixation au sol
- Asidero abatible con soporte al suelo



ART.	A	B	C
4CN.445.RPTA .xx	615	850*	685*
4CN.45Y.RPTA .xx			
4CN.445.0RPA .xx	715	850*	785*
4CN.45Y.0RPA .xx			
4CN.445.RPLA .xx	865	850*	935*
4CN.45Y.RPLA .xx			

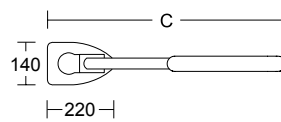
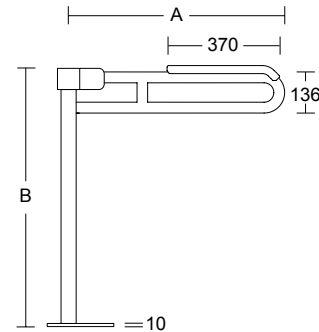

- Sostegno di sicurezza ribaltabile su piantana a pavimento con appoggiabraccio
- Lift-up safety support with floor stand and armrest
- Barre d'appui relevable fixation au sol et accoudoir
- Asidero abatible con soporte al suelo y apoyabrazos



THESE PRODUCTS CONTRIBUTE TO LEED® CREDITS

.XX FINISH	.A1	.01	.02	.03	.04	.05	.07	.09	.10	.17
LRV	87	76	65	27	9	5				



ART.	A	B	C
4CN.434.0000 . xx	490 (570)*	210*	200*
4CN.434.000R . xx	490 (570)* - 620 (700)*	210*	195*

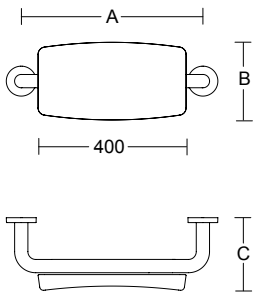

- Appoggiaschiena da WC
- WC Backrest
- Appui dos pour WC
- Respaldo de WC



ART.	A	B	C
4CN.434.000L . xx	700 (736)*	210*	141*
4CN.434.00RL . xx	650 (686)* - 780 (816)*	210*	141*

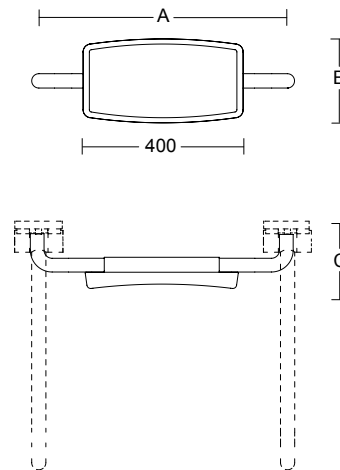

- Appoggiaschiena regolabile da fissare tra due sostegni di sicurezza ribaltabili 4CN.445.00XX
- WC Adjustable backrest to be fixed between two folding safety supports 4CN.445.00XX
- Appui dos réglable pour WC à fixer entre deux barres d'appui relevables 4CN.445.00XX
- Respaldo ajustable para montar entre dos asideros abatibles 4CN.445.00XX



THESE PRODUCTS CONTRIBUTE TO LEED® CREDITS

.XX FINISH	.A1	.01	.02	.03	.04	.05	.07	.09	.10	.17
LRV										
		87	76	65		27		9	5	



◆ LEFT

ART.	◆	A	A1	A2
4CN.434.0RRL .xx.x		480 (538)* - 620 (678)*	240 - 310	240 - 310

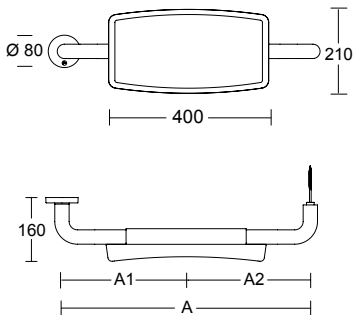

- Appoggiaschiena regolabile da fissare a sostegno di sicurezza ribaltabile 4CN.445.00XX e con rosetta a parete
- WC Adjustable backrest to be fixed on a folding safety support 4CN.445.00XX and with wall fixing
- Appui dos réglable pour WC à fixer sur la barre d'appui relevable 4CN.445.00XX et avec fixation murale
- Respaldo ajustable para montar en asidero abatible 4CN.445.00XX y con fijación a pared



THESE PRODUCTS CONTRIBUTE TO LEED® CREDITS

.XX FINISH	.A1	.01	.02	.03	.04	.05	.07	.09	.10	.17
LRV										
		87	76	65		27	9	5		



ART.	A
4CN.445.0RTV .xx	600*
4CN.445.00RV .xx	700*
4CN.445.0RLV .xx	850*

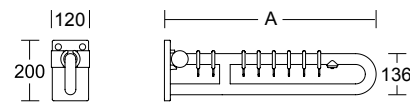

- Sostegno di sicurezza ribaltabile con anelli reggitenda, con frizione regolabile
- Lift-up safety support with shower curtain rings and friction device
- Barre d'appui relevable avec anneaux pour rideau de douche et dispositif de friction
- Asidero abatible con anillas para cortina y embrague regulable



- ◆
- .1 DESTRO RIGHT DROITE DERECHA
- .2 SINISTRO LEFT GAUCHE IZQUIERDA



ART. A
4CN.469.0000 .xx 820*

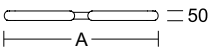
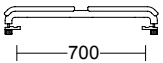

- Barra di sicurezza rimovibile
- Removable safety support
- Barre d'appui amovibile
- Asidero desmontable



ART.
4CN.0RC.0000.00

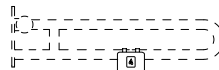

- Radiocomando per sistema elettronico di suono di emergenza e/o scarico dell'acqua WC
- Remote control for automatic WC-flushing system and/or emergency call
- Radiocommande pour système électronique d'évacuation de l'eau du WC et/ou appel d'urgence
- Control remoto electrónico para llamada de emergencia y/o la descarga de agua del WC



THESE PRODUCTS CONTRIBUTE TO LEED® CREDITS

.XX FINISH	.A1	.01	.02	.03	.04	.05	.07	.09	.10	.17
LRV										
		87	76	65		27	9	5		



ART.

4CN.0RC.002C.00

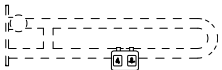

- Radiocomando per sistema elettronico di suono di emergenza e scarico dell'acqua WC
- Remote control for automatic WC-flushing system and emergency call
- Radiocommande pour système électronique d'évacuation de l'eau du WC et appel d'urgence
- Control remoto electrónico para llamada de emergencia y la descarga de agua del WC



THESE PRODUCTS CONTRIBUTE TO LEED® CREDITS





ART.	A	B
▲ 4CN.447.000B .xx	380*	400*
■ 4CN.47K.000B .xx	380*	400*

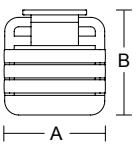
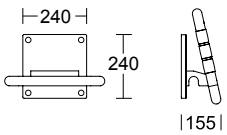

- Seggiolino ribaltabile
- Lift-up shower seat
- Siège relevable
- Asiento abatible



ART.	A	B
4CN.447.0000 .xx	380*	445*

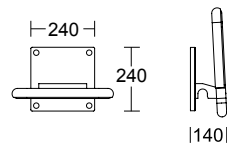

- Seggiolino ribaltabile con foro
- Lift-up seat with elliptic hole
- Siège relevable avec trou elliptique
- Asiento abatible con orificio higiénico central



THESE PRODUCTS CONTRIBUTE TO LEED® CREDITS

.XX FINISH	.A1	.01	.02	.03	.04	.05	.07	.09	.10	.17
LRV										
		87	76	65		27	9	5		



◆ LEFT

ART.	◆	A	B
4CN.447.00BD .xx .x		840*	568*

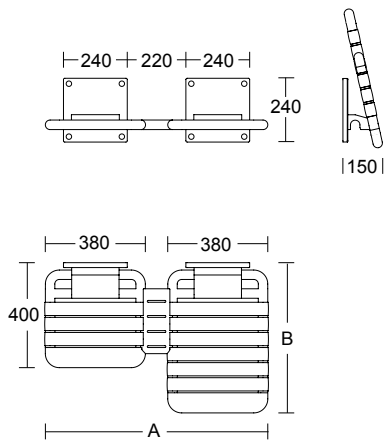

- Seggiolino ribaltabile doppio
- Double lift-up seat
- Siège relevable double
- Asiento abatible doble



ART.	A	B
▲ 4CN.447.00BL .xx	445*	400*
■ 4CN.47K.00BL .xx	445*	400*

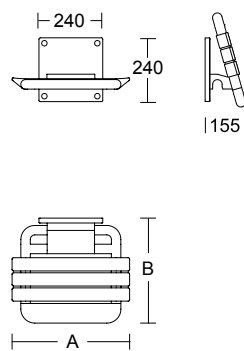

- Seggiolino ribaltabile con seduta larga
- Large lift-up seat
- Siège relevable large
- Asiento abatible grande



THESE PRODUCTS CONTRIBUTE TO LEED® CREDITS

.XX FINISH	.A1	.01	.02	.03	.04	.05	.07	.09	.10	.17
LRV										
		87	76	65		27	9	5		

- ◆ .1 DESTRO RIGHT DROITE DERECHA
- .2 SINISTRO LEFT GAUCHE IZQUIERDA



ART.	A	B
▲ 4CN.447.00BS .xx	530*	400*
■ 4CN.47K.00BS .xx	530*	400*

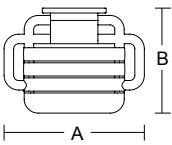
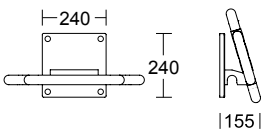

- Seggiolino ribaltabile con maniglie
- Lift-up seat with handles
- Siège relevable avec poignées
- Asiento abatible con agarraderas



PBA
PATENTED
DESIGN

PATENTI
PD2014C000001

ART.	A	B
4CN.447.00CM .xx	400*	415*
■ 4CN.47K.00CM .xx	400*	415*

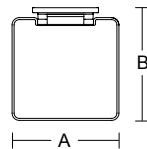
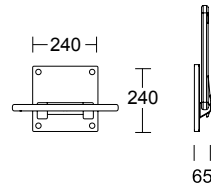

- Seggiolino ribaltabile in nylon con seduta morbida
- Lift-up nylon shower seat with soft seat
- Siège relevable en nylon avec assise souple
- Asiento abatible de nylon con superficie mullida



THESE PRODUCTS CONTRIBUTE TO LEED® CREDITS

.XX FINISH	.A1	.01	.02	.03	.04	.05	.07	.09	.10	.17
LRV										
		87	76	65		27	9	5		



ART.	A	B
4CN.448.0000 .xx	380	740*
4CN.448.000B .xx	380	800*



ART.	A	B	C
▲ 4CN.446.000B .xx	380*	485*	375*
▲ 4CN.446.00BL .xx	380*	485*	440*

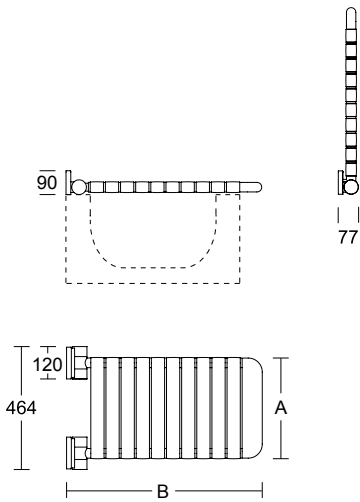

- Seggiolino ribaltabile per vasca
- Lift-up seat for bathtub
- Siège de baignoire relevable
- Asiento abatible para bañera

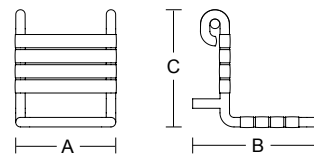

- Seggiolino da agganciare a sostegno di sicurezza
- Suspend seat
- Siège à suspendre
- Asiento suspendido



THESE PRODUCTS CONTRIBUTE TO LEED® CREDITS

.XX FINISH	.A1	.01	.02	.03	.04	.05	.07	.09	.10	.17
LRV										
		87	76	65		27	9	5		



ART.	A	B	C
▲ 4CN.446.00BC .xx	445*	485*	375*
▲ 4CN.446.0BLC .xx	445*	485*	440*

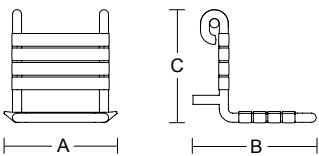

- Seggiolino da agganciare con seduta larga
- Large suspended seat
- Siège à suspendre large
- Asiento suspendido grande



ART.	A	B	C
4CN.449.000B .xx	380*	480*	430*

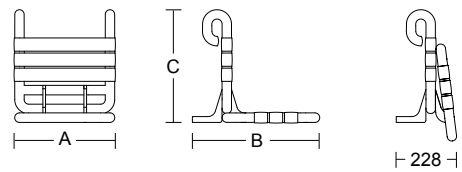

- Seggiolino agganciabile e ribaltabile
- Lift-up suspended seat
- Siège à suspendre et relevable
- Asiento suspendido y abatible



THESE PRODUCTS CONTRIBUTE TO LEED® CREDITS

.XX FINISH	.A1	.01	.02	.03	.04	.05	.07	.09	.10	.17
LRV										
		87	76	65		27	9	5		



ART.	A	B	C
4CN.449.00BL .xx	383*	482*	463*

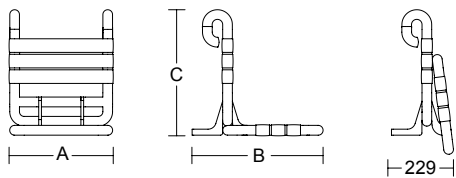

- Seggiolino agganciabile e ribaltabile
- Lift-up suspended seat
- Siège à suspendre et relevable
- Asiento suspendido y abatible



ART.	A	B	C
4CN.449.0BPA .xx	380	480*	415*

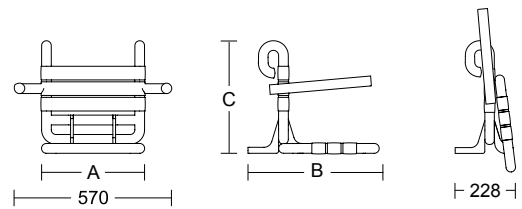

- Seggiolino agganciabile e ribaltabile con braccioli reclinabili
- Lift-up suspended seat with lift-up armrests
- Siège à suspendre et relevable avec accoudoirs relevables
- Asiento suspendido y abatible con brazos reclinables



THESE PRODUCTS CONTRIBUTE TO LEED® CREDITS

.XX FINISH	.A1	.01	.02	.03	.04	.05	.07	.09	.10	.17
LRV										
		87	76	65		27	9	5		



ART.	A	B	C
4CN.446.0BPA .xx	380	485*	415*

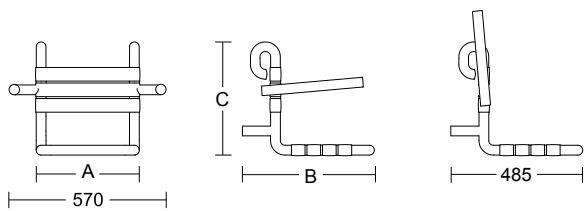

- Seggiolino agganciabile con braccioli reclinabili
- Suspended seat with lift-up armrests
- Siège à suspendre avec accoudoirs relevables
- Asiento suspendido con brazos reclinables



ART.	A	B	C
4CN.447.000F .xx	536*	555*	680*

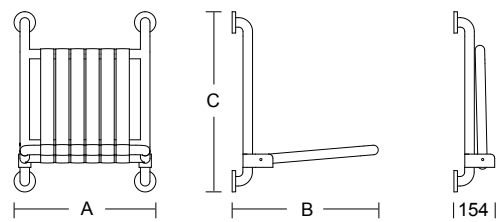

- Seggiolino ribaltabile con schienale fisso a muro
- Lift-up seat with wall-fixed backrest
- Siège relevable avec dossier fixé au mur
- Asiento abatible con respaldo fijo en la pared



THESE PRODUCTS CONTRIBUTE TO LEED® CREDITS

.XX FINISH	.A1	.01	.02	.03	.04	.05	.07	.09	.10	.17
LRV										
		87	76	65	27	9	5			



ART.	A	B	C
4CN.447.00FT .xx	536*	550*	680*

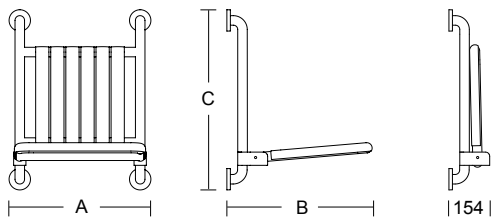

- Seggiolino reclinabile con seduta forata
- Lift-up seat with elliptic hole
- Siège relevable avec trou elliptique
- Asiento abatible con orificio higiénico central



ART.	A	B	C
4CN.455.0000 .xx	380*	380*	495*

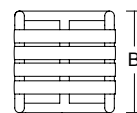
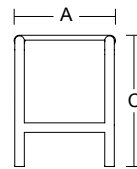











- Sgabello
- Stool
- Tabouret
- Taburete





THESE PRODUCTS CONTRIBUTE TO LEED® CREDITS

.XX FINISH	.A1	.01	.02	.03	.04	.05	.07	.09	.10	.17
LRV										
		87	76	65		27	9	5		

.XX FINISH	.A1	.01	.02	.03	.04	.05	.07	.09	.10	.17
LRV										
		87	76		65		27	9	5	







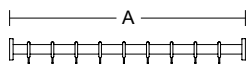







ART.	A	
4CN.429.0000 .xx	800*	8
4CN.429.000A .xx	900*	9
4CN.429.000B .xx	1000*	10
4CN.429.000C .xx	1100*	11
4CN.429.000D .xx	1200*	12
4CN.429.000E .xx	1300*	13
4CN.429.000F .xx	1500*	15
4CN.429.000G .xx	1700*	17
4CN.429.9999 .xx		





- Reggitenda dritto
- Straight shower curtain rail
- Barre de rideau de douche droit
- Barra de cortina de ducha recta

THESE PRODUCTS CONTRIBUTE TO LEED® CREDITS

.XX FINISH	.A1	.01	.02	.03	.04	.05	.07	.09	.10	.17
LRV										
		87	76	65		27		9	5	



ART.	A	B	
4CN.436.0000 .xx	800 (840)*	800 (840)*	16
4CN.436.9999 .xx			

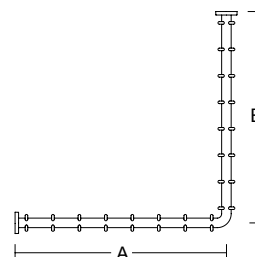
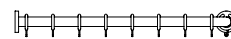

- Reggitenda angolare
- Corner shower curtain rail
- Barre de rideau de douche à coin
- Barra de cortina de ducha en ángulo







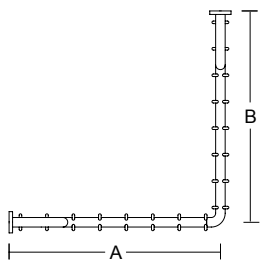
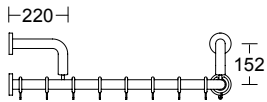

ART.	A	B	
4CN.436.00PP .xx	800 (840)*	800 (840)*	16
4CN.436.99PP .xx			



- Reggitenda angolare con due supporti a muro
- Corner shower curtain rail with two wall supports
- Barre de rideau de douche à coin avec deux supports murales
- Barra de cortina de ducha en ángulo con dos soportes en pared





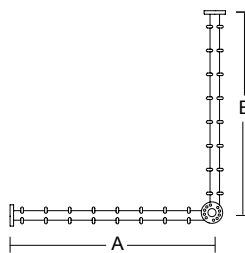
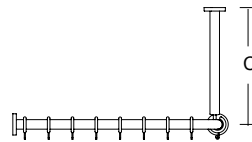





ART.	A	B	C	
4CN.436.000B .xx	800 (840)*	800 (840)*	440 (480)*	16
4CN.436.00BA .xx	900 (940)*	900 (940)*	440 (480)*	18
4CN.436.00BB .xx	1000 (1040)*	1000 (1040)*	440 (480)*	20
4CN.436.00BC .xx	1200 (1240)*	1200 (1240)*	440 (480)*	24
4CN.436.00BD .xx	1500 (1540)*	1500 (1540)*	440 (480)*	30
4CN.436.999B .xx				



- Reggitenda angolare con supporto a soffitto
- Corner shower curtain rail with ceiling support
- Barre de rideau de douche à coin avec support plafond
- Barra de cortina de ducha en ángulo con soporte de techo

THESE PRODUCTS CONTRIBUTE TO LEED® CREDITS

.XX FINISH	.A1	.01	.02	.03	.04	.05	.07	.09	.10	.17
LRV										
		87	76	65		27	9	5		





ART.	A	B	C	⊙
4CN.437.0000 .xx	800 (840)*	800 (880)*	440 (480)*	24
4CN.437.000A .xx	1000 (1040)*	1000 (1080)*	440 (480)*	30
4CN.437.9999 .xx	⊙	⊙	⊙	

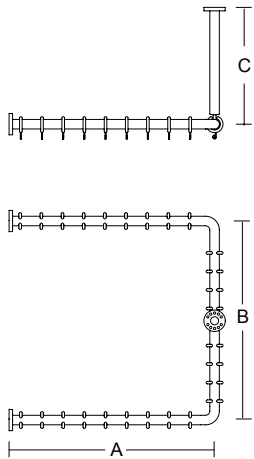

- Reggitenda su tre lati con supporto a soffitto
- Three-sided shower curtain rail with ceiling support
- Barre de rideau de douche sur trois côtés avec support plafond
- Barra de cortina de ducha en "U" con soporte de techo



ART.	A	B	C	⊙
4CN.437.00AB .xx	1000 (1040)*	1000 (1080)*	440 (480)*	30
4CN.437.00AC .xx	1200 (1240)*	1200 (1280)*	440 (480)*	36
4CN.437.00AD .xx	1500 (1540)*	1500 (1580)*	440 (480)*	45
4CN.437.99AB .xx	⊙	⊙	⊙	

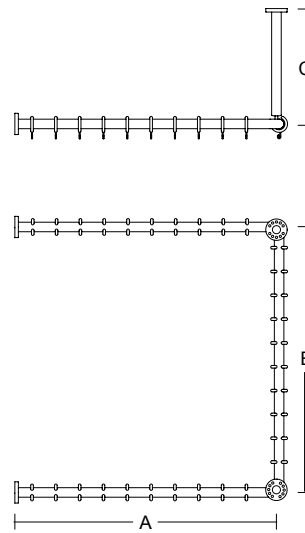

- Reggitenda su tre lati con due supporti a soffitto
- Three-sided shower curtain rail with two ceiling supports
- Barre de rideau de douche sur trois côtés avec deux supports plafond
- Barra de cortina de ducha en "U" con soportes de techo

THESE PRODUCTS CONTRIBUTE TO LEED® CREDITS

.XX FINISH	.A1	.01	.02	.03	.04	.05	.07	.09	.10	.17
LRV	87	76	65	27	9	5				





ART.	L	H	
4CN.0SC.000A.01	1200	750	Art. 4CN.435.0000 .xx . x 4CN.445.0RTV .xx 4CN.445.00RV .xx 4CN.445.0RLV .xx
4CN.0SC.000B.01	1200	2000	Art. 4CN.429.0000 .xx 4CN.429.000A .xx 4CN.429.000B .xx 4CN.429.000G .xx * 4CN.436.0000 .xx * 4CN.436.00PP .xx * 4CN.436.000B .xx * 4CN.436.00BA .xx * 4CN.436.00BB .xx *
4CN.0SC.000C.01	1800	2000	Art. 4CN.429.000C .xx 4CN.429.000D .xx 4CN.429.000E .xx 4CN.429.000F .xx 4CN.436.00BC .xx * 4CN.436.00BD .xx * 4CN.437.0000 .xx * 4CN.437.000A .xx * 4CN.437.00AB .xx * 4CN.437.00AC .xx ** 4CN.437.00AD .xx **
4CN.0SC.9999.01			

- Tenda ignifuga per doccia
- Fireproof shower curtain
- Rideau de douche ignifuge
- Cortina de ducha ignifuga

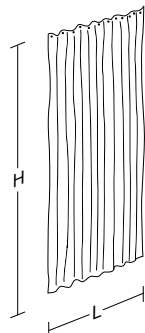

ART.	L	H	
4CN.0SC.00AE.01	1200	750	Art. 4CN.435.0000 .xx . x 4CN.445.0RTV .xx 4CN.445.00RV .xx 4CN.445.0RLV .xx
4CN.0SC.00BE.01	1200	2000	Art. 4CN.429.0000 .xx 4CN.429.000A .xx
4CN.0SC.00FE.01	1500	2000	Art. 4CN.429.000B .xx 4CN.429.000C .xx 4CN.436.00BC .xx * 4CN.437.0000 .xx *
4CN.0SC.00CE.01	1800	2000	Art. 4CN.429.000D .xx 4CN.429.000E .xx 4CN.429.000F .xx 4CN.436.00BD .xx * 4CN.437.000A .xx * 4CN.437.00AB .xx * 4CN.437.00AD .xx **
4CN.0SC.00DE.01	2000	2000	Art. 4CN.436.0000 .xx 4CN.436.00PP .xx 4CN.436.000B .xx 4CN.429.000G .xx
4CN.0SC.00EE.01	2400	2000	Art. 4CN.436.00BA .xx 4CN.436.00BB .xx 4CN.437.00AC .xx *
4CN.0SC.999E.01			

- Tenda poliestere per doccia
- Polyester shower curtain
- Rideau de douche en polyester
- Cortina de ducha de poliéster

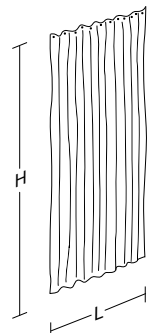

THESE PRODUCTS CONTRIBUTE TO LEED® CREDITS

* 2 PEZZI
** 3 PEZZI

* 2 PIECES
** 3 PIECES

* 2 PIÈCES
** 3 PIÈCES

* 2 PIEZAS
** 3 PIEZAS



◆ RIGHT

ART. ◆ A B
 4CN.435.0000 .xx . x 845* 440*

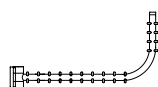
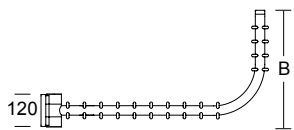
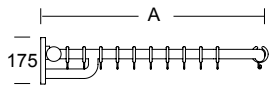

◆ .1 RIGHT

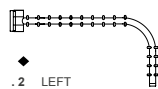

◆ .2 LEFT

- Reggitenda ribaltabile
- Lift-up shower curtain rail
- Barre de rideau de douche relevable
- Barra de cortina de ducha abatible

THESE PRODUCTS CONTRIBUTE TO LEED® CREDITS

.XX FINISH	.A1	.01	.02	.03	.04	.05	.07	.09	.10	.17
LRV										
		87	76	65		27	9	5		



ART. A
 4CN.436.0T01 .xx . x MIN 1022* - MAX 1783*

- Aluminum Anodized Silver
- Polyamid 6

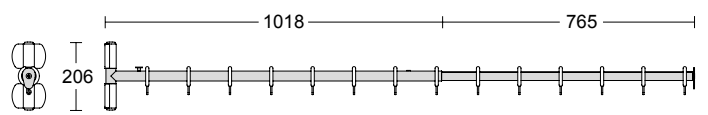
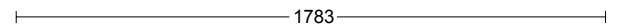
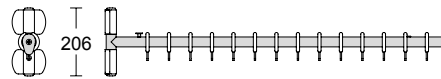
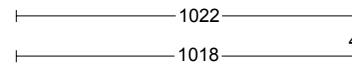
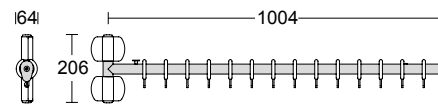

- Reggitenda telescopico estraibile ed orientabile
- Removable and adjustable telescopic shower curtain rail
- Barre de rideau de douche extensible amovible et réglable
- Barra de cortina de ducha telescópica extraíble y orientable

- ◆ .1 DESTRO RIGHT DROITE DERECHA
- ◆ .2 SINISTRO LEFT GAUCHE IZQUIERDA



ART.	A	B	C	α
4CN.470.000D .xx	615	515	160	14°
4CN.470.000QD .xx	615	665	200	14°



ART.	A	B	C	α
4CN.470.0000 .xx	615*	515*	160*	14°
4CN.470.000Q .xx	615*	665*	200*	14°

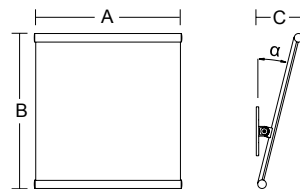
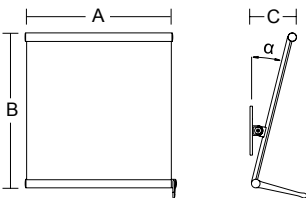

- Specchio orientabile con asta di movimento
- Adjustable mirror with control rod
- Miroir orientable avec bras de commande
- Espejo orientable con varilla movable



- Specchio orientabile con cornice
- Adjustable mirror with frame
- Miroir orientable avec cadre
- Espejo orientable con marco

THESE PRODUCTS CONTRIBUTE TO LEED® CREDITS

.XX FINISH	.A1	.01	.02	.03	.04	.05	.07	.09	.10	.17
LRV										
		87	76	65		27	9	5		



ART.	A	B	C
4CN.490.000R .xx	600*	500	550*
4CN.490.00QR .xx	600*	650	700*
4CN.490.00AR .xx	600*	950	1000*

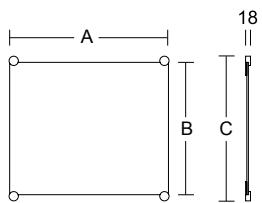

- Specchio fisso
- Fixed mirror
- Miroir fixe
- Espejo fijo

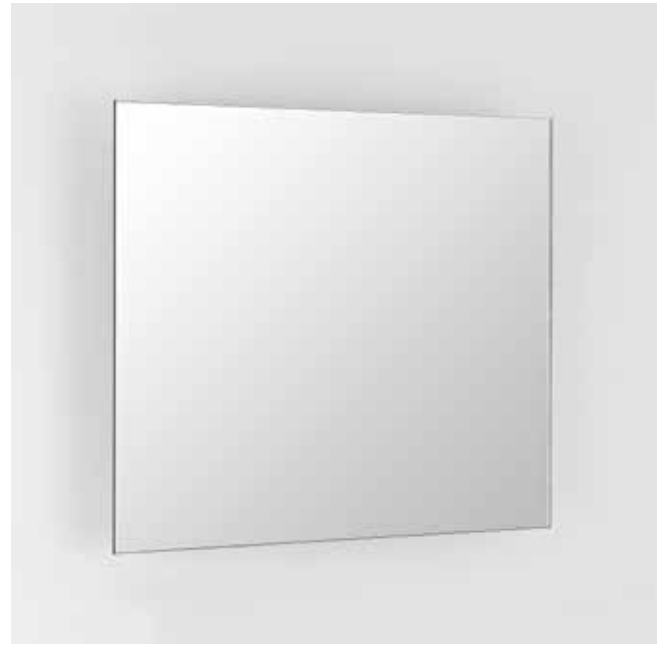

ART.	A	B	C	α
4CA.471.0000.00	600*	500*	160*	18°
4CA.471.000Q.00	600*	650*	210*	18°

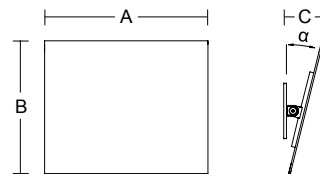

- Specchio orientabile senza cornice
- Adjustable mirror without frame
- Miroir orientable sans cadre
- Espejo orientable sin marco

THESE PRODUCTS CONTRIBUTE TO LEED® CREDITS

.XX FINISH	.A1	.01	.02	.03	.04	.05	.07	.09	.10	.17
LRV										
		87	76	65		27	9	5		



ART. A
4CN.411.00SA .xx 235*

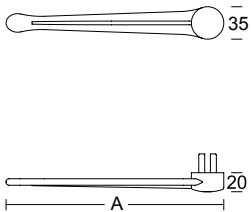

- Asta di movimento per specchio orientabile
- Control rod for adjustable mirror
- Bras de commande pour miroir orientable
- Varilla para movimiento de espejo orientable



ART. A B
4CN.490.0WHR .xx 38 64



- Kit pinza reggispecchio per specchio fisso (4 pezzi)
- Kit mirror-holder supports for fixed mirror (4 pieces)
- Jeu supports porte-miroir pour miroir fixe (4 pièces)
- Juego pinza para anclar el espejo fijo (4 piezas)

THESE PRODUCTS CONTRIBUTE TO LEED® CREDITS

.XX FINISH	.A1	.01	.02	.03	.04	.05	.07	.09	.10	.17
LRV										
		87	76	65		27	9	5		



ART.	A	B
4CN.407.0TUC .xx	405*	75*



ART.	A	B
4CN.407.0TUR .xx	405*	77*

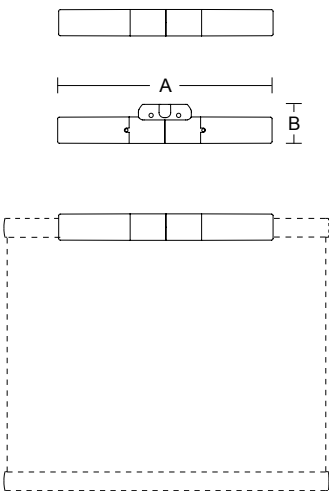

- Lampada da applicare su specchi con cornice.
IP 54 con Art. 4CN.0IP.0068.00
- Lamp for mirrors with frame.
IP 54 with Art. 4CN.0IP.0068.00
- Lampe pour miroirs avec cadre.
IP 54 avec Art. 4CN.0IP.0068.00
- Aplique para espejos con marco
IP 54 con Art. 4CN.0IP.0068.00

CE
IP 54

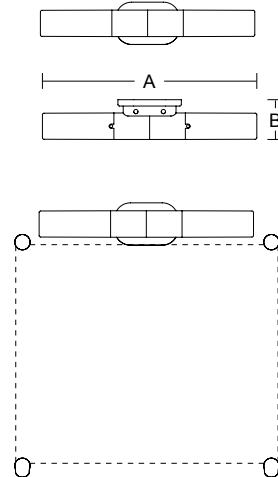

- Lampada da fissare a parete.
IP 54 con Art. 4CN.0IP.0068.00
- Wall lamp for mirror.
IP 54 with Art. 4CN.0IP.0068.00
- Lampe de mur pour miroir.
IP 54 avec Art. 4CN.0IP.0068.00
- Aplique con fijación en pared
IP 54 con Art. 4CN.0IP.0068.00

CE
IP 54

THESE PRODUCTS CONTRIBUTE TO LEED® CREDITS

.XX FINISH	.A1	.01	.02	.03	.04	.05	.07	.09	.10	.17
LRV										
		87	76	65		27	9	5		



ART.	A	B
4CN.407.00TU .xx	405*	84*



ART.	A	B	C
4CN.492.0000 .xx	250*	130*	35*

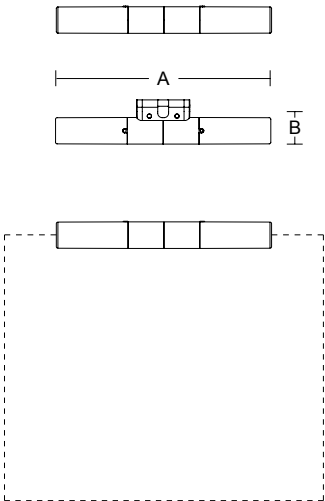

- Lampada da applicare su specchi senza cornice.
IP 54 con Art. 4CN.0IP.0068.00
- Lamp for mirrors without frame.
IP 54 with Art. 4CN.0IP.0068.00
- Lampe pour miroirs sans cadre.
IP 54 avec Art. 4CN.0IP.0068.00
- Aplique para espejos sin marco
IP 54 con Art. 4CN.0IP.0068.00

CE
IP 54

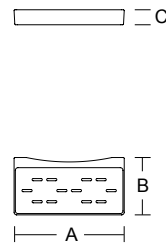

- Mensola portaoggetti
- Bathroom shelf
- Tablette porte-objet
- Estante porta-objetos

THESE PRODUCTS CONTRIBUTE TO LEED® CREDITS

.XX FINISH	.A1	.01	.02	.03	.04	.05	.07	.09	.10	.17
LRV										
		87	76	65	65	27	27	9	5	



ART.	A	B	C
4CN.492.000B .xx	210*	120*	110*

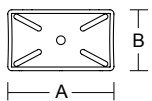
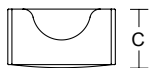

- Mensola applicabile su supporto orizzontale
- Shelf to be integrated to horizontal support
- Tablette accrochable à la barre d'appui horizontale
- Estante aplicable a asidero horizontal



ART.	A	B	C
4CN.493.0000 .xx	190*	190*	35* glass
4CN.493.000P .xx	190*	190*	35* plexiglas

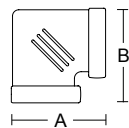
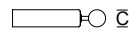

- Mensola ad angolo
- Corner shelf
- Tablette à coin
- Estante en ángulo

THESE PRODUCTS CONTRIBUTE TO LEED® CREDITS

.XX FINISH	.A1	.01	.02	.03	.04	.05	.07	.09	.10	.17
LRV										
		87	76	65		27		9	5	



ART.	A	B
4CN.484.000V .xx	620 (655)*	140* glass
4CN.484.000P .xx	620 (655)*	140* plexiglas

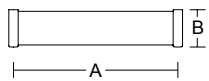

- Mensola
- Shelf
- Tablette
- Estante



ART.	A	B
4CN.484.00VB .xx	600 (635)*	140* glass

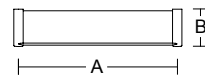

- Mensola con bordo in nylon
- Shelf with nylon edge
- Tablette avec bord en nylon
- Estante con borde de nylon

THESE PRODUCTS CONTRIBUTE TO LEED® CREDITS

.XX FINISH	.A1	.01	.02	.03	.04	.05	.07	.09	.10	.17
LRV										
		87	76	65		27	9	5		



ART.	A	B
4CN.484.00AL .xx	600 (635)*	142* aluminium
4CN.484.99AL .xx		142* aluminium

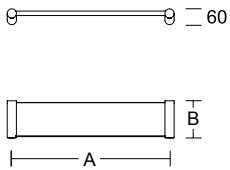

ART.	A	B
4CN.484.0BAL .xx	650 (685)*	150* aluminium

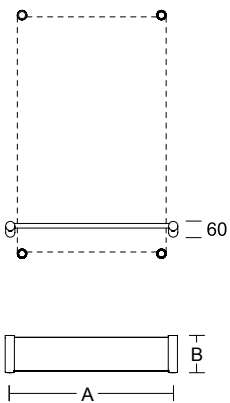

- Mensola con bordo in alluminio ossidato argento
- Bathroom shelf with silver oxidised aluminium edge
- Tablette avec bord en aluminium oxydé argent
- Estante con borde de aluminio oxidado plata



ART.	A	B
4CN.485.0IAL .xx	600 (635)*	142* aluminium
4CN.485.9IAL .xx		142* aluminium

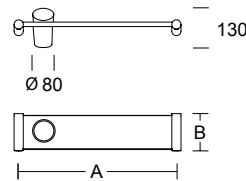

ART.	A	B
4CN.485.IBAL .xx	650 (685)*	150* aluminium

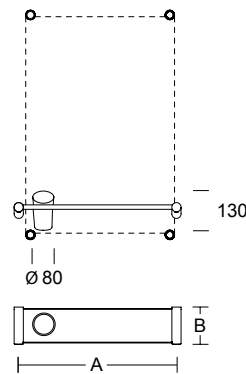

- Mensola con bordo in alluminio ossidato argento, con bicchiere conico
- Bathroom shelf with silver oxidised aluminium edge and conical tumbler
- Tablette avec bord en aluminium oxydé argent et gobelet conique
- Estante con borde de aluminio oxidado plata, con vaso cónico

THESE PRODUCTS CONTRIBUTE TO LEED® CREDITS

.XX FINISH	.A1	.01	.02	.03	.04	.05	.07	.09	.10	.17
LRV										
		87	76	65		27	9	5		



ART.	A	B	C
CAP.498.0000.30	120	265*	320*

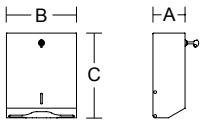

- Portasalvietta verniciato bianco
 - White varnished paper towel dispenser
 - Distributeur d'essuie-mains papier en coloris laqué blanc
 - Dispensador de papel toallas pintado blanco
- Colore
 Colour
 Couleur
 Color

THESE PRODUCTS CONTRIBUTE TO LEED® CREDITS



ART.	A	B
4CN.457.0000.xx	145	105

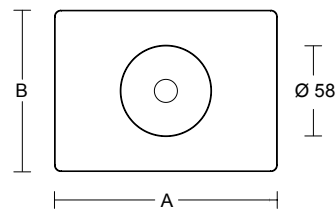

- Dispenser sacchetti igienici da parete o da appoggio
- Hygienic bag dispenser to be installed on the wall or on a stand
- Distributeur de sacs hygiéniques pour montage murale ou pose sur une surface
- Dispensador de bolsas higiénicas para montar en pared o para apoyar

.XX FINISH	.A1	.01	.02	.03	.04	.05	.07	.09	.10	.17
LRV										
		87	76	65	27	9	5			



ART.	A	B	C
4CN.456.0000 .xx	105*	113*	190*

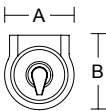
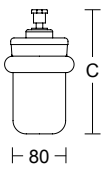

- Dispenser sapone da parete (lt 0,4)
- Wall soap dispenser (lt 0,4)
- Distributeur de savon mural (lt 0,4)
- Dispensador de jabón de pared (lt 0,4)



ART.	A	B
4CN.483.0IBN .xx	105*	113*

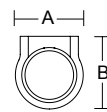
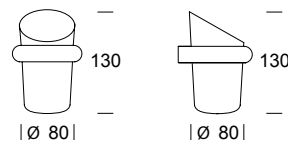

- Portabicchiere con bicchiere conico
- Tumbler holder with conical tumbler
- Porte gobelet avec gobelet conique
- Portavaso con vaso cónico

THESE PRODUCTS CONTRIBUTE TO LEED® CREDITS

.XX FINISH	.A1	.01	.02	.03	.04	.05	.07	.09	.10	.17
LRV										
		87	76	65		27	9	5		



Design Brad Ascalon

ART.	A	B	C
4CN.483.0BBA .xx	120*	120*	130*

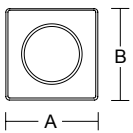
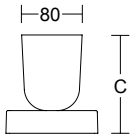

- Portabicchiere
- Tumbler holder
- Porte gobelet
- Portavaso

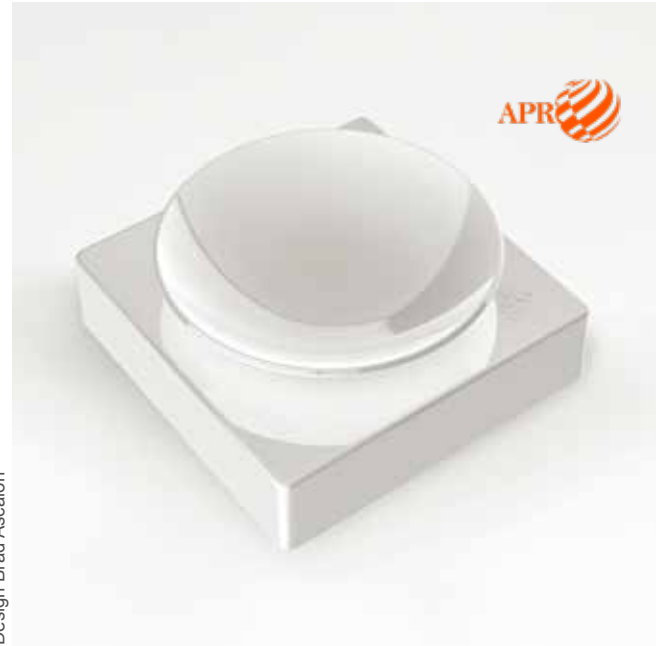

Design Brad Ascalon

ART.	A	B	C
4CN.483.00BA .xx	120*	120*	45*

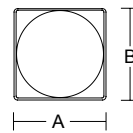
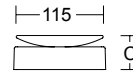

- Portasapone
- Soap dish
- Porte savon
- Jabonera

THESE PRODUCTS CONTRIBUTE TO LEED® CREDITS

.XX FINISH	.A1	.01	.07
LRV			
	87	27	



ART.	A	B	C
4CN.483.000N .xx	110*	115*	40*

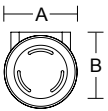

- Portasapone
- Soap dish
- Porte savon
- Jabonera



ART.	A	B	C	α
4CN.497.000P. xx	200*	187*	338*	5°

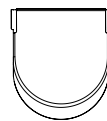
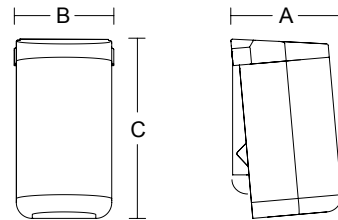

- Cestino a parete con apertura a spinta (lt. 7,5)
- Wall waste bin with push opening (lt. 7,5)
- Poubelle murale ouverture par pression (lt. 7,5)
- Cubo de basura para montar en la pared con apertura mediante presión (lt. 7,5)

THESE PRODUCTS CONTRIBUTE TO LEED® CREDITS

.XX FINISH	.A1	.01	.02	.03	.04	.05	.07	.09	.10	.17
LRV										
		87	76	65		27	9	5		

.XX FINISH	.A1	.01
LRV		
		87



ART.	A	B
4CN.481.0000 .xx	160*	120*

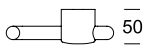
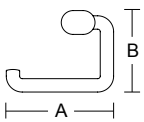

- Portarotolo a muro
- Wall toilet roll holder
- Porte-papier murale
- Portarrollo de pared

THESE PRODUCTS CONTRIBUTE TO LEED® CREDITS

.XX FINISH	.A1	.01	.02	.03	.04	.05	.07	.09	.10	.17
LRV										
		87	76	65		27	9	5		



Design Brad Ascalon

ART.	A	B
4CN.481.00BA .xx	157*	126*

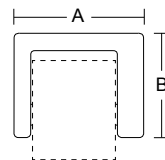
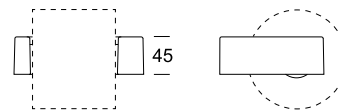

- Portarotolo a muro
- Wall toilet paper
- Porte-papier murale
- Portarrollo de pared

.XX FINISH	.A1	.01	.07
LRV			
		87	27



ART.	A	B
4CN.481.0RLN .xx	76*	290*

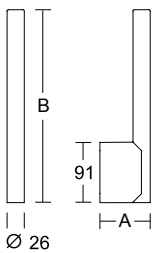

- Portarotolo di riserva
- Spare toilet roll holder
- Porte-papier de réserve
- Portarrollo de reserva

THESE PRODUCTS CONTRIBUTE TO LEED® CREDITS

.XX FINISH	.A1	.01	.02	.03	.04	.05	.07	.09	.10	.17
LRV										
		87	76	65	27	9	5			



Design Brad Ascalon

ART.	A	B	C
4CN.481.0RBA .xx	120*	120*	234*

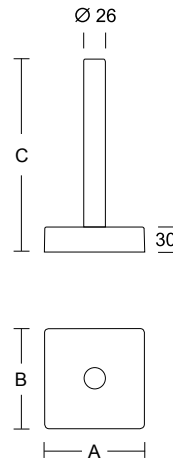

- Portarotolo di riserva
- Spare toilet roll holder
- Porte-papier de réserve
- Portarrollo de reserva

.XX FINISH	.A1	.01	.07
LRV			
		87	27



ART. A B
 4CN.481.000R .xx 130° Ø 68



ART.
 4CN.482.000U .xx

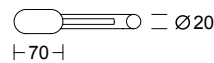
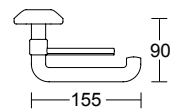
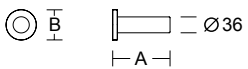

- Portarotolo di riserva
- Spare toilet roll holder
- Porte-papier de réserve
- Portarrollo de reserva

- Portarotolo a montaggio rapido su sostegni
- Quick assembly toilet roll holder for safety supports
- Porte-papier à assemblage rapide pour barre d'appui
- Portarrollo para montaje rápido en asidero

THESE PRODUCTS CONTRIBUTE TO LEED® CREDITS

.XX FINISH	.A1	.01	.02	.03	.04	.05	.07	.09	.10	.17
LRV										
		87	76	65		27	9	5		



ART.
4CN.482.00RU .xx

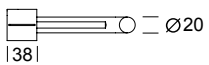
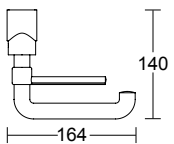

- Portarotolo con supporto in acciaio inox 316L per rapida applicazione in cantiere senza foratura dell'ausilio
- Toilet roll holder with stainless steel AISI 316L hook for quick mounting on site without drill holes
- Porte-papier avec crochet en acier inox AISI 316L pour assemblage rapide sur place sans percer la barre
- Portarollo con soporte de acero inoxidable AISI 316L para montaje rápido en obra sin taladrar el asidero

THESE PRODUCTS CONTRIBUTE TO LEED® CREDITS

.XX FINISH	.A1	.01	.02	.03	.04	.05	.07	.09	.10	.17
LRV										
		87	76	65		27	9	5		



ART.	A	B	C
4CN.486.0000 .xx	105*	115*	380*

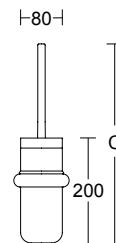

- Portascopino
- Toilet brush set
- Ensemble brosse WC
- Escobillero



ART.	A	B	C
4CN.486.000C .xx	115*	118*	420*
4CN.486.00CL .xx	115*	118*	520*

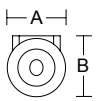
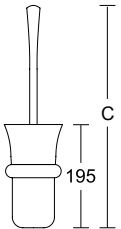

- Portascopino ad imbocco conico ed impugnatura ergonomica
- Conical toilet brush set with ergonomic handle
- Ensemble brosse WC conique avec manche ergonomique
- Escobillero cónico con mango ergonómico

THESE PRODUCTS CONTRIBUTE TO LEED® CREDITS

.XX FINISH	.A1	.01	.02	.03	.04	.05	.07	.09	.10	.17
LRV										
		87	76	65		27	9	5		



Design Brad Ascalon

ART.	A	B	C
4CN.486.00BA .xx	120*	120*	438*

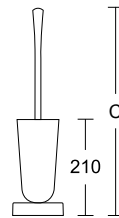

- Portascopino
- Toilet brush set
- Ensemble brosse WC
- Escobillero

.XX FINISH	.A1	.01	.07
LRV			
		87	27



ART. A
4CN.486.000D .xx 555

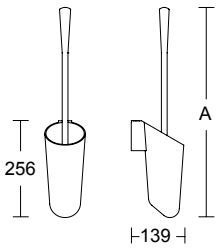

- Portascopino con attacco a muro integrato
- Conical toilet brush set with integrated wall fixing
- Ensemble brosse WC conique avec fixation murale intégrée
- Escobillero cónico con fijación en pared integrada



ART. A B
4CN.426.000A .xx 302* 184*

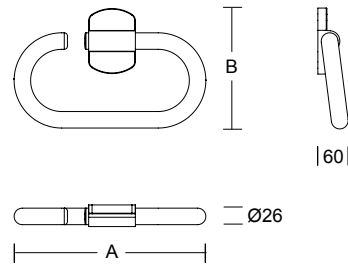

- Portasciugamani
- Towel holder
- Porte-serviette
- Toallero

THESE PRODUCTS CONTRIBUTE TO LEED® CREDITS

.XX FINISH	.A1	.01	.02	.03	.04	.05	.07	.09	.10	.17
LRV										
		87	76	65		27		9	5	



ART.	A	B
4CN.489.000N .xx	364 (400)*	100*
4CN.489.00AN .xx	464 (500)*	100*
4CN.489.00BN .xx	564 (600)*	100*
4CN.489.00CN .xx	764 (800)*	100*
4CN.489.999N .xx	 100*	100*

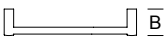
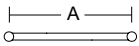

- Portasciugamani
- Towel holder
- Porte-serviette
- Toallero





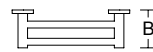
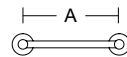







ART.	A	B
4CN.489.000D .xx	364 (445)*	145*
4CN.489.00AD .xx	464 (545)*	145*
4CN.489.00BD .xx	564 (645)*	145*
4CN.489.00CD .xx	764 (845)*	145*
4CN.489.999D .xx	 145*	145*



- Portasciugamani
- Towel holder
- Porte-serviette
- Toallero

THESE PRODUCTS CONTRIBUTE TO LEED® CREDITS

.XX FINISH	.A1	.01	.02	.03	.04	.05	.07	.09	.10	.17
LRV										
		87	76	65		27	9	5		



ART.	A	B
4CN.319.0000 . xx	250 (318)*	80*
4CN.320.0000 . xx	300 (368)*	80*

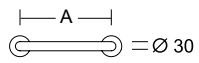

- Portasciugamani
- Towel holder
- Porte-serviette
- Toallero





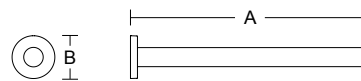







ART.	A	B
4CN.425.0000 . xx	450*	Ø 80
4CN.425.9999 . xx		Ø 80



- Portasciugamani
- Towel holder
- Porte-serviette
- Toallero

THESE PRODUCTS CONTRIBUTE TO LEED® CREDITS

.XX FINISH	.A1	.01	.02	.03	.04	.05	.07	.09	.10	.17
LRV										
		87	76	65		27		9	5	



ART.	A	B
4CN.426.000M .xx	500*	115*

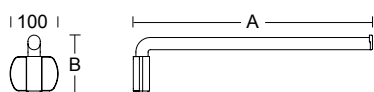

- Portasciugamani girevole singolo
- Single movable towel-holder
- Porte-serviette orientable simple
- Toallero individual móvil



ART.	A	B
4CN.426.00DM .xx	500*	155*

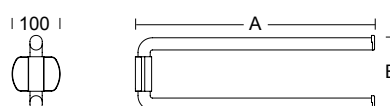

- Portasciugamani girevole doppio
- Double movable towel-holder
- Porte-serviette orientable double
- Toallero doble móvil

THESE PRODUCTS CONTRIBUTE TO LEED® CREDITS

.XX FINISH	.A1	.01	.02	.03	.04	.05	.07	.09	.10	.17
LRV										
		87	76	65		27	9	5		



ART.	A	B
4CN.488.0000 .xx	Ø 52	65*



ART.	A	B
4CN.488.000P .xx	Ø 52	47*

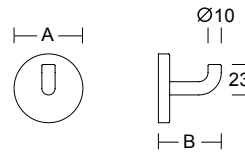
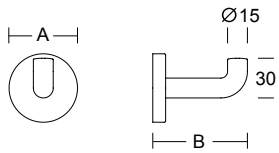

- Gancio appendiabiti
- Cloth hook
- Patère
- Percha

- Gancio appendiabiti piccolo
- Small cloth hook
- Patère petite
- Percha pequeña

THESE PRODUCTS CONTRIBUTE TO LEED® CREDITS

.XX FINISH	.A1	.01	.02	.03	.04	.05	.07	.09	.10	.17
LRV										
		87	76	65		27	9	5		



ART.	A	B
4CN.488.000D .xx	Ø 55	40*

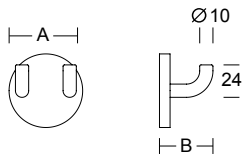

- Gancio appendiabiti doppio
- Double cloth hook
- Patère double
- Percha doble



ART.	A	B
5CN.562.0000 .xx	Ø 53	75*

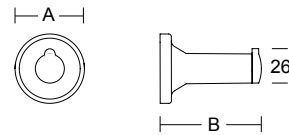

- Appendiabiti fermaporta
- Door-stop cloth hook
- Patère-butoir
- Tope-percha

THESE PRODUCTS CONTRIBUTE TO LEED® CREDITS

.XX FINISH	.A1	.01	.02	.03	.04	.05	.07	.09	.10	.17
LRV										
		87	76	65		27	9	5		



ART.	A	B
4CN.494.0000 .xx	150*	60*



ART.	A	B
4CN.495.0000 .xx	150*	60*

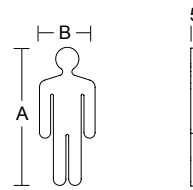
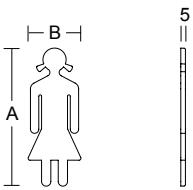

- Pittogramma donna
- Lady pictogram
- Pictogramme femme
- Pictograma mujer

- Pittogramma uomo
- Man pictogram
- Pictogramme homme
- Pictograma hombre

THESE PRODUCTS CONTRIBUTE TO LEED® CREDITS

.XX FINISH	.A1	.01	.02	.03	.04	.05	.07	.09	.10	.17
LRV										
		87	76	65		27		9	5	





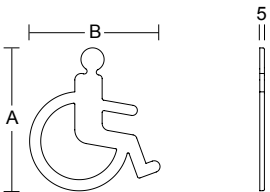







ART.	A	B
4CN.496.0000 .xx	155*	145*



- Pittogramma disabile
- Disabled pictogram
- Pictogramme handicapé
- Pictograma minusválido

THESE PRODUCTS CONTRIBUTE TO LEED® CREDITS

.XX FINISH	.A1	.01	.02	.03	.04	.05	.07	.09	.10	.17
LRV										
		87	76	65		27	9	5		

.XX FINISH	.A1	.01	.02	.03	.04	.05	.07	.09	.10	.17
LRV										
		87	76		65		27	9	5	





◆ RIGHT

ART.	◆	A	B
4CN.422.00AP .xx .x		220 (300)*	520 (600)*
4CN.22J.00AP .xx .x			
4CN.22Y.00AP .xx .x			
4CN.422.00APM .xx .x		300 (380)*	520 (600)*
4CN.22J.00APM .xx .x			
4CN.22Y.00APM .xx .x			
4CN.422.00AP0 .xx .x		500 (580)*	750 (830)*
4CN.22J.00AP0 .xx .x			
4CN.22Y.00AP0 .xx .x			

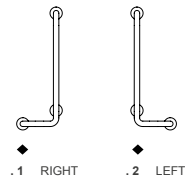
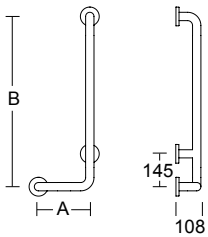

- Sostegno di sicurezza a "L" "Adipose"
- "Adipose" "L"-shaped safety support
- Barre d'appui forme à "L" "Adipose"
- Asidero en "L" serie "Adipose"



ART.	A
4CN.487.00AP .xx	570 (650)*
4CN.487.00APA .xx	770 (850)*
4CN.487.00APB .xx	970 (1050)*

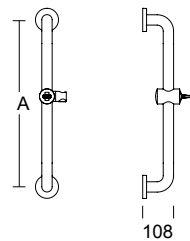

- Sostegno di sicurezza con reggisoffione "Adipose"
- Vertical safety support with shower head holder "Adipose"
- Barre d'appui verticale "Adipose" avec curseur de douche
- Asidero con soporte para ducha regulable serie "Adipose"



THESE PRODUCTS CONTRIBUTE TO LEED® CREDITS

.XX FINISH	.A1	.01	.02	.03	.04	.05	.07	.09	.10	.17
LRV										
		87	76	65		27	9	5		

- ◆
- .1 DESTRO RIGHT DROITE DERECHA
- .2 SINISTRO LEFT GAUCHE IZQUIERDA



ART.	A
4CN.440.00AP .xx	370 (450)*
4CN.40Y.00AP .xx	
4CN.440.0APZ .xx	300 (380)*
4CN.40Y.0APZ .xx	
4CN.440.0APX .xx	530 (610)*
4CN.40Y.0APX .xx	

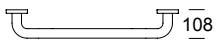
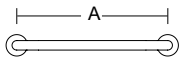

- Sostegno di sicurezza orizzontale "Adipose"
- Horizontal safety support "Adipose"
- Barre d'appui horizontale "Adipose"
- Asidero horizontal serie "Adipose"



ART.	A
4CN.442.00AP .xx	760 (800)*

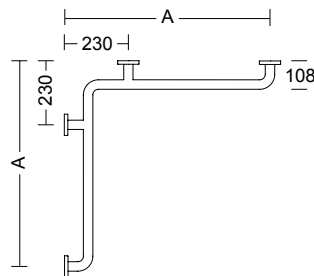
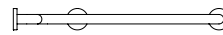

- Sostegno di sicurezza ad angolo simmetrico "Adipose"
- Symmetric corner safety support "Adipose"
- Barre d'appui à coin symétrique "Adipose"
- Asidero en ángulo simétrico serie "Adipose"



THESE PRODUCTS CONTRIBUTE TO LEED® CREDITS

.XX FINISH	.A1	.01	.02	.03	.04	.05	.07	.09	.10	.17
LRV										
		87	76	65		27	9	5		



◆ LINKS

ART.	◆	A	B
4CN.845.00RT .xx .x		600*	☺
4CN.845.000R .xx .x		700*	☺
4CN.845.00RL .xx .x		850*	☺

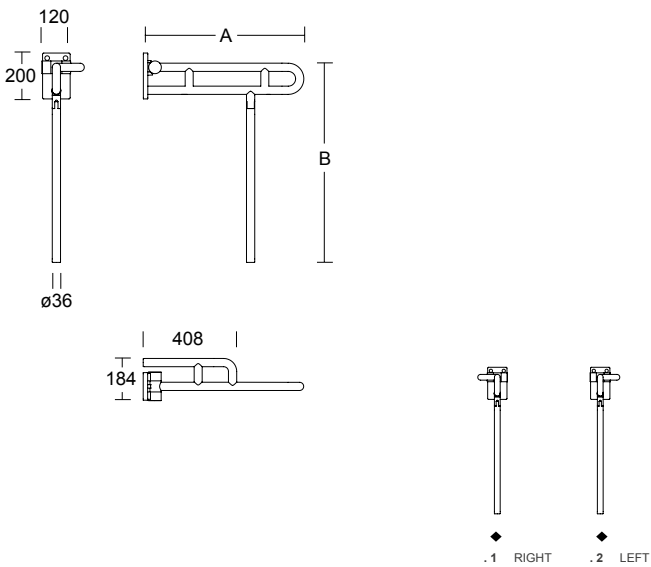

- Sostegno di sicurezza ribaltabile con frizione regolabile, sostegno snodato a pavimento e sostegno laterale "Adipose"
- Lift-up safety support with friction device, articulated floor support and lateral support "Adipose"
- Barre d'appui relevable avec dispositif de friction, support au sol articulé et support latéral "Adipose"
- Asidero abatible con embrague regulable, soporte articulado en el suelo y apoyo lateral serie "Adipose"



THESE PRODUCTS CONTRIBUTE TO LEED® CREDITS

.XX FINISH	.A1	.01	.02	.03	.04	.05	.07	.09	.10	.17
LRV	□	87	76	65	27	9	5			

- ◆ .1 DESTRO RIGHT DROITE DERECHA
- .2 SINISTRO LEFT GAUCHE IZQUIERDA



ART.	A	B	C
4CN.855.0000 .xx	383*	597*	620*

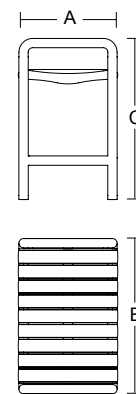

- Sgabello con struttura rinforzata "Adipose"
- Stool with reinforced structure "Adipose"
- Tabouret avec structure renforcée "Adipose"
- Taburete con estructura reforzada serie "Adipose"







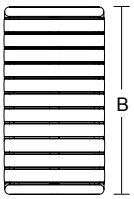
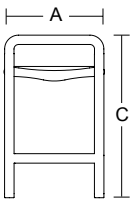







ART.	A	B	C
 4CN.855.000L .xx	383*	825*	620*













- Sgabello con struttura rinforzata "Adipose"
- Stool with reinforced structure "Adipose"
- Tabouret avec structure renforcée "Adipose"
- Taburete con estructura reforzada serie "Adipose"



THESE PRODUCTS CONTRIBUTE TO LEED® CREDITS

.XX FINISH	.A1	.01	.02	.03	.04	.05	.07	.09	.10	.17
LRV										
		87	76	65		27	9	5		

.XX FINISH	.A1	.01	.02	.03	.04	.05	.07	.09	.10	.17
LRV										
		87	76		65		27	9	5	



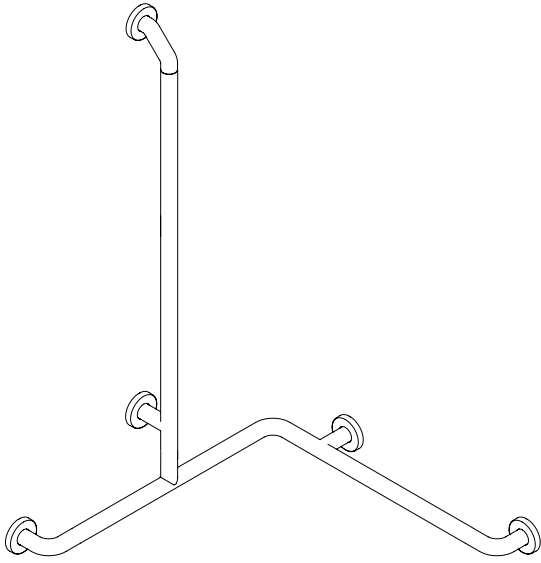

◆ LEFT

ART.	◆	A	B	C
4CN.443.0ASB . xx . x		760 (800)*	760 (800)*	1160 (1240)*
4CN.43J.0ASB . xx . x				
4CN.443.ASBL . xx . x		760 (800)*	1185 (1225)*	1160 (1240)*
4CN.43J.ASBL . xx . x				
4CN.443.9ASB . xx . x				
4CN.43J.9ASB . xx . x				

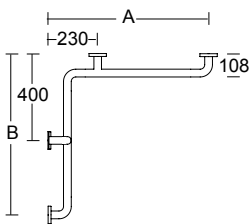
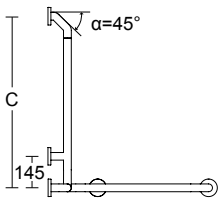

◆ .1 RIGHT

◆ .2 LEFT

- Sostegno di sicurezza ad angolo con curva inclinata e impugnatura verticale
- Corner safety support with inclined bend and shower head rail
- Barre d'appui à coin avec coude inclinée et barre de douche
- Asidero en ángulo con codo inclinado con empuñadura vertical

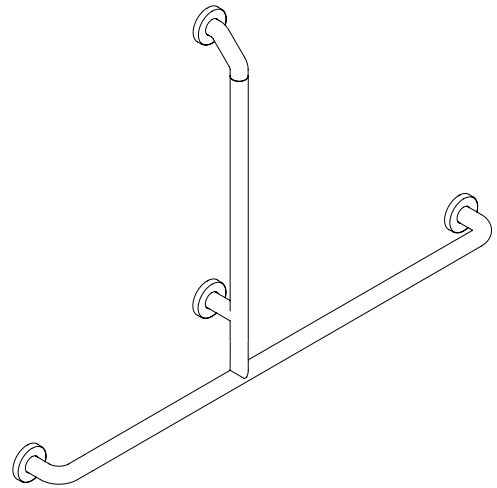

ART.	A	B
4CN.433.00AS . xx	1570 (1650)*	820 (900)*
4CN.33J.00AS . xx		
4CN.33Y.00AS . xx		
4CN.433.99AS . xx		
4CN.33J.99AS . xx		
4CN.33Y.99AS . xx		

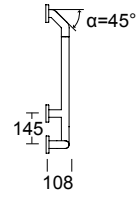
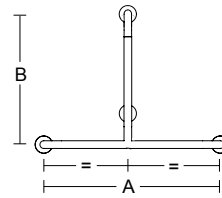

- Sostegno di sicurezza a "T" con curva inclinata
- "T"-shaped safety support with inclined bend
- Barre d'appui forme à "T" avec coude inclinée
- Asidero en "T" con codo inclinado



THESE PRODUCTS CONTRIBUTE TO LEED® CREDITS

.XX FINISH	.A1	.01	.02	.03	.04	.05	.07	.09	.10	.17
LRV										
		87	76	65	27	9	5			

- ◆ .1 DESTRO RIGHT DROITE DERECHA
- ◆ .2 SINISTRO LEFT GAUCHE IZQUIERDA

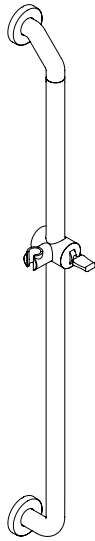

ART.	A
4CN.487.0ASC .xx	1170 (1250)*
4CN.487.99AS .xx	

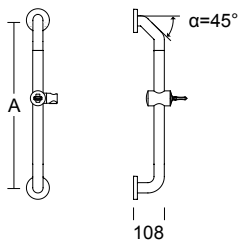

- Sostegno di sicurezza con reggisoffione con curva inclinata
- Fixed safety support with inclined bend and shower head holder
- Barre d'appui fixe avec curseur de douchette avec coude inclinée
- Asidero con soporte para ducha regulable en altura con codo inclinado



THESE PRODUCTS CONTRIBUTE TO LEED® CREDITS

.XX FINISH	.A1	.01	.02	.03	.04	.05	.07	.09	.10	.17
LRV										
		87	76	65		27	9	5		

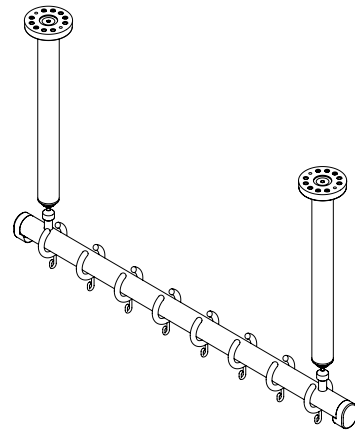

ART.	A	
4CN.429.00AS .xx	800*	8
4CN.429.0ASA .xx	900*	9
4CN.429.0ASB .xx	1000*	10
4CN.429.0ASC .xx	1100*	11
4CN.429.0ASD .xx	1200*	12
4CN.429.0ASE .xx	1300*	13
4CN.429.0ASF .xx	1500*	15
4CN.429.0ASG .xx	1700*	17
4CN.429.99AS .xx		

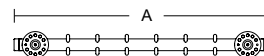
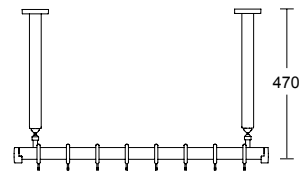

- Reggitenda dritto con 2 supporti a soffitto con dispositivo di sgancio meccanico anti-suicidio
- Straight shower curtain rail with 2 ceiling supports with anti-suicide release system
- Barre de rideau de douche droit avec 2 supports plafond avec système de décrochage mécanique anti-suicide
- Barra de cortina de ducha recta con 2 soportes de techo con dispositivo de desenganche mecánico anti-suicidio

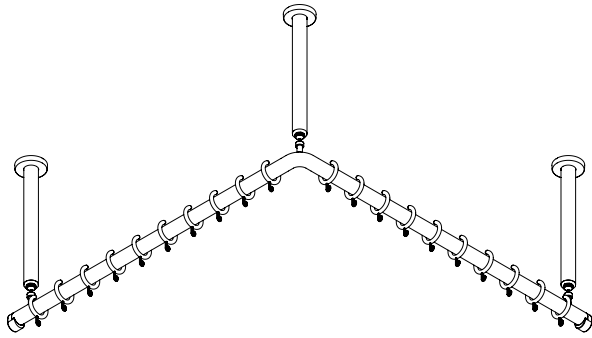

ART.	A	B	C	🔗
4CN.436.0ASB .xx	800 (840)*	800 (840)*	440 (470)*	16
4CN.436.ASBA .xx	900 (940)*	900 (940)*	440 (470)*	18
4CN.436.ASBB .xx	1000 (1040)*	1000 (1040)*	440 (470)*	20
4CN.436.ASBC .xx	1200 (1240)*	1200 (1240)*	440 (470)*	24
4CN.436.ASBD .xx	1500 (1540)*	1500 (1540)*	440 (470)*	30
4CN.436.9ASB .xx	🔗	🔗	🔗	

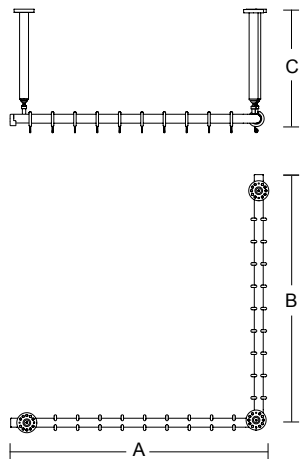

- Reggitenda angolare con 3 supporti a soffitto con dispositivo di sgancio meccanico anti-suicidio
- Corner shower curtain rail with 3 ceiling supports with anti-suicide release system
- Barre de rideau de douche à coin avec 3 supports plafond avec système de décrochage mécanique anti-suicide
- Barra de cortina de ducha en ángulo con tres soportes de techo con dispositivo de desenganche mecánico anti-suicidio

THESE PRODUCTS CONTRIBUTE TO LEED® CREDITS

.XX FINISH	.A1	.01	.02	.03	.04	.05	.07	.09	.10	.17
LRV	87	76	65	27	9	5				

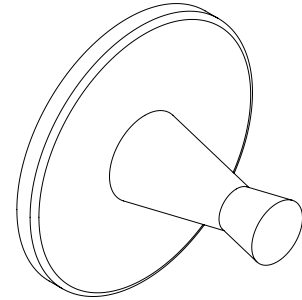

ART.	A	B
4CN.488.0ASP .xx	Ø 50	34*

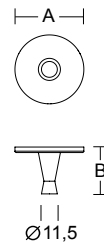

- Gancio appendiabiti
- Cloth hook
- Patère
- Percha

.XX FINISH	.A1	.01	.07
LRV	87	27	

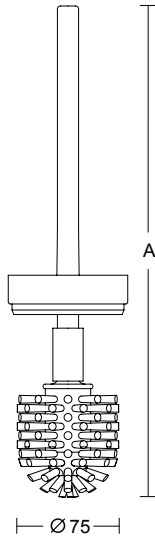

ART.	A
4CN.486.000R .xx	330*

- Scopino di riserva con impugnatura per art. 4CN.486.0000
- Spare toilet brush with handle for art. 4CN.486.0000
- Brosse WC de réserve avec manche pour art. 4CN.486.0000
- Escobilla de reserva con mango para art. 4CN.486.0000



ART.	A
4CN.486.00CR .xx	380*
4CN.486.0CRL .xx	480*

- Scopino di riserva con impugnatura per art. 4CN.486.000C/CL
- Spare toilet brush with handle for art. 4CN.486.000C/CL
- Brosse WC de réserve avec manche pour art. 4CN.486.000C/CL
- Escobilla de reserva con mango para art. 4CN.486.000C/CL

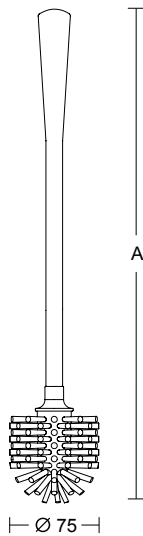

ART.	A
4CN.486.00DR.00	536*

- Scopino di riserva con asta per portascopino conico con attacco a muro integrato per art. 4CN.486.000D
- Spare toilet brush with handle for conical toilet brush set with integrated wall fixing for art. 4CN.486.000D
- Brosse WC avec manche pour ensemble brosse WC conique avec fixation murale intégrée pour art. 4CN.486.000D
- Escobilla de reserva con mango para escobillero cónico con fijación en pared integrada para art. 4CN.486.000D

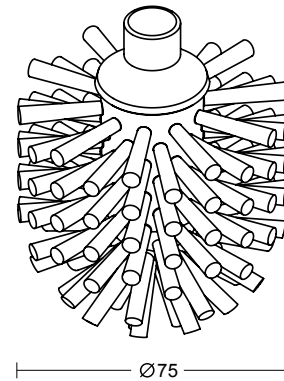

ART.
4CN.486.00BD.00

- Spazzola di riserva per asta portascopino conico con attacco a muro integrato per art. 4CN.486.000D
- Spare toilet brush head for conical toilet brush set with integrated wall fixing for art. 4CN.486.000D
- Tête brosse WC de réserve pour ensemble brosse WC conique avec fixation murale intégrée pour art. 4CN.486.000D
- Cabezal de escobilla de reserva para escobillero cónico con fijación en pared integrada para art. 4CN.486.000D

THESE PRODUCTS CONTRIBUTE TO LEED® CREDITS

.XX FINISH	.A1	.01	.02	.03	.04	.05	.07	.09	.10	.17
LRV										
		87	76	65	27	9	5			

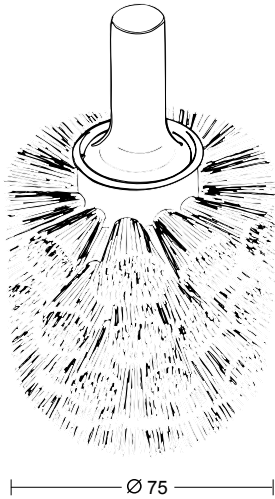

ART.
4CN.486.000B.00

- Scopino di riserva per art. 4CN.486.000C/CL
- Spare toilet brush head for art. 4CN.486.000C/CL
- Tête brosse WC de réserve pour art. 4CN.486.000C/CL
- Cabezal de escobilla de reserva para escobillero para art. 4CN.486.000C/CL

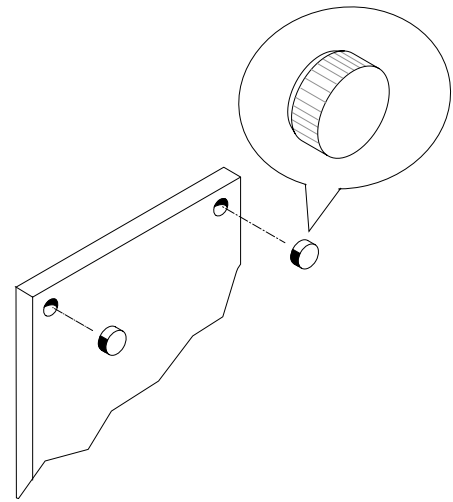

ART.
4CN.TA1.0000 .xx (4 PZ) Art. 4CN.435, 4CN.447, 4CN.441
4CN.TA2.0000 .xx (3 PZ) Art. 4CN.445

- Tappi copriforo in poliammide PA6 per placca a muro
- Caps in PA6 polyamide for wall plate
- Cache-trous en polyamide PA6 pour plaque murale
- Tapas embellecedoras de poliamida PA6 para placa en pared

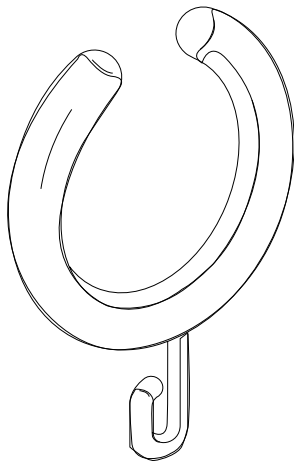

ART.
4CN.0AN.0002 .xx

- Anello reggitenda
- Shower curtain ring
- Anneau pour rideau de douche
- Anillas para cortina

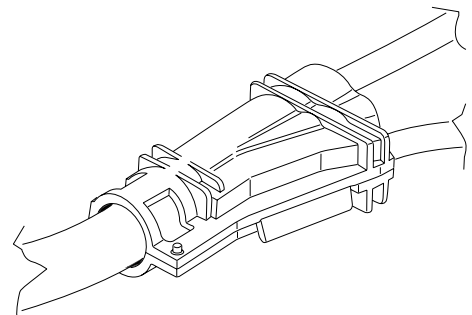

ART.
4CN.0IP.0068.00

- Giunzione rapida per cavi elettrici
- Quick junction for electric cables
- Jonction rapide pour cables électriques
- Kit conector para cables eléctricos

CE
IP 68

THESE PRODUCTS CONTRIBUTE TO LEED® CREDITS

.XX FINISH	.A1	.01	.02	.03	.04	.05	.07	.09	.10	.17
LRV										
		87	76	65		27	9	5		

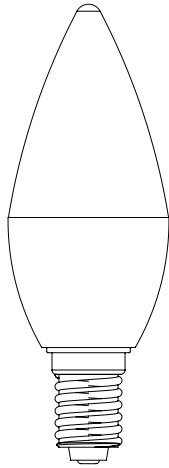

ART.
4CN.407.00LT.00

- Lampadina LED di classe energetica A+
- Light LED bulb energy class A+
- Ampoule LED de classe énergétique A+
- Bombilla LED de eficiencia energética A+

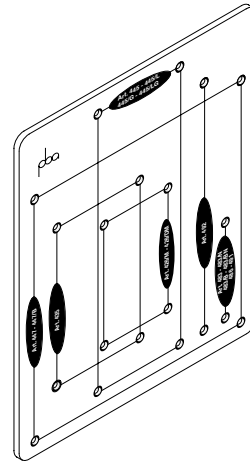

ART.
4CN.499.0000.00

- Dima per il montaggio
- Sketch for wall mounting
- Gabarit
- Plantilla para montaje

THESE PRODUCTS CONTRIBUTE TO LEED® CREDITS

PROGRAMMA PBA WF

PATENT PENDING ITALY 102019000013932
PATENT DEUTCHLAND 202020104488.5

PBA
PATENTED
SYSTEM

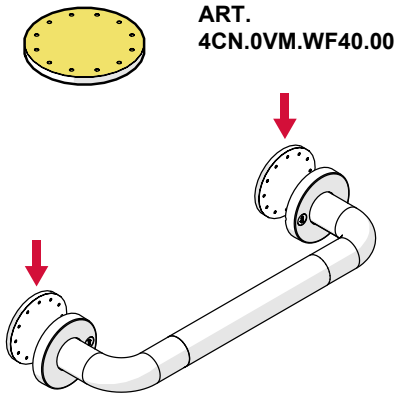
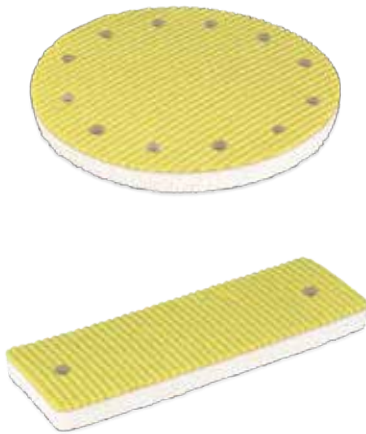

Articles with fixing rose

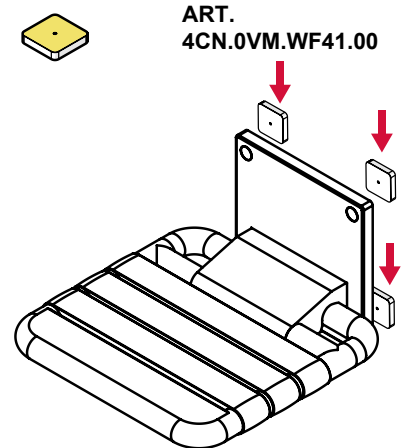

Shower seat with plate and lift-up support

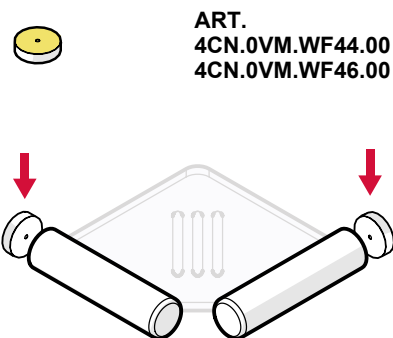

Bathroom shelf 400-NY and 400-SS

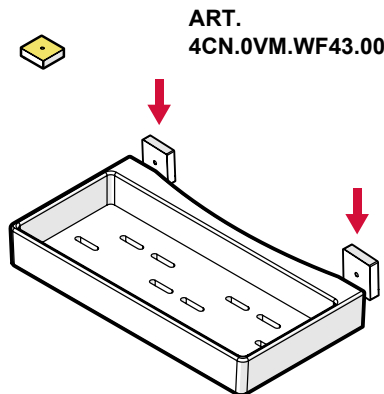

Bathroom shelf 400-NY and CAP

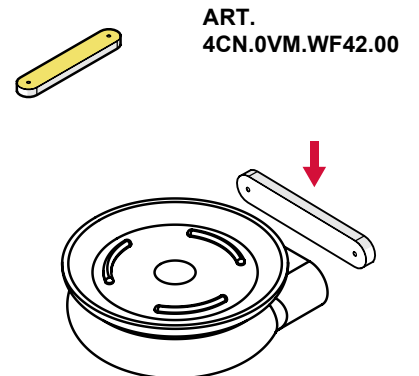

Universal support 400-NY

PROGRAMMA 400-ALU





ALLUMINIO EN-AW 6060 - ALUMINUM ALLOY EN-AW 6060 - ALUMINIUM EN-AW 6060 - ALUMINIO EN-AW 6060

LA LEGA DI ALLUMINIO EN-AW 6060 È UNA LEGA A MEDIA RESISTENZA, HA UN'OTTIMA RESISTENZA ALLA CORROSIONE, OTTIMA SALDABILITÀ E BUONA RESISTENZA ALLE BASSE TEMPERATURE. È COMUNEMENTE USATA PER REALIZZARE ELEMENTI ANCHE CON FORMA COMPLESSA E RISULTA MOLTO BUONA NEI PROCESSI DI ANODIZZAZIONE.

THE ALUMINUM EN-AW 6060 ALLOY HAS AN EXCELLENT RESISTANCE TO CORROSION, TO LOW TEMPERATURES AND ALLOWS QUALITY WELDINGS. IN THE DESIGN WORLD IT IS COMMONLY USED TO CREATE COMPONENTS WITH COMPLEX SHAPES ALLOWING EXCELLENT QUALITY RESULTS COMPARED TO OTHER ALLOYS FOR ANODIZING TREATMENTS.

L'ALLIAGE D'ALUMINIUM EN-AW 6060 EST UN ALLIAGE POUVANT ÊTRE TRAITÉ THERMIQUEMENT DE RÉSISTANCE MOYENNE. IL PRÉSENTE UNE TRÈS BONNE RÉSISTANCE À LA CORROSION, UNE TRÈS BONNE SOUDABILITÉ ET UNE BONNE FORMABILITÉ À FROID. IL EST COURAMMENT UTILISÉ POUR LES SECTIONS COMPLEXES ET PRÉSENTE UNE TRÈS BONNE RÉPONSE AU PROCESSUS D'ANODISATION.

LA ALEACIÓN DE ALUMINIO EN-AW 6060 ES UNA ALEACIÓN QUE SE PUEDE TRATAR CON CALOR DE RESISTENCIA MEDIA. TIENE MUY BUENA RESISTENCIA A LA CORROSIÓN, MUY BUENA SOLDABILIDAD Y BUENA CONFORMABILIDAD EN FRÍO. SE USA COMÚNMENTE PARA CORTES TRANSVERSALES COMPLEJOS Y TIENE UNA RESPUESTA DE ANODIZACIÓN MUY BUENA.

pba ANTI-MICROBIAL COATING

A M C

I PRODOTTI IN ALLUMINIO HANNO PROPRIETÀ ANTIBATTERICHE NATURALI E UNA BUONA MANEGGEVOLEZZA PER LA PULIZIA. IL RIVESTIMENTO ANTIMICROBICO pba (AMC) È UNA FINITURA INNOVATIVA ALTAMENTE CONSIGLIATA PER TUTTE LE SITUAZIONI IN CUI L'IGIENE È ESTREMAMENTE IMPORTANTE NON SOLO PER LA DESTINAZIONE, MA ANCHE PER L'ALTA FREQUENTAZIONE COME GLI OSPEDALI E SPAZI PUBBLICI IN GENERE. AMC È DISPONIBILE PER TUTTE LE SERIE ALLUMINIO SU RICHIESTA.

IL RIVESTIMENTO ANTIMICROBICO pba (AMC) CONTIENE ADDITIVI SPECIALI CHE RENDONO LA SUPERFICIE PROTETTA DA BATTERI E MICRORGANISMI. I TEST DIMOSTRANO CHE SU SUPERFICI NON TRATTATE MICROBI E BATTERI POSSONO PROLIFERARE FACILMENTE MENTRE SULLE SUPERFICI TRATTATE LA PROLIFERAZIONE È PRATICAMENTE RIDOTTA A ZERO.

PRODUCTS IN ALUMINUM HAVE NATURAL ANTIBACTERIAL PROPERTIES AND A GOOD HANDLE ON CLEANLINESS. pba ANTI-MICROBIAL COATING (AMC) IS AN INNOVATIVE FINISHING HIGHLY RECOMMENDED FOR ALL SITUATIONS WHERE HYGIENE IS EXTREMELY IMPORTANT NOT ONLY FOR THE DESTINATION, BUT ALSO FOR THE HIGH ATTENDANCE LIKE HOSPITALS AND GENERALLY PUBLIC AND SPACES. AMC IS AVAILABLE FOR ALL THE ALUMINIUM SERIES ON REQUEST. THE pba ANTI-MICROBIAL COATING (AMC) SURFACE FINISHING CONTAINS SPECIAL ADDITIVES THAT MAKE THE SURFACE PROTECTED FROM BACTERIA AND MICROORGANISMS. THE TESTS SHOW THAT ON UNTREATED SURFACES THE MICROBES AND BACTERIA CAN EASILY PROLIFERATE WHILE ON THE TREATED SURFACES THE BACTERIAL PROLIFERATION IS PRACTICALLY ZEROED.

LES PRODUITS EN ALUMINIUM ONT DES PROPRIÉTÉS ANTI-MICROBIENNES NATURELLES ET PERMETTENT UNE PROPRIÉTÉ FACILE. LE REVÊTEMENT ANTI-MICROBIEN pba (AMC) EST UNE FINITION INNOVANTE HAUTEMENT RECOMMANDÉE POUR TOUTES LES ESPACES OÙ L'HYGIÈNE EST EXTRÊMEMENT IMPORTANTE PAS SEULEMENT POUR LE BUT MÊME, MAIS AUSSI POUR LA HAUTE FRÉQUENTATION COMME LES HÔPITAUX, BUREAUX, HÔTELS ET ESPACES PUBLICS GÉNÉRAUX. LE RAM EST DISPONIBLE POUR TOUS LES SÉRIES EN ALUMINIUM À LA DEMANDE. LE REVÊTEMENT ANTI-MICROBIEN pba (AMC) CONTIENT DES ADDITIFS SPÉCIAUX QUI PROTÈGENT LA SURFACE CONTRE LES BACTÉRIES ET LES MICROORGANISMES. LES TESTS MONTRENT QUE SUR LES SURFACES TRAITÉES LA PROLIFÉRATION BACTÉRIENNE EST RÉDUITE PRATIQUEMENT À ZÉRO.

LOS PRODUCTOS DE ALUMINIO TIENEN PROPIEDADES ANTIBACTERIANAS NATURALES Y PERMITEN LIMPIAR FÁCILMENTE. EL RECUBRIMIENTO ANTI-MICROBIANO pba (AMC) ES UN ACABADO INNOVADOR RECOMENDADO PARA TODAS LAS SITUACIONES EN LAS QUE LA HIGIENE ES MUY IMPORTANTE NO SOLO PARA EL AMBIENTE, SINO TAMBIÉN PARA LA ALTA PRESENCIA, COMO HOSPITALES, OFICINAS, HOTELES Y EN GENERAL ESPACIOS PÚBLICOS. EL ACABADO AMC ESTÁ DISPONIBLE PARA LAS SERIES DE ALUMINIO BAJO PETICIÓN.

EL RECUBRIMIENTO ANTI-MICROBIANO pba (AMC) CONTIENE ADITIVOS ESPECIALES QUE HACEN PROTEGER LA SUPERFICIE CONTRA LAS BACTERIAS Y LOS MICROORGANISMOS. LAS PRUEBAS HAN DEMOSTRADO QUE LA PROLIFERACIÓN DE BACTERIAS SOBRE LAS SUPERFICIES TRATADAS ES REDUCIDA A CERO.







MULTI-RESISTANT
PATHOGENS DEVELOP
WITHOUT pba AMC

pba AMC REDUCES
PATHOGENS BY
ABOUT 99.99%

STANDARD

**.70
LIGHT BRONZE**

-  **RAIL**
Aluminum anodized
Light Bronze
-  **ACCESSORIES**
Polyamide 6 Grey
-  **SUPPORT AND BENDS**
Powder-coated
Aluminum Alloy and Zamak Grey
-  **AMC .A0**
Transparent
Light Bronze

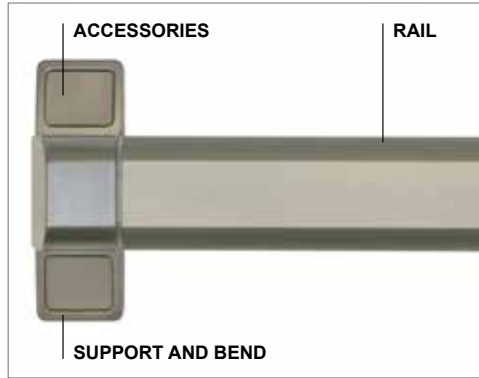





**.70
GREY**

-  **ACCESSORIES**
Polyamide 6



**.71
SILVER**

-  **RAIL**
Aluminum anodized silver
-  **ACCESSORIES**
Polyamide 6 White
-  **SUPPORT AND BENDS**
Powder-coated
Aluminum Alloy and Zamak White
-  **AMC .A2**
Transparent
Silver

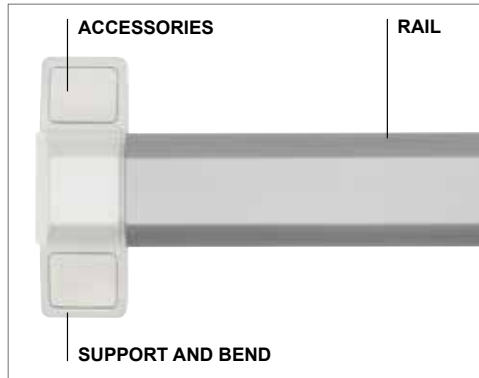





**.71
WHITE**

-  **ACCESSORIES**
Polyamide 6



UPON REQUEST - ON MINIMUM LOT TO BE AGREED

**.79
DARK BRONZE**

-  **RAIL**
Aluminum anodized
-  **SUPPORT AND BENDS**
Powder-coated
-  **ACCESSORIES**
Polyamide 6
-  **AMC .A9**
Transparent
Dark Bronze
On minimum lot to be agreed

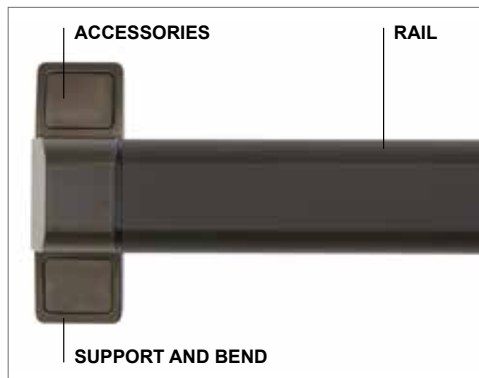





**.17
ANTHRACITE**

-  **ACCESSORIES**
Polyamide 6



**.73
BLACK**

-  **RAIL**
Aluminum anodized
-  **SUPPORT AND BENDS**
Powder-coated
-  **ACCESSORIES**
Polyamide 6
-  **AMC .A3**
Transparent
Black
On minimum lot to be agreed



**.10
BLACK**

-  **ACCESSORIES**
Polyamide 6



pba PER LA CERTIFICAZIONE LEED®

LEED® (LEADERSHIP IN ENERGY ENVIRONMENTAL DESIGN) È UN SISTEMA DI CERTIFICAZIONE A BASE VOLONTARIA PER LA GESTIONE, LA PROGETTAZIONE E LA COSTRUZIONE DI EDIFICI SOSTENIBILI DAL PUNTO DI VISTA SOCIALE, AMBIENTALE, ECONOMICO E DEL BENESSERE PER GLI UTILIZZATORI.





I PRODOTTI pba CONTRIBUISCONO AI PREREQUISITI E AI CREDITI LEED®.

PROCESSO INTEGRATO	IP	
MATERIALI E RISORSE	MR	
QUALITÀ DELL'AMBIENTE INTERNO	EQ	
INNOVAZIONE	I	

pba FOR LEED® CERTIFICATION

LEED® (LEADERSHIP IN ENERGY ENVIRONMENTAL DESIGN) IS A VOLUNTARY CERTIFICATION SYSTEM FOR THE MANAGEMENT, DESIGN AND CONSTRUCTION OF BUILDINGS THAT ARE SUSTAINABLE FROM A SOCIAL, ENVIRONMENTAL AND ECONOMIC POINT OF VIEW AND IN TERMS OF THE WELLBEING OF THE USERS.

pba PRODUCTS CONTRIBUTE TOWARD SATISFYING PREREQUISITES AND CREDITS UNDER LEED®.

INTEGRATED PROCESS	IP	
MATERIALS AND RESOURCES	MR	
INDOOR ENVIRONMENTAL QUALITY	EQ	
INNOVATION	I	

pba POUR LA CERTIFICATION LEED®

LEED® (LEADERSHIP IN ENERGY ENVIRONMENTAL DESIGN) EST UN SYSTÈME DE CERTIFICATION À BASE VOLONTAIRE POUR LA GESTION, LA CONCEPTION ET LA CONSTRUCTION DE BÂTIMENTS DURABLES D'UN POINT DE VUE SOCIAL, ENVIRONNEMENTAL, ÉCONOMIQUE ET DU BIEN-ÊTRE POUR LES UTILISATEURS.

LES PRODUITS pba CONTRIBUENT AUX CONDITIONS PRÉALABLES REQUISES ET AUX CRÉDITS LEED®.

PROCESSUS DE CONCEPTION INTÉGRÉE	IP	
MATÉRIAUX ET RESSOURCES	MR	
QUALITÉ DES ENVIRONNEMENTS INTÉRIEURS	EQ	
INNOVATION	I	

pba PARA LA CERTIFICACIÓN LEED®

LEED® (LEADERSHIP IN ENERGY ENVIRONMENTAL DESIGN) ES UN SISTEMA DE CERTIFICACIÓN DE BASE VOLUNTARIA PARA LA GESTIÓN, EL DISEÑO Y LA CONSTRUCCIÓN DE EDIFICIOS SOSTENIBLES DESDE EL PUNTO DE VISTA SOCIAL, MEDIOAMBIENTAL, ECONÓMICO Y DEL BIENESTAR PARA LOS USUARIOS.

LOS PRODUCTOS pba CONTRIBUYEN EN LOS PRE-REQUISITOS Y EN LOS CRÉDITOS LEED®.

PROCESO INTEGRADO	IP	
MATERIALES Y RECURSOS	MR	
CALIDAD DEL AMBIENTE INTERNO	EQ	
INNOVACIÓN	I	

CHART OF PBA PRODUCTS CONTRIBUTION TO LEED V4

INTEGRATIVE PROCESS

- IP PREREQUISITE INTEGRATIVE PROCESS PLANNING AND DESIGN





MATERIALS AND RESOURCES

- MR PREREQUISITE CONSTRUCTION AND DEMOLITION WASTE MANAGEMENT PLANNING
- MR CREDIT CONSTRUCTION AND DEMOLITION WASTE MANAGEMENT
- MR CREDIT BUILDING PRODUCT DISCLOSURE AND OPTIMIZATION - SOURCING OF RAW MATERIALS
➔ OPTION 2 LEADERSHIP EXTRACTION PRACTICES
- MR CREDIT BUILDING PRODUCT DISCLOSURE AND OPTIMIZATION - MATERIAL INGREDIENTS
➔ OPTION 2 MATERIAL INGREDIENT OPTIMIZATION

INDOOR ENVIRONMENTAL QUALITY

- EQ CREDIT LOW EMITTING MATERIALS
- EQ CREDIT CONSTRUCTION AIR QUALITY MANAGEMENT PLAN

INNOVATION

- IN PILOT CREDIT  DESIGN FOR FLEXIBILITY
- IN PILOT CREDIT  SOCIAL EQUITY
- IN PILOT CREDIT  INCLUSIVE DESIGN
- IN CREDIT  DESIGN FOR DECONSTRUCTION

SOSTEGNI DI SICUREZZA
SAFETY SUPPORTS
BARRES D'APPUI
ASIDEROS

Page 118



AUSILI DI SICUREZZA RIBALTABILI
LIFT-UP SAFETY SUPPORTS
BARRES D'APPUI RELEVABLES
ASIDEROS ABATIBLES

Page 126

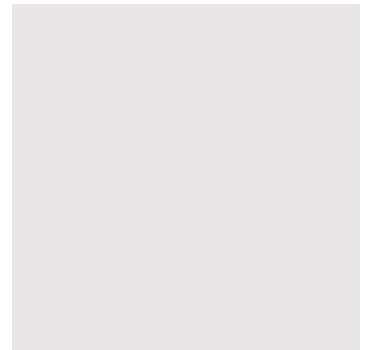

SEGGIOLINI
SEATS
SIÈGES
ASIENTOS

Page 130



ACCESSORI BAGNO
BATHROOM ACCESSORIES
ACCESSOIRES DE BAIN
ACCESORIOS DE BAÑO

Page 134



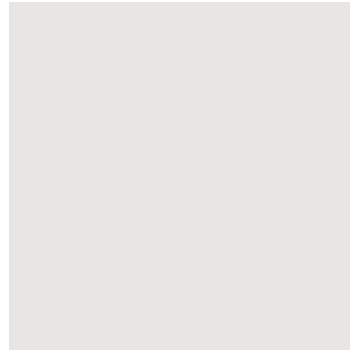
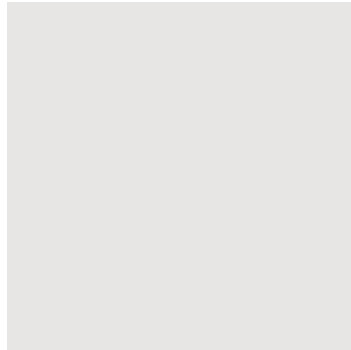
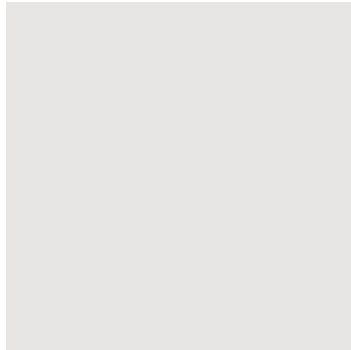
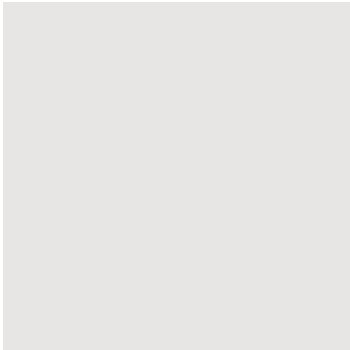
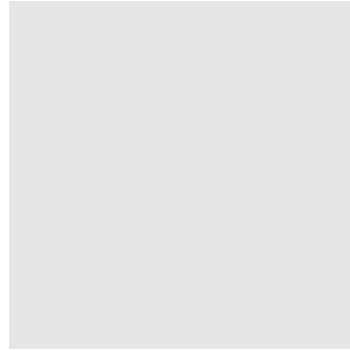
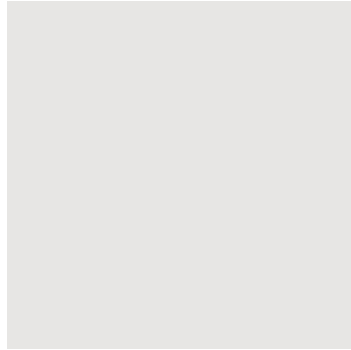
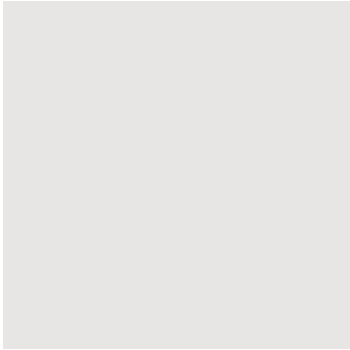
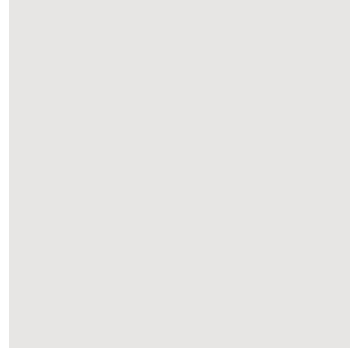
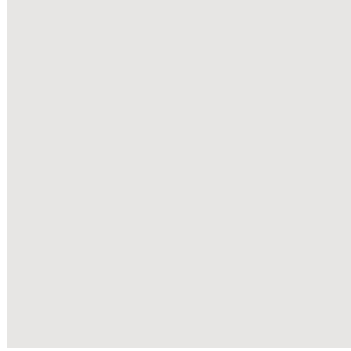
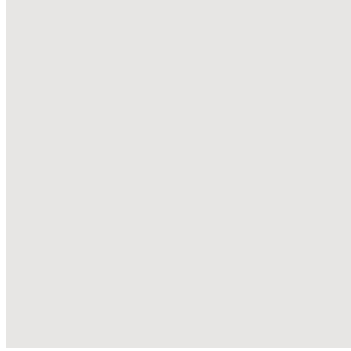
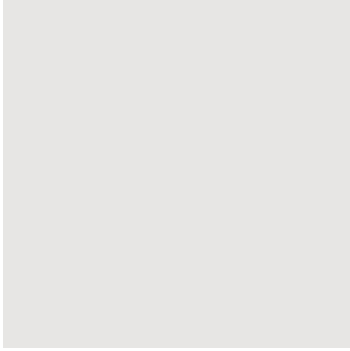
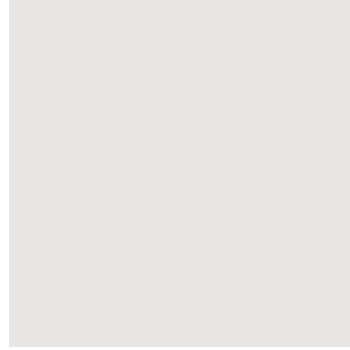
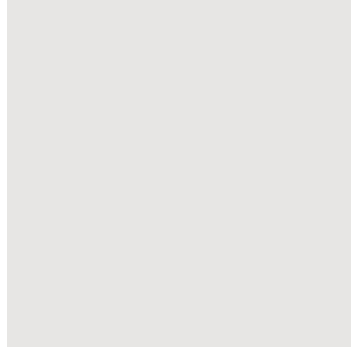
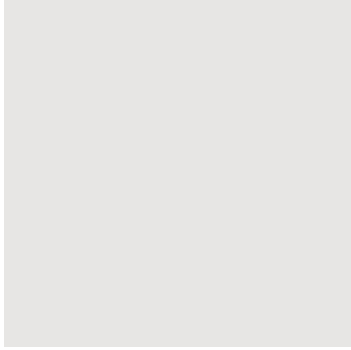
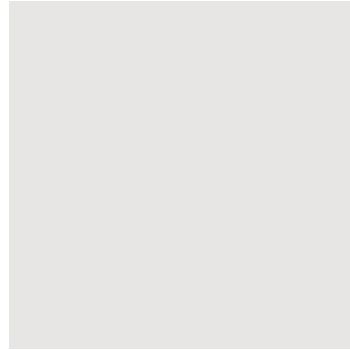
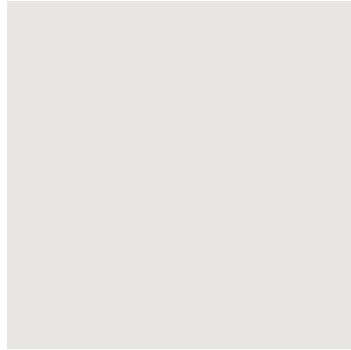
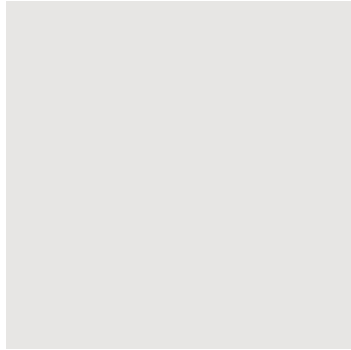
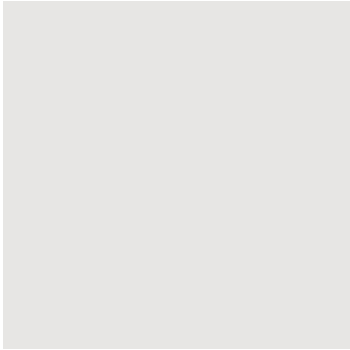





◆ RIGHT

ART.	◆	A	B
▲ 4CA.422.0000 .xx .x		220 (277)*	520 (577)*
🔩 4CA.22J.0000 .xx .x			
🔩 4CA.22Y.0000 .xx .x			
▲ 4CA.422.000M .xx .x		300 (357)*	520 (577)*
🔩 4CA.22J.000M .xx .x			
🔩 4CA.22Y.000M .xx .x			
▲ 4CA.422.000L .xx .x		320 (377)*	720 (777)*
🔩 4CA.22J.000L .xx .x			
🔩 4CA.22Y.000L .xx .x			
4CA.422.5075 .xx .x		500 (557)*	750 (807)*
🔩 4CA.22J.5075 .xx .x			
🔩 4CA.22Y.5075 .xx .x			

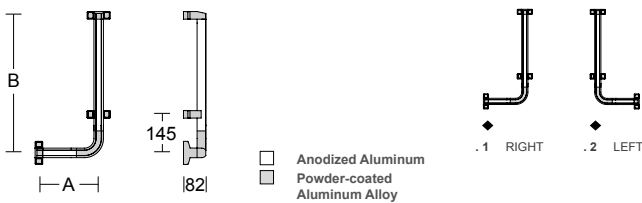

□ Anodized Aluminum
 ■ Powder-coated Aluminum Alloy

ART.	◆	A	B
▲ 4CA.422.00LA .xx .x		400 (457)*	1160 (1217)*
🔩 4CA.22J.00LA .xx .x			
4CA.422.9999 .xx .x	⊙		⊙
🔩 4CA.22J.9999 .xx .x			

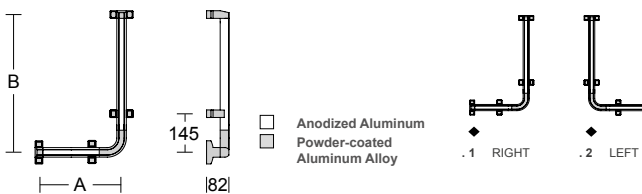

□ Anodized Aluminum
 ■ Powder-coated Aluminum Alloy

- Sostegno di sicurezza a "L"
- "L"-shaped safety support
- Barre d'appui forme à "L"
- Asidero en "L"



THESE PRODUCTS CONTRIBUTE TO LEED® CREDITS

.XX FINISH



.A0 AMC
 Transparent Light Bronze

.A2 AMC
 Transparent Silver

- ◆ .1 DESTRO RIGHT DROITE DERECHA
- .2 SINISTRO LEFT GAUCHE IZQUIERDA



ART.	A	B
▲ 4CA.433.0000 .xx	1570 (1598)*	820 (877)*
🔩 4CA.33J.0000 .xx		
🔩 4CA.33Y.0000 .xx		
4CA.433.000L .xx	1570 (1598)*	1160 (1215)*
🔩 4CA.33J.000L .xx		
🔩 4CA.33Y.000L .xx		
4CA.433.9999 .xx	⊙	⊙
🔩 4CA.33J.9999 .xx		
🔩 4CA.33Y.9999 .xx		

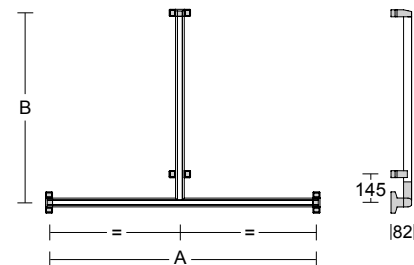

□ Anodized Aluminum
 ■ Powder-coated Aluminum Alloy

- Sostegno di sicurezza a "T"
- "T"-shaped safety support
- Barre d'appui forme à "T"
- Asidero en "T"





ART.	◆	A	B	C	D
▲ 4CA.424.0000 .xx .x		660 (674)*	660 (702)*	820 (877)*	498
🔧 4CA.24J.0000 .xx .x					
▲ 4CA.424.000L .xx .x		760 (774)*	400 (442)*	1160 (1217)*	-
🔧 4CA.24J.000L .xx .x					
▲ 4CA.424.00LA .xx .x		760 (774)*	760 (802)*	1160 (1217)*	598
🔧 4CA.24J.00LA .xx .x					
4CA.424.9999 .xx .x	Ⓢ				
🔧 4CA.24J.9999 .xx .x					

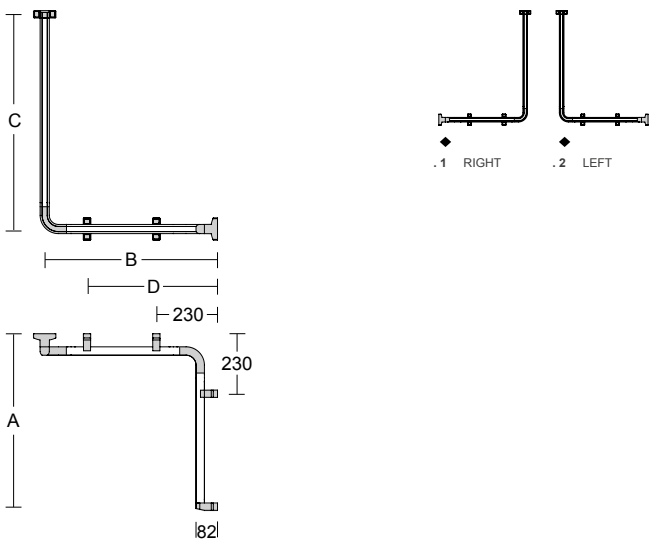

□ Anodized Aluminum
 □ Powder-coated Aluminum Alloy

- Sostegno di sicurezza ad angolo con impugnatura verticale
- Corner safety support with shower head rail
- Barre d'appui à coin avec barre de douche
- Asidero en ángulo con empuñadura vertical

THESE PRODUCTS CONTRIBUTE TO LEED® CREDITS

.XX FINISH



.A0
 AMC
 Transparent
 Light Bronze

.A2
 AMC
 Transparent
 Silver



ART.	◆	A	B	C
▲ 4CA.443.000B .xx .x		760 (774)*	760 (774)*	1160 (1217)*
🔧 4CA.43J.000B .xx .x				
▲ 4CA.443.00BL .xx .x		760 (774)*	1184 (1198)*	1160 (1217)*
🔧 4CA.43J.00BL .xx .x				
4CA.443.00BM .xx .x		920 (934)*	920 (934)*	1160 (1217)*
🔧 4CA.43J.00BM .xx .x				
4CA.443.999B .xx .x	Ⓢ			
🔧 4CA.43J.999B .xx .x				

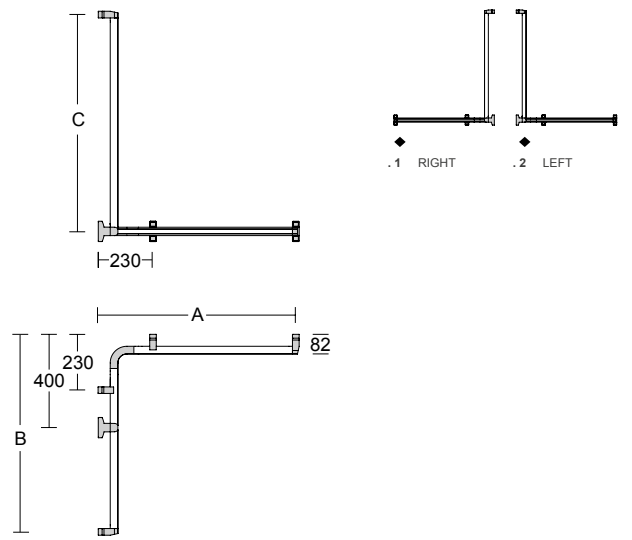

□ Anodized Aluminum
 □ Powder-coated Aluminum Alloy

- Sostegno di sicurezza ad angolo con impugnatura verticale
- Corner safety support with shower head rail
- Barre d'appui à coin avec barre de douche
- Asidero en ángulo con empuñadura vertical

◆
 .1 DESTRO RIGHT DROITE DERECHA
 .2 SINISTRO LEFT GAUCHE IZQUIERDA





ART.	A
▲ 4CA.487.0000 .xx	570 (598)*
▲ 4CA.487.000A .xx	770 (798)*
▲ 4CA.487.000B .xx	970 (998)*
▲ 4CA.487.000C .xx	1170 (1198)*
4CA.487.9999 .xx	Ⓢ

ART.	A	B
4CA.487.00RD .xx	140*	93*

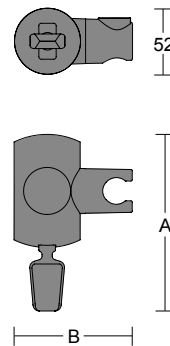
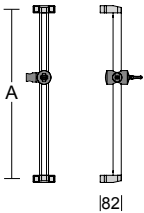

- Anodized Aluminum
- Powder-coated Aluminum Alloy
- Polyamide 6

- Polyamide 6

- Sostegno di sicurezza con reggisoffione
- Fixed safety support with shower head holder
- Barre d'appui fixe avec curseur de douchette
- Asidero con soporte para ducha regulable en altura



- Reggisoffione girevole con attacco conico universale a scorrimento compatibile con sostegni di sicurezza del PROGRAMMA ALU
- Rotating shower head holder with universal sliding tapered connection compatible with all safety supports of the PROGRAMMA ALU
- Curseur de douche rabatable avec élément de fixation mobile et conique universel compatible avec les barres d'appui du PROGRAMMA ALU
- Soporte ducha giratorio con base cónica universal deslizable compatible con todos los asideros del PROGRAMA ALU

THESE PRODUCTS CONTRIBUTE TO LEED® CREDITS

.XX FINISH





ART.	A
▲ 4CA.440.0000 . xx	370 (398)*
▲ 4CA.40Y.0000 . xx	
▲ 4CA.440.000A . xx	570 (598)*
▲ 4CA.40Y.000A . xx	
▲ 4CA.440.000B . xx	770 (798)*
▲ 4CA.40Y.000B . xx	
▶ ▲ 4CA.440.000C . xx	970 (998)*
▲ 4CA.40Y.000C . xx	
▲ 4CA.440.000Z . xx	300 (328)*
▲ 4CA.40Y.000Z . xx	
4CA.440.9999 . xx	
4CA.40Y.9999 . xx	

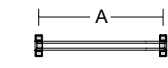

- Anodized Aluminum
- Powder-coated Aluminum Alloy

- Sostegno di sicurezza orizzontale
- Horizontal safety support
- Barre d'appui horizontale
- Asidero horizontal



THESE PRODUCTS CONTRIBUTE TO LEED® CREDITS

.XX FINISH

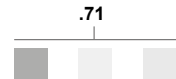
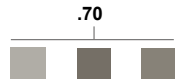

.A0
AMC
Transparent
Light Bronze

.A2
AMC
Transparent
Silver



ART.	A
▲ 4CA.423.000B . xx	1370 (1398)*
▶ ▲ 4CA.423.00BL . xx	1570 (1598)*
4CA.423.999B . xx	

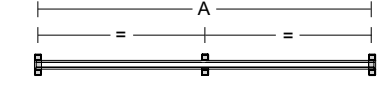

- Anodized Aluminum
- Powder-coated Aluminum Alloy

- Sostegno di sicurezza orizzontale con supporto intermedio
- Horizontal safety support with intermediate wall support
- Barre d'appui horizontale avec support intermédiaire
- Asidero horizontal con soporte intermedio





◆ LEFT

ART.	A
▲ 4CA.442.0000 . xx	760 (774)*
▲ 4CA.442.000M . xx	960 (974)*
▶▲ 4CA.442.000L . xx	1160 (1174)*
4CA.442.9999 . xx	

ART.	◆	A	B
▲ 4CA.427.0000 . xx . x		500 (514)*	300 (314)*
4CA.27Y.0000 . xx . x			

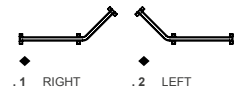
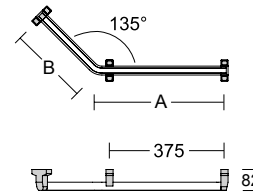
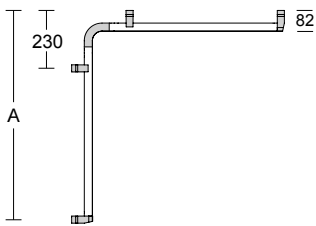
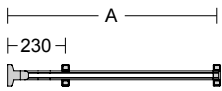

- Anodized Aluminum
- Powder-coated Aluminum Alloy

- Anodized Aluminum
- Powder-coated Aluminum Alloy

- Sostegno di sicurezza ad angolo simmetrico
- Symmetric corner safety support
- Barre d'appui à coin symétrique
- Asidero en ángulo simétrico

- Sostegno di sicurezza fisso aperto
- Open fixed safety support
- Barre d'appui fixe coudée
- Asidero fijo en ángulo



THESE PRODUCTS CONTRIBUTE TO LEED® CREDITS

.XX FINISH

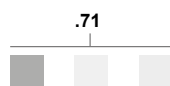
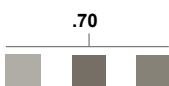

.A0
AMC
Transparent
Light Bronze

.A2
AMC
Transparent
Silver

- ◆ .1 DESTRO RIGHT DROITE DERECHA
- .2 SINISTRO LEFT GAUCHE IZQUIERDA



ART.	A
▲ 4CA.441.000P . xx	600*
▲ 4CA.441.00PL . xx	700*
▲ 4CA.441.0PLL . xx	850*

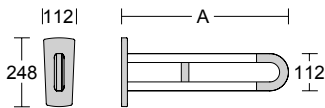

- Anodized Aluminum
- Powder-coated Aluminum Alloy

- Sostegno di sicurezza fisso su piastra
- Safety support fixed on plate
- Barre d'appui fixe sur plaque
- Asidero fijo sobre placa



THESE PRODUCTS CONTRIBUTE TO LEED® CREDITS

.XX FINISH

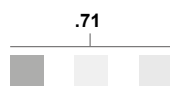
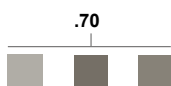

.A0
AMC
Transparent
Light Bronze

.A2
AMC
Transparent
Silver

.XX FINISH

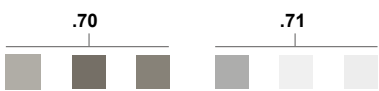





ART.	A
▲ 4CA.445.000T . xx	600*
▲ 4CA.45Y.000T . xx	
▲ 4CA.45K.000T . xx	
▲ 4CA.445.0000 . xx	700*
▲ 4CA.45Y.0000 . xx	
▲ 4CA.45K.0000 . xx	
▲ 4CA.445.000L . xx	850*
▲ 4CA.45Y.000L . xx	
▲ 4CA.45K.000L . xx	

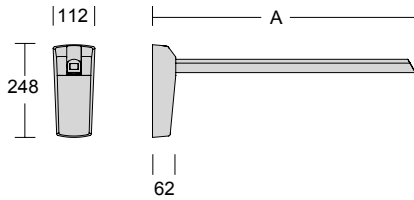

□ Powder-coated Aluminum Alloy

- Sostegno di sicurezza ribaltabile
- Lift-up safety support
- Barre d'appui rilevabile
- Asidero abatible



THESE PRODUCTS CONTRIBUTE TO LEED® CREDITS

.XX FINISH

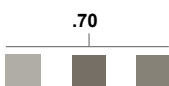

.71



.A0

AMC
Transparent
Light Bronze

.A2

AMC
Transparent
Silver

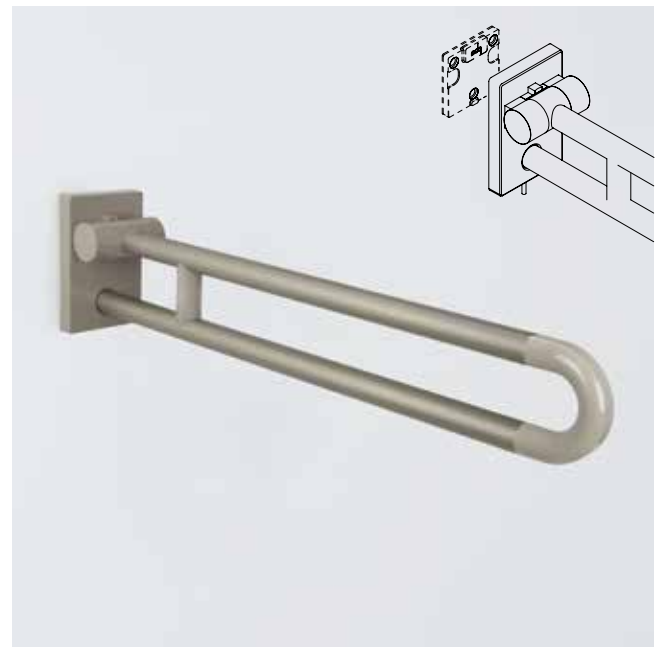

ART.	A
4CA.445.00CT . xx	600*
4CA.445.000C . xx	700*
4CA.445.00CL . xx	850*

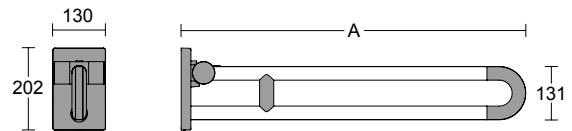
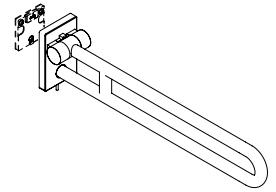

□ Anodized Aluminum
■ Polyamide 6

- Sostegno di sicurezza ribaltabile estraibile
- Extractable lift-up safety support
- Barre d'appui rilevabile amovibile
- Asidero abatible y extraíble





ART.
4CN.445.0CPM . 00

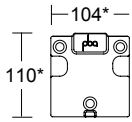

- Placca a muro per sostegno di sicurezza ribaltabile estraibile
- Wall plate for extractable lift-up safety support
- Plaque murale pour barre d'appui relevable amovible
- Placa en pared del asidero abatible y extraíble

THESE PRODUCTS CONTRIBUTE TO LEED® CREDITS



ART.
4CN.445.0CCP . xx

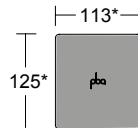

- Coperchio per placca a muro del sostegno di sicurezza ribaltabile estraibile
- Cover for wall plate of the extractable Lift-up safety support
- Couverture pour la plaque murale de la barre d'appui relevable amovible
- Tapa embellecedora para la placa en pared del asidero para baño abatible y extraíble

■ Polyamide 6

.XX FINISH



.XX FINISH

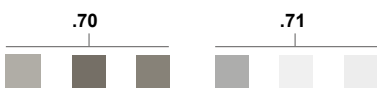





ART.	A	B
▲ 4CA.451.000B .xx	378*	400*
■ 4CA.51K.000B .xx	378*	400*

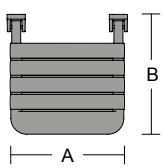
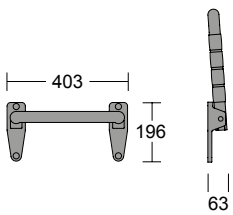

■ Polyamide 6

- Seggiolino ribaltabile
- Lift-up shower seat
- Siège relevable
- Asiento abatible



THESE PRODUCTS CONTRIBUTE TO LEED® CREDITS

.XX FINISH



ART.	A	B	C	D
4CA.450.00CM .xx	400*	510*	560*	316
4CA.450.0CML .xx	400*	510*	560*	386

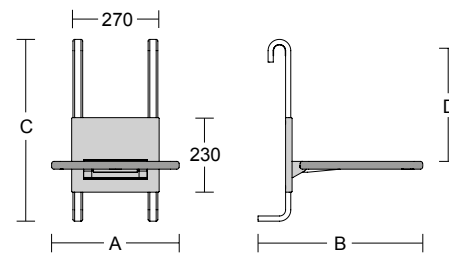

□ Anodized Aluminum
 □ Powder-coated Aluminum Alloy
 ■ Polyurethane

- Seggiolino agganciabile e ribaltabile
- Lift-up suspended seat
- Siège à suspendre et relevable
- Asiento suspendido y abatible





ART.	A	B
4CN.447.00CM . xx	400*	415*
4CN.47K.00CM . xx	400*	415*

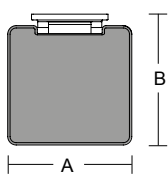
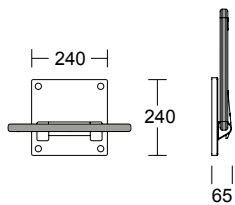

- Polyamide 6
- Polyurethane

- Seggiolino ribaltabile
- Lift-up shower seat
- Siège relevable
- Asiento abatible



THESE PRODUCTS CONTRIBUTE TO LEED® CREDITS

.XX FINISH



ART.	A	B	C
4CA.434.0000 . xx	490 (520)*	210*	200*
4CA.434.000L . xx	700 (730)*	210*	200*

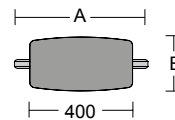

ART.	A	B	C
4CA.434.000R . xx	467 (496)* - 587 (616)*	210*	200*

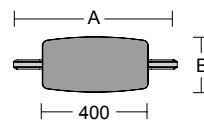

- Anodized Aluminum
- Powder-coated Aluminum Alloy
- Polyurethane

- Appoggiaschiena da WC
- WC Backrest
- Appui dos pour WC
- Respaldo de WC





.XX FINISH







ART.	A	
4CA.429.0000 .xx	800*	8
4CA.429.000A .xx	900*	9
4CA.429.000B .xx	1000*	10
4CA.429.000C .xx	1100*	11
4CA.429.000D .xx	1200*	12
4CA.429.000E .xx	1300*	13
4CA.429.9999 .xx		

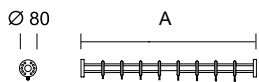

- Anodized Aluminum
- Polyamid 6

- Reggitenda dritto
- Straight shower curtain rail
- Barre de rideau de douche droit
- Barra de cortina de ducha recta

THESE PRODUCTS CONTRIBUTE TO LEED® CREDITS

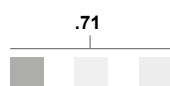
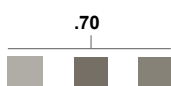

.XX FINISH



.A0
AMC
Transparent
Light Bronze

.A2
AMC
Transparent
Silver



ART.	A	B	
4CA.436.0000 .xx	800 (815)*	800 (815)*	16
4CA.436.9999 .xx			

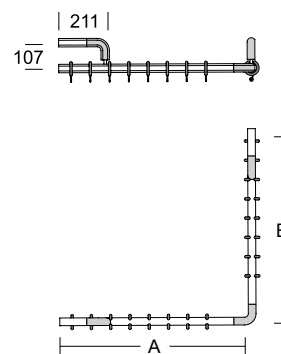

- Anodized Aluminum
- Powder-coated Aluminum Alloy
- Polyamid 6

- Reggitenda angolare con due supporti a muro
- Corner shower curtain rail with two wall supports
- Barre de rideau de douche à coin avec deux supports murales
- Barra de cortina de ducha en ángulo con dos soportes en pared



ART.	A	B	C	
4CA.436.000B .xx	800 (815)*	800 (815)*	440 (458)*	16
4CA.436.00BA .xx	900 (915)*	900 (915)*	440 (458)*	18
4CA.436.00BB .xx	1000 (1015)*	1000 (1015)*	440 (458)*	20
4CA.436.00BC .xx	1200 (1215)*	1200 (1215)*	440 (458)*	24
4CA.436.00BD .xx	1500 (1515)*	1500 (1515)*	440 (458)*	30
4CA.436.999B .xx				

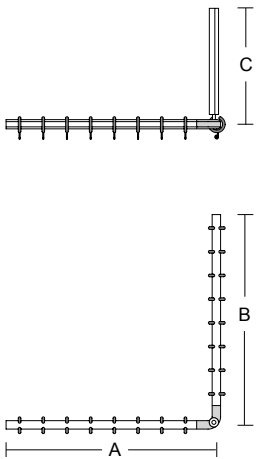

- Anodized Aluminum
- Powder-coated Aluminum Alloy
- Polyamide 6

- Reggitenda angolare con supporto a soffitto
- Corner shower curtain rail with ceiling support
- Barre de rideau de douche à coin avec support plafond
- Barra de cortina de ducha en ángulo con soporte de techo



ART.	A	B	C	
4CA.437.0000 .xx	800 (815)*	800 (830)*	440 (458)*	24
4CA.437.000A .xx	1000 (1015)*	1000 (1030)*	440 (458)*	30
4CA.437.9999 .xx				

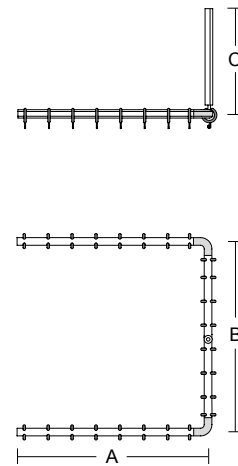

- Anodized Aluminum
- Powder-coated Aluminum Alloy
- Polyamide 6

- Reggitenda su tre lati con supporto a soffitto
- Three-sided shower curtain rail with ceiling support
- Barre de rideau de douche sur trois côtés avec support plafond
- Barra de cortina de ducha en "U" con soporte de techo

THESE PRODUCTS CONTRIBUTE TO LEED® CREDITS

.XX FINISH

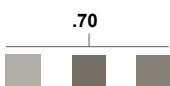

.71



.A0
AMC
Transparent
Light Bronze

.A2
AMC
Transparent
Silver



ART.	L	H	
4CN.0SC.000B.01	1200	2000	Art. 4CA.429.0000 .xx
			4CA.429.000A .xx
			4CA.429.000B .xx
			4CA.436.0000 .xx*
			4CA.436.000B .xx*
			4CA.436.00BA .xx*
4CN.0SC.000C.01	1800	2000	Art. 4CA.429.000C .xx
			4CA.429.000D .xx
			4CA.429.000E .xx
			4CA.436.00BC .xx*
			4CA.436.00BD .xx*
			4CA.437.0000 .xx*



ART.	L	H	
4CN.0SC.00BE.01	1200	2000	Art. 4CA.429.0000 .xx
			4CA.429.000A .xx
4CN.0SC.00FE.01	1500	2000	Art. 4CA.429.000B .xx
			4CA.429.000C .xx
			4CA.436.00BC .xx*
			4CA.437.0000 .xx*
4CN.0SC.00CE.01	1800	2000	Art. 4CA.429.000D .xx
			4CA.429.000E .xx
			4CA.436.00BD .xx*
			4CA.437.000A .xx*
4CN.0SC.00DE.01	2000	2000	Art. 4CA.436.0000 .xx
			4CA.436.000B .xx
4CN.0SC.00EE.01	2400	2000	Art. 4CA.436.00BA .xx
			4CA.436.00BB .xx

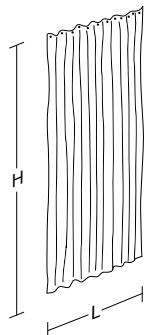

- Tenda ignifuga per doccia
- Fireproof shower curtain
- Rideau de douche ignifuge
- Cortina de ducha ignifuga

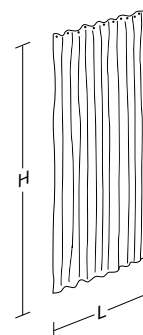

- Tenda impermeabile per doccia
- Waterproof shower curtain
- Rideau de douche imperméable
- Cortina de ducha impermeable

THESE PRODUCTS CONTRIBUTE TO LEED® CREDITS



ART.	A	B	C
4CA.490.00QR .xx	600*	700*	15
4CA.490.00AR .xx	600*	1100*	15

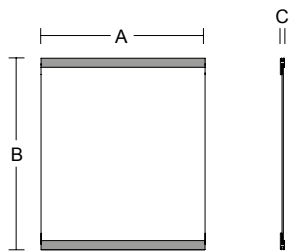

■ Anodized Aluminum

- Specchio fisso con cornice
- Fixed mirror with frame
- Miroir fixe avec cadre
- Espejo fijo con marco



ART.	A	B	C	α
4CA.470.0000 .xx	600*	540*	150*	14°
4CA.470.000Q .xx	600*	690*	190*	14°

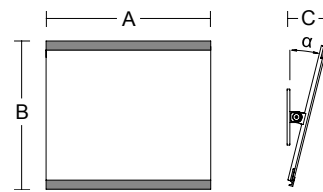

■ Anodized Aluminum

- Specchio orientabile con cornice
- Adjustable mirror with frame
- Miroir orientable avec cadre
- Espejo orientable con marco

THESE PRODUCTS CONTRIBUTE TO LEED® CREDITS

.XX FINISH

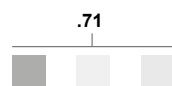
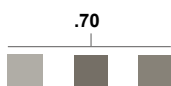

.A0
AMC
Transparent
Light Bronze

.A2
AMC
Transparent
Silver



ART.	A	B	C
4CA.001.0000.00	600*	800*	54,5

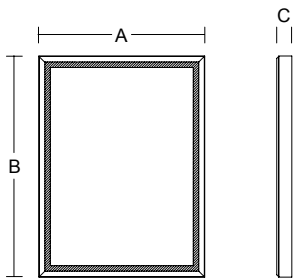

Aluminum Black

- Specchio fisso con cornice alluminio e luce led integrata
- Fixed mirror with aluminium frame and integrated led light
- Miroir fixe avec cadre en aluminium et éclairage led intégré
- Espejo fijo con marco de aluminio y luz led integrada

THESE PRODUCTS CONTRIBUTE TO LEED® CREDITS

.XX FINISH .00



ART.	A	B	C	α
4CA.002.0000.00	600*	800*	40*	11°

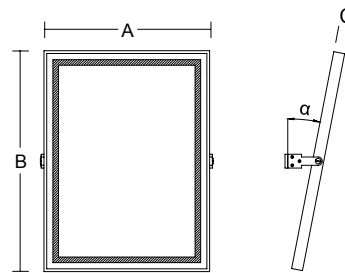

Aluminum Black

- Specchio orientabile con cornice alluminio e luce led integrata
- Adjustable mirror with aluminium frame and integrated led light
- Miroir orientable avec cadre en aluminium et éclairage led intégré
- Espejo orientable con marco de aluminio y luz led integrada

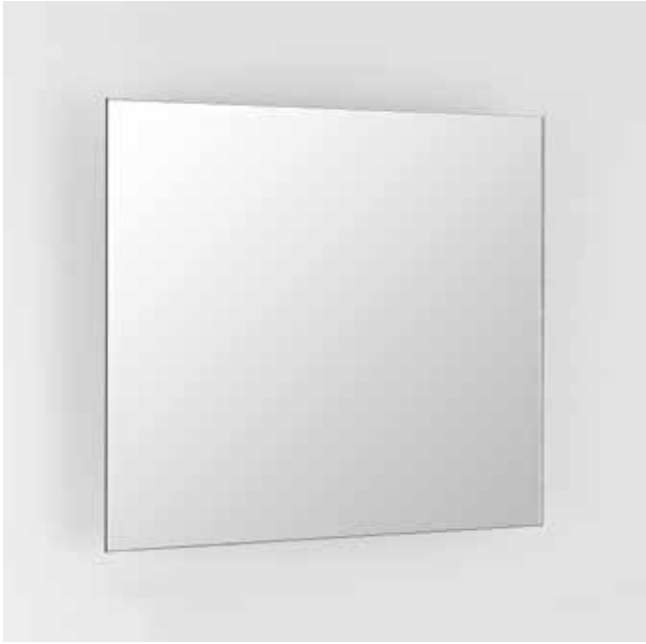

ART.	A	B	C	α
4CA.471.0000.00	600*	500*	160*	18°
4CA.471.000Q.00	600*	650*	210*	18°

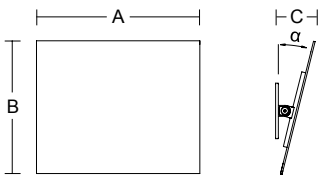

- Specchio orientabile senza cornice
- Adjustable mirror without frame
- Miroir orientable sans cadre
- Espejo orientable sin marco

THESE PRODUCTS CONTRIBUTE TO LEED® CREDITS

.XX FINISH



ART.	A	B	C
4CN.490.000R . xx	600*	500	550*
4CN.490.00QR . xx	600*	650	700*
4CN.490.00AR . xx	600*	950	1000*

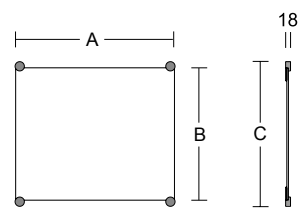

■ Polyamide 6

- Specchio fisso
- Fixed mirror
- Miroir fixe
- Espejo fijo



ART.	A	B
4CN.490.0WHR .xx	38	64

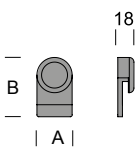

■ Polyamide 6

- Kit pinza reggispecchio per specchio fisso (4 pezzi)
- Kit mirror-holder supports for fixed mirror (4 pieces)
- Jeu supports porte-miroir pour miroir fixe (4 pièces)
- Juego pinza para anclar el espejo fijo (4 piezas)

THESE PRODUCTS CONTRIBUTE TO LEED® CREDITS

.XX FINISH



ART.	A	B
4CN.407.0TUA .xx	405*	61*

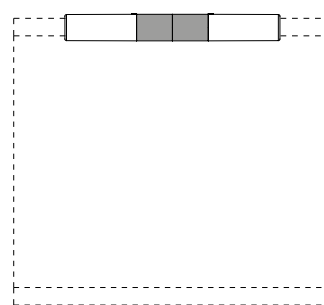
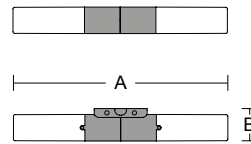

■ Polyamide 6

- Lampada da applicare su specchi con cornice.
IP 54 con Art. 4CN.0IP.0068.00
- Lamp for mirrors with frame.
IP 54 with Art. 4CN.0IP.0068.00
- Lampe pour miroirs avec cadre.
IP 54 avec Art. 4CN.0IP.0068.00
- Aplique para espejos con marco
IP 54 con Art. 4CN.0IP.0068.00

CE
IP 54



ART.	A	B
4CN.407.00TU .xx	405*	84*

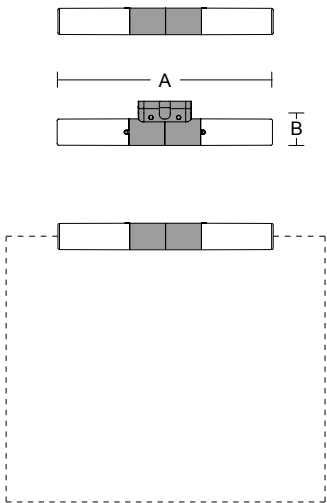

■ Polyamide 6

- Lampada da applicare su specchi senza cornice.
IP 54 con Art. 4CN.0IP.0068.00
- Lamp for mirrors without frame.
IP 54 with Art. 4CN.0IP.0068.00
- Lampe pour miroirs sans cadre.
IP 54 avec Art. 4CN.0IP.0068.00
- Aplique para espejos sin marco
IP 54 con Art. 4CN.0IP.0068.00

CE
IP 54

THESE PRODUCTS CONTRIBUTE TO LEED® CREDITS
.XX FINISH



ART.	A	B
4CN.407.0TUR .xx	405*	77*

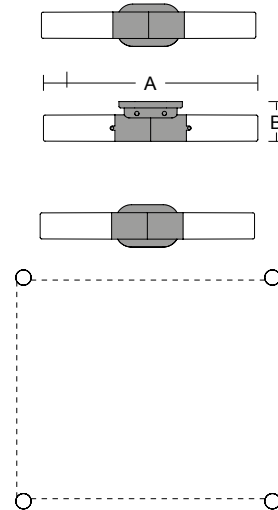

■ Polyamide 6

- Lampada da fissare a parete.
IP 54 con Art. 4CN.0IP.0068.00
- Wall lamp for mirror.
IP 54 with Art. 4CN.0IP.0068.00
- Lampe de mur pour miroir.
IP 54 avec Art. 4CN.0IP.0068.00
- Aplique con fijación en pared
IP 54 con Art. 4CN.0IP.0068.00

CE
IP 54



ART.	A	B
4CA.484.00AL .xx	600 (630)*	141* alluminio - aluminium - aluminium - aluminium
4CA.484.99AL .xx		141* alluminio - aluminium - aluminium - aluminium

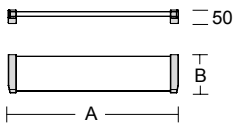

ART.	A	B
4CA.484.0BAL .xx	650 (680)*	150* alluminio - aluminium - aluminium - aluminium

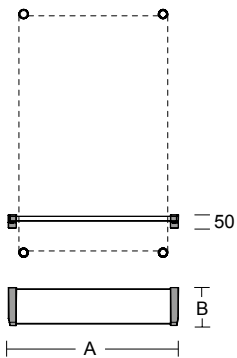

Anodized Aluminum
 Polyamide 6

- Mensola con ripiano in alluminio
- Aluminium bathroom shelf
- Tablette en aluminium
- Estante con repisa en aluminio



ART.	A	B
4CA.485.0IAL .xx	600 (630)*	141* aluminium
4CA.485.9IAL .xx		141* aluminium

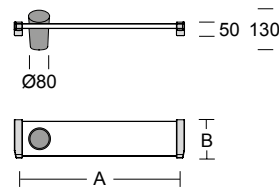

ART.	A	B
4CA.485.IBAL .xx	650 (680)*	150* aluminium

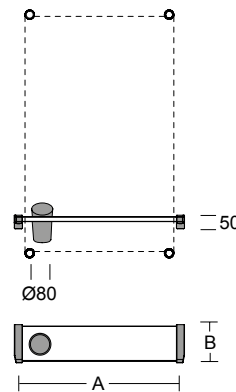

Anodized Aluminum
 Polyamide 6

- Mensola con ripiano in alluminio con bicchiere conico
- Aluminium bathroom shelf with conical tumbler
- Tablette en aluminium avec gobelet conique
- Estante con repisa en aluminio, con vaso cónico

THESE PRODUCTS CONTRIBUTE TO LEED® CREDITS

.XX FINISH

.70

.71





ART.	A	B	C
4CA.483.000N .xx	115*	123*	46*

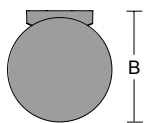
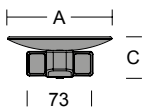

■ Polyamide 6

- Mensola con portasapone
- Shelf with soap dish
- Tablette avec porte-savon
- Estante con jabonera

THESE PRODUCTS CONTRIBUTE TO LEED® CREDITS

.XX FINISH



ART.	A	B	C
4CA.483.00BN .xx	80*	105*	131*

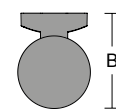
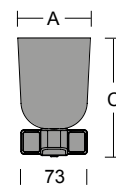

■ Polyamide 6

- Mensola con bicchiere
- Shelf with tumbler
- Tablette avec gobelet
- Estante con vaso



ART.	A	B	C
4CA.456.0000 .xx	80*	105*	173*

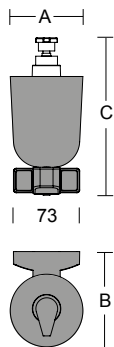

■ Polyamide 6

- Mensola con dispenser sapone
- Shelf with soap dispenser
- Tablette avec distributeur de savon
- Estante con dispensador de jabón (It 0,4)

THESE PRODUCTS CONTRIBUTE TO LEED® CREDITS

.XX FINISH



ART.	A	B	C
4CA.486.000C .xx	98*	114*	438*

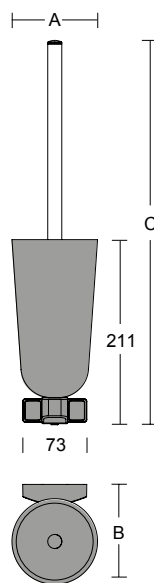

□ Anodized Aluminum
■ Polyamide 6

- Portascopino ad imbocco conico
- Conical toilet brush set
- Ensemble brosse WC conique
- Escobillero cónico



ART. A
4CN.486.000D .xx 555

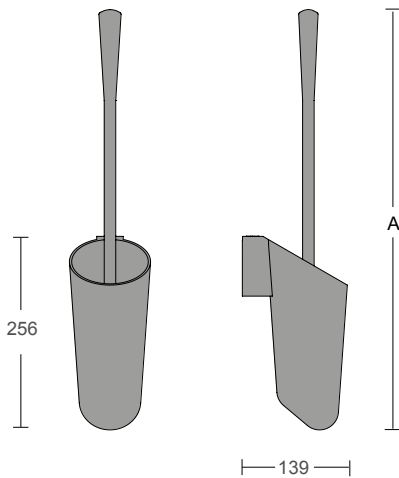

■ Polyamide 6

- Portascopino conico con attacco a muro integrato
- Conical toilet brush set with integrated wall fixing
- Ensemble brosse WC conique avec fixation murale intégrée
- Escobillero cónico con fijación en pared integrada

THESE PRODUCTS CONTRIBUTE TO LEED® CREDITS

.XX FINISH



ART. A B
4CA.481.0000 .xx 155* 80

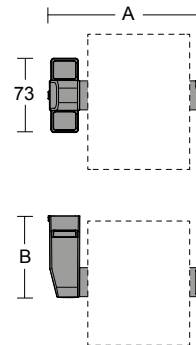

■ Polyamide 6

- Portarotolo a muro
- Wall toilet roll holder
- Porte-papier murale
- Portarrotolo de pared



ART.	A	B
4CA.481.00RL . xx	270*	80*

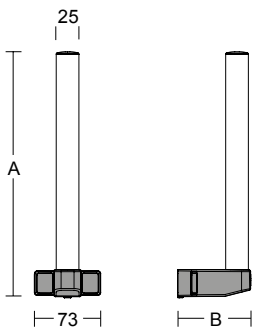

□ Anodized Aluminum
■ Polyamide 6

- Portarotolo di riserva
- Spare toilet roll holder
- Porte-papier de réserve
- Portarrollos de reserva

THESE PRODUCTS CONTRIBUTE TO LEED® CREDITS

.XX FINISH



ART.	A	B	C
4CA.492.000B . xx	210*	105*	103*

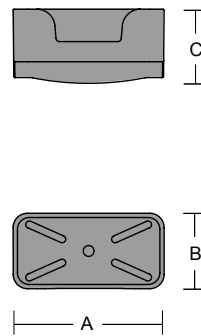

■ Polyamide 6

- Mensola applicabile su supporto orizzontale
- Shelf to be integrated to horizontal support
- Tablette accrochable à la barre d'appui horizontale
- Estante aplicable a asidero horizontal



ART.	A	B
4CA.489.000N .xx	370 (400)*	80*
4CA.489.00AN .xx	470 (500)*	80*
4CA.489.00BN .xx	570 (600)*	80*
4CA.489.00CN .xx	770 (800)*	80*
4CA.489.999N .xx	80*	80*

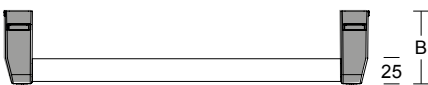
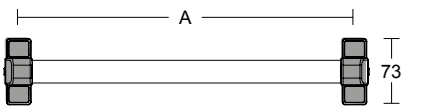

Anodized Aluminum
 Polyamide 6

- Portasciugamani
- Towel holder
- Porte-serviette
- Toallero

THESE PRODUCTS CONTRIBUTE TO LEED® CREDITS

.XX FINISH



ART.	A	B
4CN.488.000P .xx	Ø 52	47*

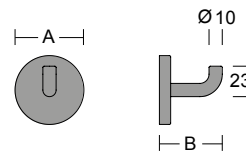

Polyamide 6

- Gancio appendiabiti piccolo
- Small cloth hook
- Patère petite
- Percha pequeña



ART.	A	B
4CN.488.000D .xx	Ø 55	40*

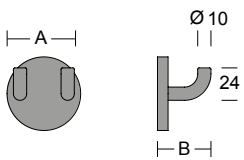

■ Polyamide 6

- Gancio appendiabiti doppio
- Double cloth hook
- Patère double
- Percha doble

THESE PRODUCTS CONTRIBUTE TO LEED® CREDITS

.XX FINISH



ART.	A	B
5CN.562.0000 .xx	Ø 53	75*

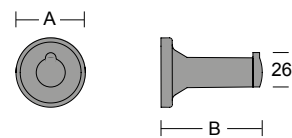

■ Polyamide 6

- Appendiabiti fermaporta
- Door-stop cloth hook
- Patère-butoir
- Tope-percha



ART.
4CA.0RC.0000.00

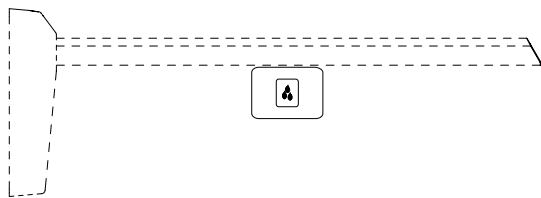

- Radiocomando per sistema elettronico di suono di emergenza e/o scarico dell'acqua WC
- Remote control for automatic WC-flushing system and/or emergency call
- Radiocommande pour système électronique d'évacuation de l'eau du WC et/ou appel d'urgence
- Control remoto electrónico para llamada de emergencia y/o la descarga de agua del WC



ART.
4CA.0RC.002C.00

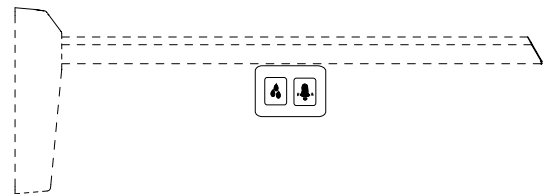

- Radiocomando per sistema elettronico di suono di emergenza e scarico dell'acqua WC
- Remote control for automatic WC-flushing system and emergency call
- Radiocommande pour système électronique d'évacuation de l'eau du WC et appel d'urgence
- Control remoto electrónico para llamada de emergencia y la descarga de agua del WC



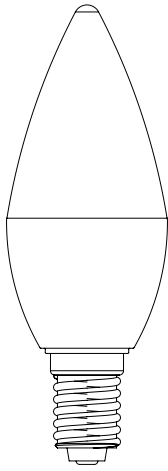

ART.
4CN.407.00LT.00

- Lampadina LED di classe energetica A+
- Light LED bulb energy class A+
- Ampoule LED de classe énergétique A+
- Bombilla LED de eficiencia energética A+

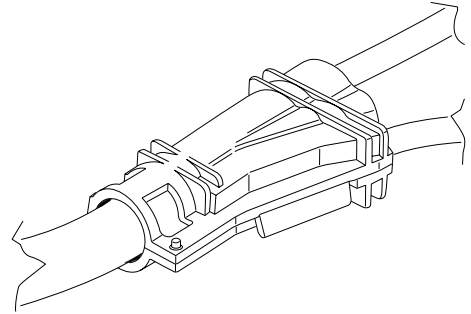

ART.
4CN.0IP.0068.00

- Giunzione rapida per cavi elettrici
- Quick junction for electric cables
- Jonction rapide pour cables électriques
- Kit conector para cables eléctricos

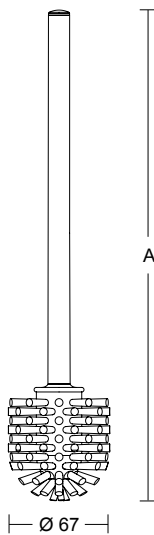

ART. A
4CA.486.00SR .xx 380*

- Scopino di riserva con impugnatura
- Spare toilet brush with handle
- Brosse WC de réserve avec manche
- Escobilla de reserva con mango

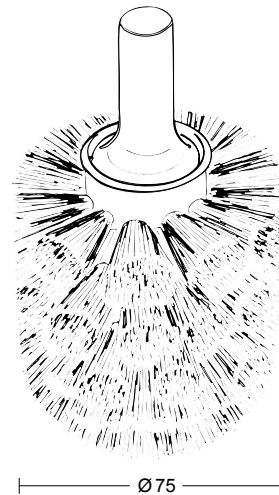

ART.
4CA.486.000B.00

- Scopino di riserva per art. 4CN.486.000C
- Spare toilet brush head for art. 4CN.486.000C
- Tête brosse WC de réserve pour art. 4CN.486.000C
- Cabezal de escobilla de reserva para escobillero para art. 4CN.486.000C

THESE PRODUCTS CONTRIBUTE TO LEED® CREDITS

.XX FINISH



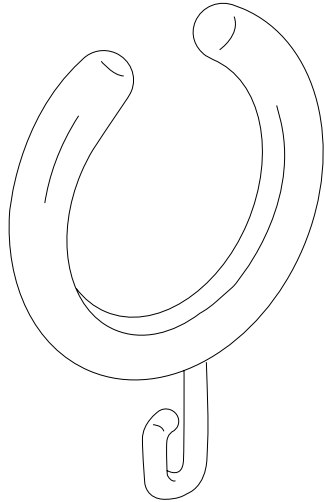

ART.
4CN.0AN.0002 .xx

- Anello reggitenda
- Shower curtain ring
- Anneau pour rideau de douche
- Anillas para cortina

THESE PRODUCTS CONTRIBUTE TO LEED® CREDITS

PROGRAMMA PBA WF

PATENT PENDING ITALY 102019000013932
PATENT DEUTCHLAND 202020104488.5

P B A
P A T E N T E D
S Y S T E M

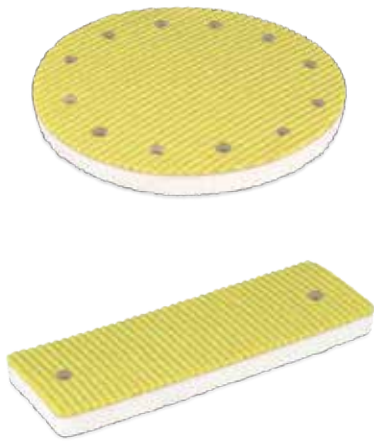

ART.
4CN.0VM.WF40.00

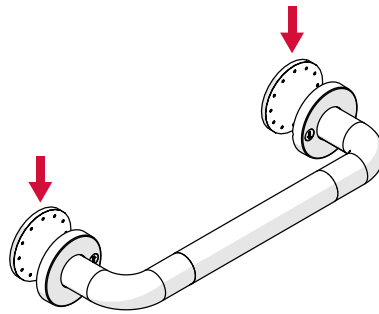

Articles with fixing rose



ART.
4CN.0VM.WF41.00

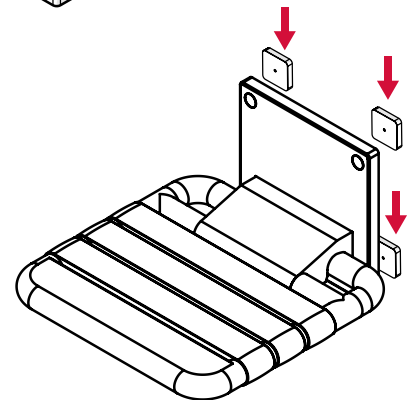

Shower seat with plate and lift-up support



ART.
4CN.0VM.WF47.00

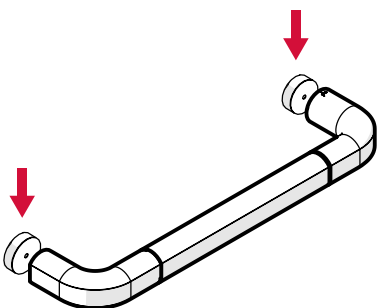

Safety support CAP and ART

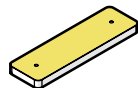

ART.
4CN.0VM.WF48.00

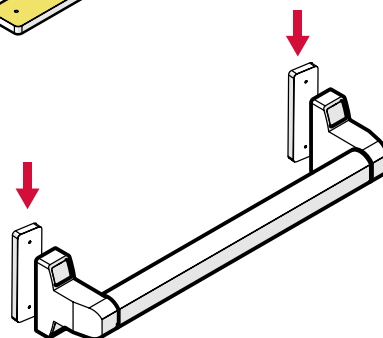

Safety support and accessories 400-ALU

PROGRAMMA CAP





ALLUMINIO EN-AW 6060 - ALUMINUM ALLOY EN-AW 6060 - ALUMINIUM EN-AW 6060 - ALUMINIO EN-AW 6060

LA LEGA DI ALLUMINIO EN-AW 6060 È UNA LEGA A MEDIA RESISTENZA, HA UN'OTTIMA RESISTENZA ALLA CORROSIONE, OTTIMA SALDABILITÀ E BUONA RESISTENZA ALLE BASSE TEMPERATURE. È COMUNEMENTE USATA PER REALIZZARE ELEMENTI ANCHE CON FORMA COMPLESSA E RISULTA MOLTO BUONA NEI PROCESSI DI ANODIZZAZIONE.

THE ALUMINUM EN-AW 6060 ALLOY HAS AN EXCELLENT RESISTANCE TO CORROSION, TO LOW TEMPERATURES AND ALLOWS QUALITY WELDINGS. IN THE DESIGN WORLD IT IS COMMONLY USED TO CREATE COMPONENTS WITH COMPLEX SHAPES ALLOWING EXCELLENT QUALITY RESULTS COMPARED TO OTHER ALLOYS FOR ANODIZING TREATMENTS.

L'ALLIAGE D'ALUMINIUM EN-AW 6060 EST UN ALLIAGE POUVANT ÊTRE TRAITÉ THERMIQUEMENT DE RÉSISTANCE MOYENNE. IL PRÉSENTE UNE TRÈS BONNE RÉSISTANCE À LA CORROSION, UNE TRÈS BONNE SOUDABILITÉ ET UNE BONNE FORMABILITÉ À FROID. IL EST COURAMMENT UTILISÉ POUR LES SECTIONS COMPLEXES ET PRÉSENTE UNE TRÈS BONNE RÉPONSE AU PROCESSUS D'ANODISATION.

LA ALEACIÓN DE ALUMINIO EN-AW 6060 ES UNA ALEACIÓN QUE SE PUEDE TRATAR CON CALOR DE RESISTENCIA MEDIA. TIENE MUY BUENA RESISTENCIA A LA CORROSIÓN, MUY BUENA SOLDABILIDAD Y BUENA CONFORMABILIDAD EN FRÍO. SE USA COMÚNMENTE PARA CORTES TRANSVERSALES COMPLEJOS Y TIENE UNA RESPUESTA DE ANODIZACIÓN MUY BUENA.

STANDARD

.30
BIANCO
WHITE
BLANC
BLANCO

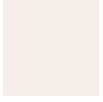

RAIL
 Coated aluminum
ACCESSORIES
 Coated aluminum
SUPPORT AND BENDS
 Coated aluminum

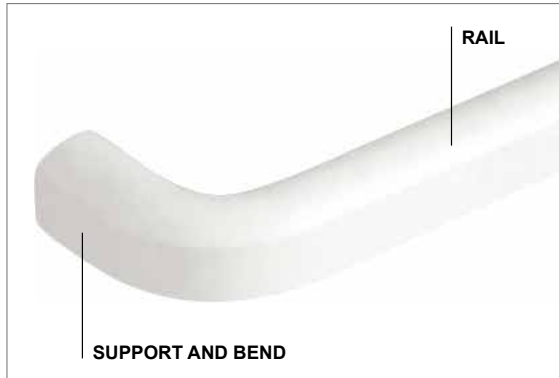

.24
GRIGIO CHIARO
LIGHT GREY
GRIS CLAIR
GRIS CLARO



RAIL
 Coated aluminum
ACCESSORIES
 Coated aluminum
SUPPORT AND BENDS
 Coated aluminum

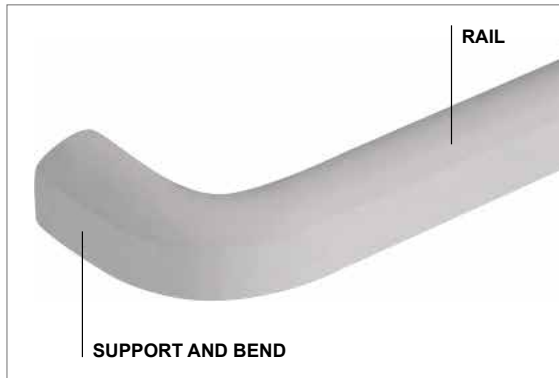

UPON REQUEST - ON MINIMUM LOT TO BE AGREED

.40
NERO
BLACK
NOIR
NEGRO



RAIL
 Coated aluminum
ACCESSORIES
 Coated aluminum
SUPPORT AND BENDS
 Coated aluminum

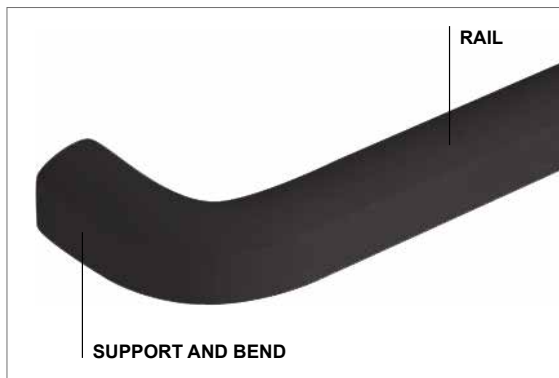

pba PER LA CERTIFICAZIONE LEED®

LEED® (LEADERSHIP IN ENERGY ENVIRONMENTAL DESIGN) È UN SISTEMA DI CERTIFICAZIONE A BASE VOLONTARIA PER LA GESTIONE, LA PROGETTAZIONE E LA COSTRUZIONE DI EDIFICI SOSTENIBILI DAL PUNTO DI VISTA SOCIALE, AMBIENTALE, ECONOMICO E DEL BENESSERE PER GLI UTILIZZATORI.



I PRODOTTI pba CONTRIBUISCONO AI PREREQUISITI E AI CREDITI LEED®.

PROCESSO INTEGRATO	IP	
MATERIALI E RISORSE	MR	
QUALITÀ DELL'AMBIENTE INTERNO	EQ	
INNOVAZIONE	I	

pba FOR LEED® CERTIFICATION

LEED® (LEADERSHIP IN ENERGY ENVIRONMENTAL DESIGN) IS A VOLUNTARY CERTIFICATION SYSTEM FOR THE MANAGEMENT, DESIGN AND CONSTRUCTION OF BUILDINGS THAT ARE SUSTAINABLE FROM A SOCIAL, ENVIRONMENTAL AND ECONOMIC POINT OF VIEW AND IN TERMS OF THE WELLBEING OF THE USERS.



pba PRODUCTS CONTRIBUTE TOWARD SATISFYING PREREQUISITES AND CREDITS UNDER LEED®.

INTEGRATED PROCESS	IP	
MATERIALS AND RESOURCES	MR	
INDOOR ENVIRONMENTAL QUALITY	EQ	
INNOVATION	I	

pba POUR LA CERTIFICATION LEED®

LEED® (LEADERSHIP IN ENERGY ENVIRONMENTAL DESIGN) EST UN SYSTÈME DE CERTIFICATION À BASE VOLONTAIRE POUR LA GESTION, LA CONCEPTION ET LA CONSTRUCTION DE BÂTIMENTS DURABLES D'UN POINT DE VUE SOCIAL, ENVIRONNEMENTAL, ÉCONOMIQUE ET DU BIEN-ÊTRE POUR LES UTILISATEURS.

LES PRODUITS pba CONTRIBUENT AUX CONDITIONS PRÉALABLES REQUISES ET AUX CRÉDITS LEED®.

PROCESSUS DE CONCEPTION INTÉGRÉE	IP	
MATÉRIAUX ET RESSOURCES	MR	
QUALITÉ DES ENVIRONNEMENTS INTÉRIEURS	EQ	
INNOVATION	I	

pba PARA LA CERTIFICACIÓN LEED®

LEED® (LEADERSHIP IN ENERGY ENVIRONMENTAL DESIGN) ES UN SISTEMA DE CERTIFICACIÓN DE BASE VOLUNTARIA PARA LA GESTIÓN, EL DISEÑO Y LA CONSTRUCCIÓN DE EDIFICIOS SOSTENIBLES DESDE EL PUNTO DE VISTA SOCIAL, MEDIOAMBIENTAL, ECONÓMICO Y DEL BIENESTAR PARA LOS USUARIOS.

LOS PRODUCTOS pba CONTRIBUYEN EN LOS PRE-REQUISITOS Y EN LOS CRÉDITOS LEED®.





PROCESO INTEGRADO	IP	
MATERIALES Y RECURSOS	MR	
CALIDAD DEL AMBIENTE INTERNO	EQ	
INNOVACIÓN	I	

CHART OF PBA PRODUCTS CONTRIBUTION TO LEED V4

INTEGRATIVE PROCESS

IP PREREQUISITE INTEGRATIVE PROCESS PLANNING AND DESIGN

MATERIALS AND RESOURCES

MR PREREQUISITE CONSTRUCTION AND DEMOLITION WASTE MANAGEMENT PLANNING

MR CREDIT CONSTRUCTION AND DEMOLITION WASTE MANAGEMENT

MR CREDIT BUILDING PRODUCT DISCLOSURE AND OPTIMIZATION - SOURCING OF RAW MATERIALS
 → OPTION 2 LEADERSHIP EXTRACTION PRACTICES

MR CREDIT BUILDING PRODUCT DISCLOSURE AND OPTIMIZATION - MATERIAL INGREDIENTS
 → OPTION 2 MATERIAL INGREDIENT OPTIMIZATION

INDOOR ENVIRONMENTAL QUALITY

EQ CREDIT LOW EMITTING MATERIALS

EQ CREDIT CONSTRUCTION AIR QUALITY MANAGEMENT PLAN

INNOVATION

IN PILOT CREDIT  DESIGN FOR FLEXIBILITY

IN PILOT CREDIT  SOCIAL EQUITY

IN PILOT CREDIT  INCLUSIVE DESIGN

IN CREDIT  DESIGN FOR DECONSTRUCTION

SOSTEGNI DI SICUREZZA
SAFETY SUPPORTS
BARRES D'APPUI
ASIDEROS

Page 162



AUSILI DI SICUREZZA RIBALTABILI
LIFT-UP SAFETY SUPPORTS
BARRES D'APPUI RELEVABLES
ASIDEROS ABATIBLES

Page 170

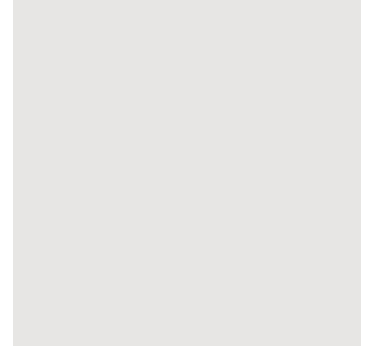

SEGGIOLINI
SEATS
SIÈGES
ASIENTOS

Page 172

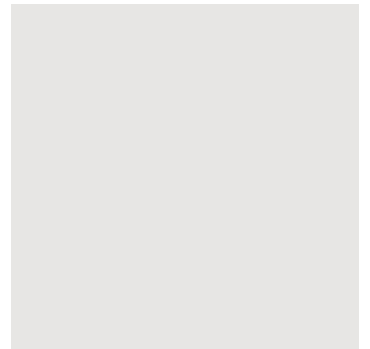
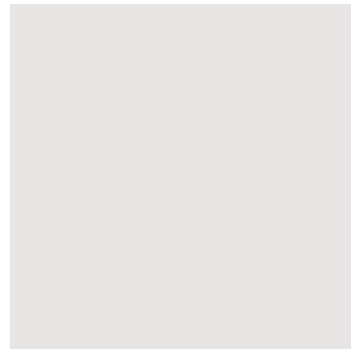

ACCESSORI BAGNO
BATHROOM ACCESSORIES
ACCESSOIRES DE BAIN
ACCESORIOS DE BAÑO

Page 174



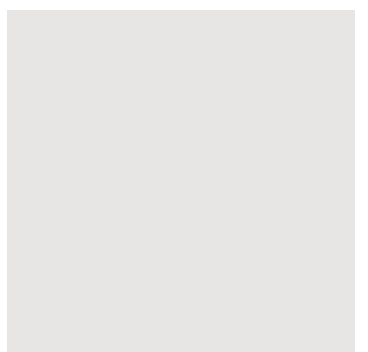
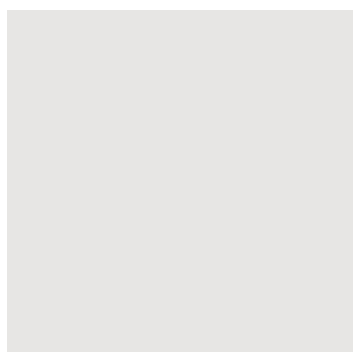
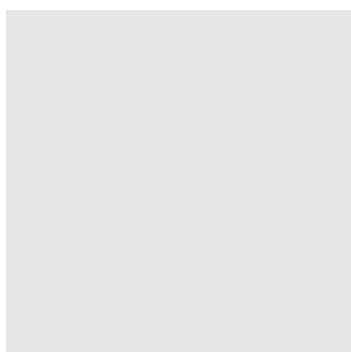
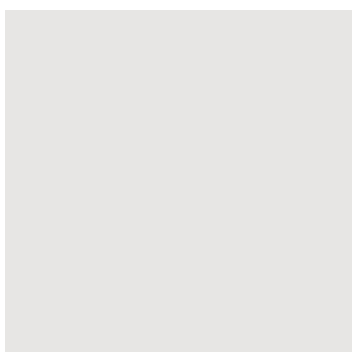
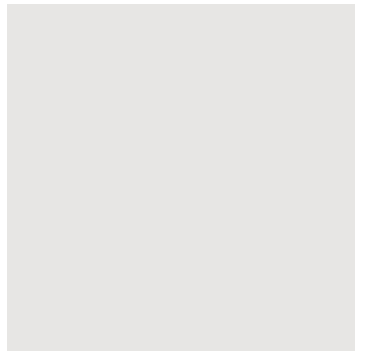
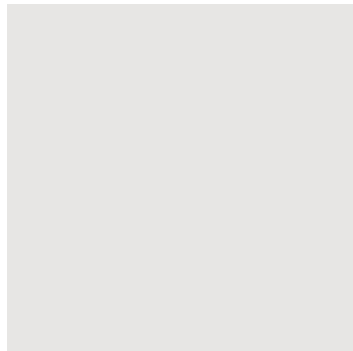
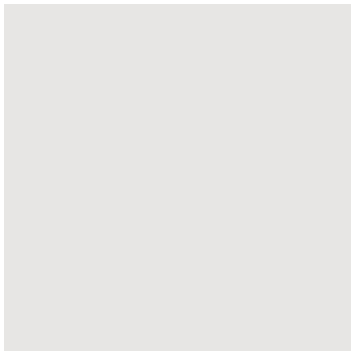
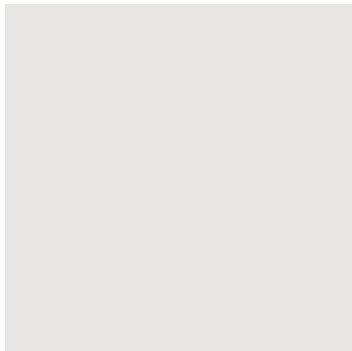
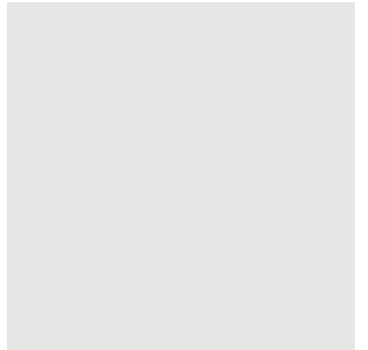
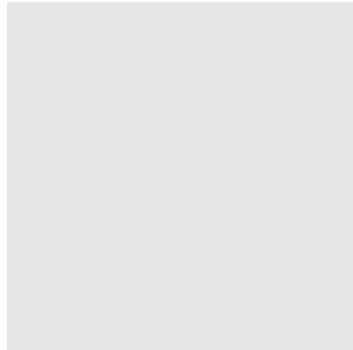
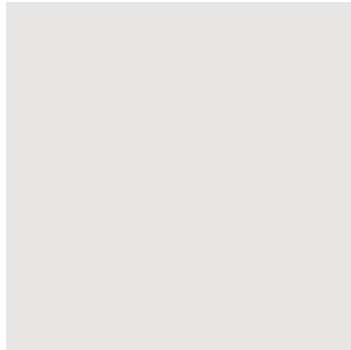
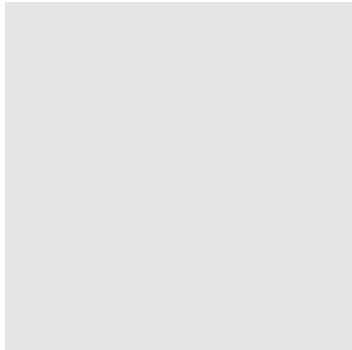
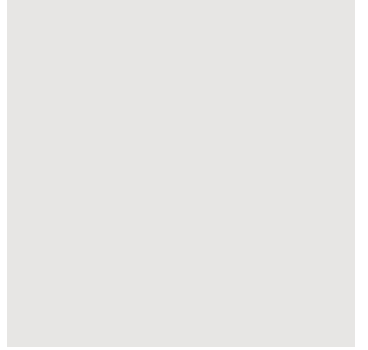
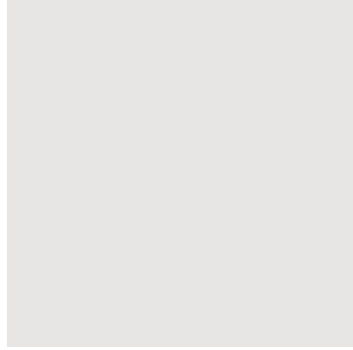
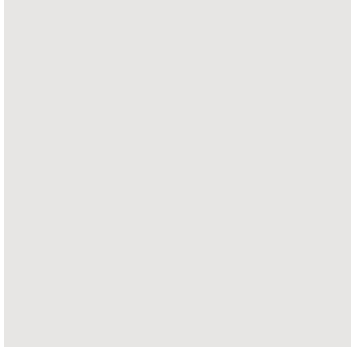
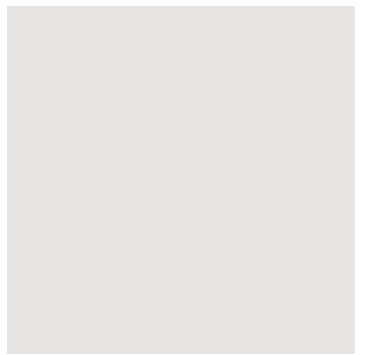
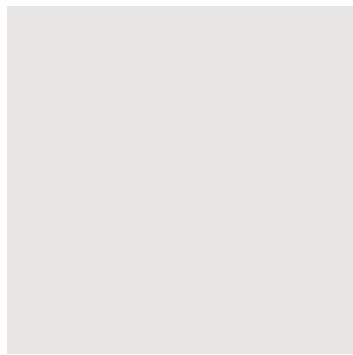
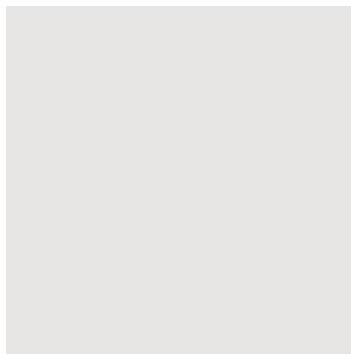
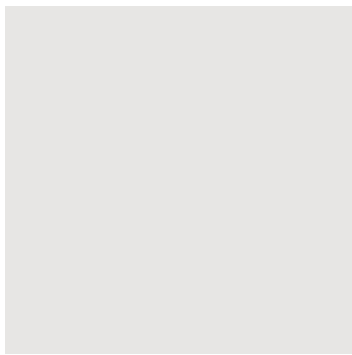





◆ RIGHT

ART.	◆	A	B
CAP.422.0000 .xx .x		220 (252)*	520 (552)*
CAP.22J.0000 .xx .x			
CAP.422.000M .xx .x		300 (332)*	520 (552)*
CAP.22J.000M .xx .x			
CAP.422.000L .xx .x		320 (352)*	720 (752)*
CAP.22J.000L .xx .x			
CAP.422.00LA .xx .x		400 (432)*	1160 (1192)*
CAP.22J.00LA .xx .x			
CAP.422.9999 .xx .x	Ⓢ		Ⓢ
CAP.22J.9999 .xx .x			

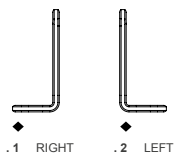
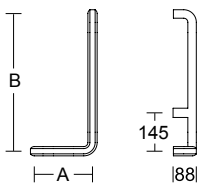

- Sostegno di sicurezza a "L"
- "L"-shaped safety support
- Barre d'appui forme à "L"
- Asidero en "L"



THESE PRODUCTS CONTRIBUTE TO LEED® CREDITS

.XX FINISH

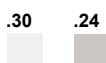

ART.	A	B
CAP.433.0000 .xx	1570 (1600)*	820 (852)*
CAP.33J.0000 .xx		
CAP.433.9999 .xx	Ⓢ	Ⓢ
CAP.33J.9999 .xx		

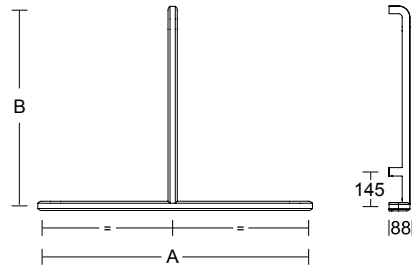

- Sostegno di sicurezza a "T"
- "T"-shaped safety support
- Barre d'appui forme à "T"
- Asidero en "T"



- ◆
- .1 DESTRO RIGHT DROITE DERECHA
- .2 SINISTRO LEFT GAUCHE IZQUIERDA



ART.	◆	A	B	C
CAP.424.0000 .xx.x		660 (676)*	660 (678)*	820 (852)*
☞ CAP.24J.0000 .xx.x				
CAP.424.000L .xx.x		760 (776)*	400 (418)*	1160 (1192)*
☞ CAP.24J.000L .xx.x				
CAP.424.00LA .xx.x		760 (776)*	760 (778)*	1160 (1192)*
☞ CAP.24J.00LA .xx.x				
CAP.424.9999 .xx.x	Ⓢ			
☞ CAP.24J.9999 .xx.x				

ART.	◆	A	B	C
CAP.443.000B .xx.x		760 (776)*	760 (776)*	1160 (1192)*
☞ CAP.43J.000B .xx.x				
CAP.443.00BL .xx.x		760 (776)*	1184 (1200)*	1160 (1192)*
☞ CAP.43J.00BL .xx.x				
CAP.443.999B .xx.x	Ⓢ			
☞ CAP.43J.999B .xx.x				

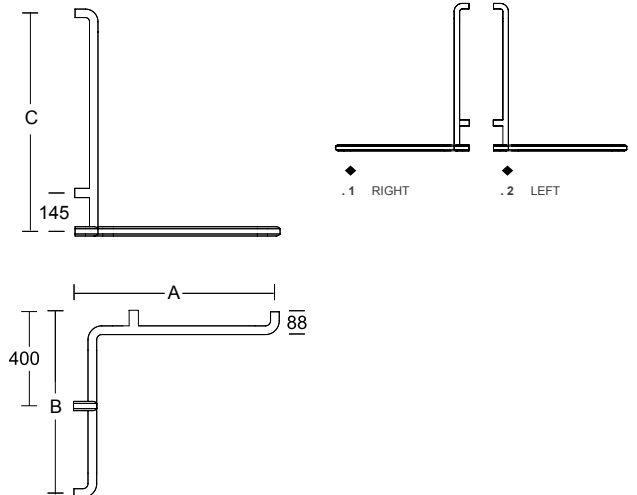
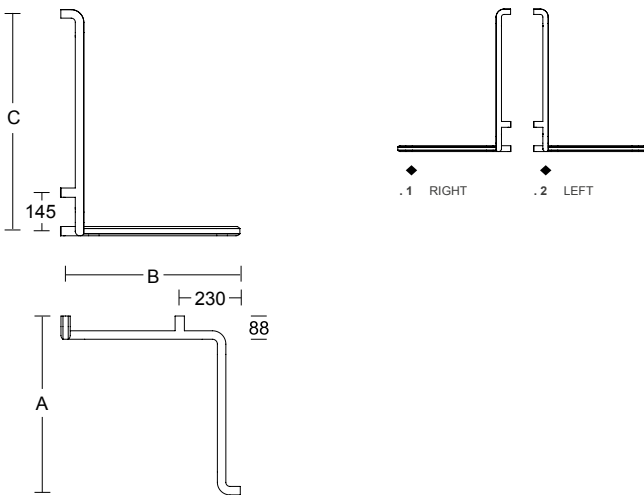

- Sostegno di sicurezza ad angolo con impugnatura verticale
- Corner shower rail with shower head rail
- Barre d'appui à coin avec barre de douche
- Asidero en ángulo con empuñadura vertical



- Sostegno di sicurezza ad angolo con impugnatura verticale
- Corner shower rail with shower head rail
- Barre d'appui à coin avec barre de douche
- Asidero en ángulo con empuñadura vertical



THESE PRODUCTS CONTRIBUTE TO LEED® CREDITS

.XX FINISH

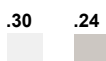

◆
 .1 DESTRO RIGHT DROITE DERECHA
 .2 SINISTRO LEFT GAUCHE IZQUIERDA



ART.	A
CAP.487.0000 .xx	570 (600)*
CAP.487.000A .xx	770 (800)*
CAP.487.000B .xx	970 (1000)*
CAP.487.000C .xx	1170 (1200)*
CAP.487.9999 .xx	

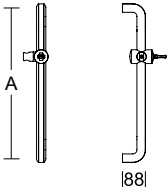

- Sostegno di sicurezza con reggisoffione
- Fixed safety support with shower head holder
- Barre d'appui fixe avec curseur de douche
- Asidero con soporte para ducha regulable en altura



THESE PRODUCTS CONTRIBUTE TO LEED® CREDITS

.XX FINISH

.30

.24



ART.	A	B
CAP.487.00RD .xx	140*	93*

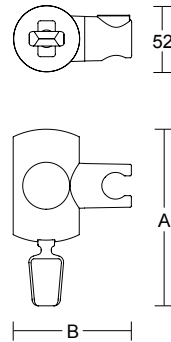

- Reggisoffione girevole con attacco conico universale a scorrimento compatibile con sostegni di sicurezza del PROGRAMMA CAP
- Rotating Shower head holder with universal sliding tapered connection compatible with all safety supports of the PROGRAMMA CAP
- Curseur de douche rabatable avec élément de fixation mobile et conique universel compatible avec les barres d'appui du PROGRAMMA CAP
- Soporte ducha giratorio con base cónica universal deslizable compatible con todos los asideros del PROGRAMA CAP



ART.	A
CAP.438.000B .xx .x	1860 (1875)*

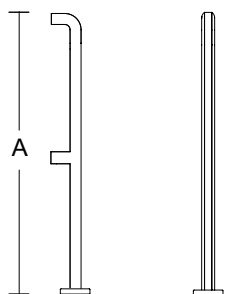

- Sostegno di sicurezza verticale (parete-pavimento) con supporto intermedio
- Vertical safety support (floor-to-wall) with intermediate wall support
- Barre d'appui verticale (mur-sol) avec support intermédiaire
- Asidero vertical (pared-suelo) con soporte intermedio



THESE PRODUCTS CONTRIBUTE TO LEED® CREDITS

.XX FINISH

.30

.24

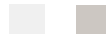

ART.	A
CAP.440.0000 .xx	370 (400)*
CAP.440.000A .xx	570 (600)*
CAP.440.000B .xx	770 (800)*
CAP.440.000C .xx	970 (1000)*
CAP.440.000Z .xx	300 (330)*
CAP.440.9999 .xx	

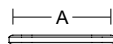

- Sostegno di sicurezza orizzontale
- Horizontal safety support
- Barre d'appui horizontale
- Asidero horizontal





ART.	A
CAP.423.000B .xx	1370 (1400)*
CAP.423.00BL .xx	1570 (1600)*
CAP.423.999B .xx	

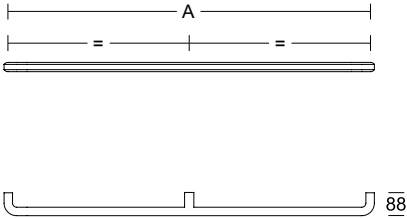

- Sostegno di sicurezza orizzontale con supporto intermedio
- Horizontal safety support with intermediate wall support
- Barre d'appui horizontale avec support intermédiaire
- Asidero horizontal con soporte intermedio



THESE PRODUCTS CONTRIBUTE TO LEED® CREDITS

.XX FINISH	.30	.24



◆ RIGHT

ART.	◆	A
CAP.442.0000 .xx .x		760 (776)*
CAP.442.000M .xx .x		960 (976)*
CAP.442.000L .xx .x		1160 (1176)*
CAP.442.9999 .xx .x		

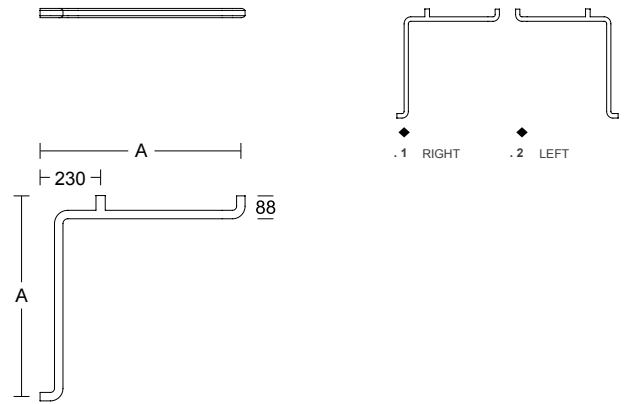

- Sostegno di sicurezza ad angolo simmetrico
- Symmetric corner safety shower rail
- Barre d'appui à coin symétrique
- Asidero en ángulo simétrico



- ◆
- .1 DESTRO RIGHT DROITE DERECHA
- .2 SINISTRO LEFT GAUCHE IZQUIERDA



ART.	◆	A	B
CAP.427.0000 .xx . x		500 (515)*	300 (315)*
CAP.427.9999 .xx . x	Ⓒ	Ⓒ	Ⓒ



- Sostegno di sicurezza fisso aperto
- Open fixed safety support
- Barre d'appui fixe coudée
- Asidero fijo en ángulo



THESE PRODUCTS CONTRIBUTE TO LEED® CREDITS

.XX FINISH	.30	.24



ART.	A
CAP.441.000P . xx	600*
CAP.441.00PL . xx	700*
CAP.441.0PLL . xx	850*

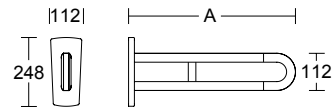

- Sostegno di sicurezza fisso su piastra
- Safety support fixed on plate
- Barre d'appui fixe sur plaque
- Asidero fijo sobre placa



- ◆
- .1 DESTRO RIGHT DROITE DERECHA
- .2 SINISTRO LEFT GAUCHE IZQUIERDA

.XX FINISH

.30

.24







P B A
PATENTED
DESIGN

PATENT
000873724 - 0002



ART.	A	B
CAP.445.000T .xx	600*	852*
CAP.445.0000 .xx	700*	952*
CAP.445.000L .xx	850*	1102*

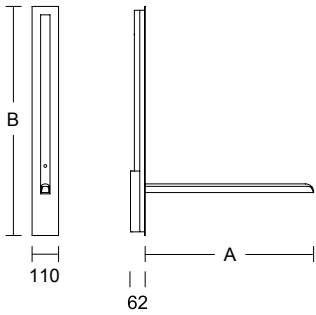

- Sostegno di sicurezza ribaltabile a scomparsa
- Lift-up foldaway safety support
- Barre d'appui relevable escamotable
- Asidero abatible retráctil



THESE PRODUCTS CONTRIBUTE TO LEED® CREDITS

.XX FINISH

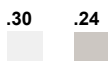

P B A
PATENTED
DESIGN

PATENT
IT 0000101043

ART.	A
4CA.445.000T .xx	600*
4CA.45Y.000T .xx	
4CA.45K.000T .xx	
4CA.445.0000 .xx	700*
4CA.45Y.0000 .xx	
4CA.45K.0000 .xx	
4CA.445.000L .xx	850*
4CA.45Y.000L .xx	
4CA.45K.000L .xx	

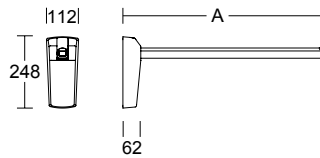

- Sostegno di sicurezza ribaltabile
- Lift-up safety support
- Barre d'appui relevable
- Asidero abatible







ART.	A	B	C	D
CAP.447.000B .xx	460*	340*	450*	390*

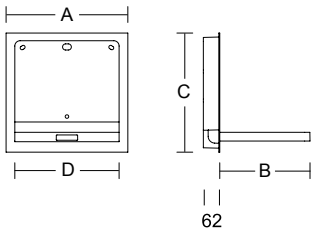

- Seggiolino ribaltabile a scomparsa
- Lift-up foldaway shower seat
- Siège relevable escamotable
- Asiento abatible retráctil



THESE PRODUCTS CONTRIBUTE TO LEED® CREDITS

.XX FINISH



.30

.24







ART.	A	
CAP.429.0000 .xx	800*	8
CAP.429.000A .xx	900*	9
CAP.429.000B .xx	1000*	10
CAP.429.000C .xx	1100*	11
CAP.429.000D .xx	1200*	12
CAP.429.000E .xx	1300*	13
CAP.429.9999 .xx		

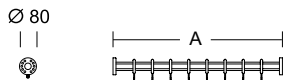



- Reggitenda dritto
- Straight shower curtain rail
- Barre de rideau de douche droit
- Barra de cortina de ducha recta

THESE PRODUCTS CONTRIBUTE TO LEED® CREDITS

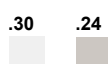
.XX FINISH





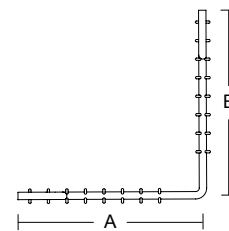
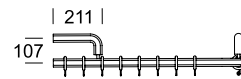

ART.	A	B	
CAP.436.0000 .xx	800 (815)*	800 (815)*	16
CAP.436.9999 .xx			



- Reggitenda angolare con due supporti a muro
- Corner shower curtain rail with two wall supports
- Barre de rideau de douche à coin avec deux supports murales
- Barra de cortina de ducha en ángulo con dos soportes en pared





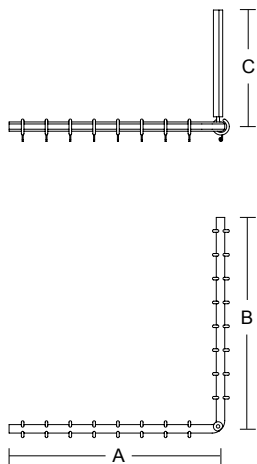

ART.	A	B	C	
CAP.436.000B .xx	800 (815)*	800 (815)*	440 (458)*	16
CAP.436.00BA .xx	900 (915)*	900 (915)*	440 (458)*	18
CAP.436.00BB .xx	1000 (1015)*	1000 (1015)*	440 (458)*	20
CAP.436.00BC .xx	1200 (1215)*	1200 (1215)*	440 (458)*	24
CAP.436.00BD .xx	1500 (1515)*	1500 (1515)*	440 (458)*	30
CAP.436.999B .xx				

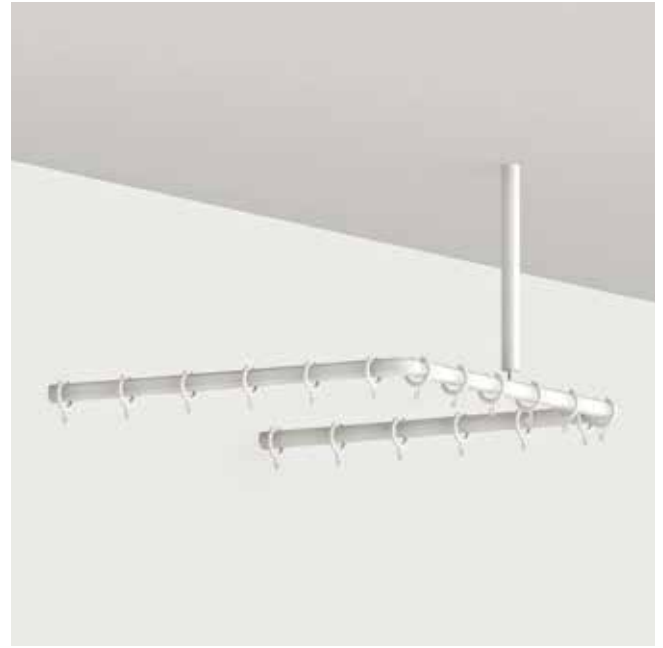

- Reggitenda angolare con supporto a soffitto
- Corner shower curtain rail with ceiling support
- Barre de rideau de douche à coin avec support plafond
- Barra de cortina de ducha en ángulo con soporte de techo



ART.	A	B	C	
CAP.437.0000 .xx	800 (815)*	800 (830)*	440 (458)*	24
CAP.437.000A .xx	1000 (1015)*	1000 (1030)*	440 (458)*	30
CAP.437.9999 .xx				

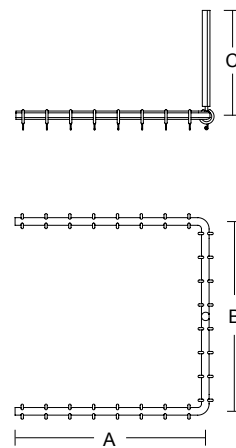

- Reggitenda su tre lati con supporto a soffitto
- Three-sided shower curtain rail with ceiling support
- Barre de rideau de douche sur trois côtés avec support plafond
- Barra de cortina de ducha en "U" con soporte de techo

THESE PRODUCTS CONTRIBUTE TO LEED® CREDITS

.XX FINISH

.30

.24





ART.	L	H	
4CN.0SC.000B.01	1200	2000	Art. CAP.429.0000 .xx
			CAP.429.000A .xx
			CAP.429.000B .xx
			CAP.436.0000 .xx*
			CAP.436.000B .xx*
			CAP.436.00BA .xx*
4CN.0SC.000C.01	1800	2000	Art. CAP.429.000C .xx
			CAP.429.000D .xx
			CAP.429.000E .xx
			CAP.436.00BC .xx*
			CAP.436.00BD .xx*
			CAP.437.0000 .xx*

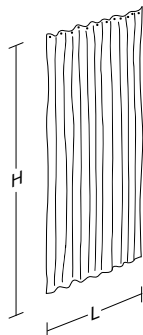

- Tenda ignifuga per doccia
- Fireproof shower curtain
- Rideau de douche ignifuge
- Cortina de ducha ignífuga

THESE PRODUCTS CONTRIBUTE TO LEED® CREDITS



ART.	L	H	
4CN.0SC.00BE.01	1200	2000	Art. CAP.429.0000 .xx
			CAP.429.000A .xx
4CN.0SC.00FE.01	1500	2000	Art. CAP.429.000B .xx
			CAP.429.000C .xx
			CAP.436.00BC .xx*
			CAP.437.0000 .xx*
4CN.0SC.00CE.01	1800	2000	Art. CAP.429.000D .xx
			CAP.429.000E .xx
			CAP.436.00BD .xx*
			CAP.437.000A .xx*
4CN.0SC.00DE.01	2000	2000	Art. CAP.436.0000 .xx
			CAP.436.000B .xx
4CN.0SC.00EE.01	2400	2000	Art. CAP.436.00BA .xx
			CAP.436.00BB .xx

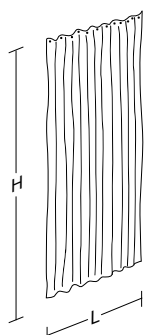

- Tenda impermeabile per doccia
- Waterproof shower curtain
- Rideau de douche imperméable
- Cortina de ducha impermeable



ART.	A	B
CAP.490.0000 .xx	600*	1100*

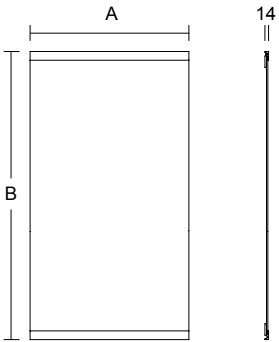

- Specchio fisso
- Fixed mirror
- Miroir fixe
- Espejo fijo



ART.	A	B	C
CAP.490.00QR .xx	600*	700*	15

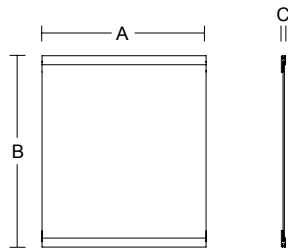

- Specchio fisso con cornice
- Fixed mirror with frame
- Miroir fixe avec cadre
- Espejo fijo con marco

THESE PRODUCTS CONTRIBUTE TO LEED® CREDITS

.XX FINISH

.30

.24





ART.	A	B	C	α
CAP.470.0000 .xx	600*	530*	150*	14°

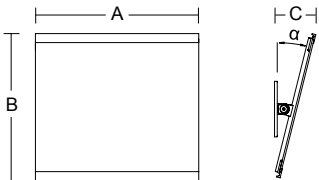

- Specchio orientabile
- Adjustable mirror
- Miroir orientable
- Espejo orientable

THESE PRODUCTS CONTRIBUTE TO LEED® CREDITS

.XX FINISH

.30

.24





ART.	A	B
CAP.407.0TUA .xx	405*	61*

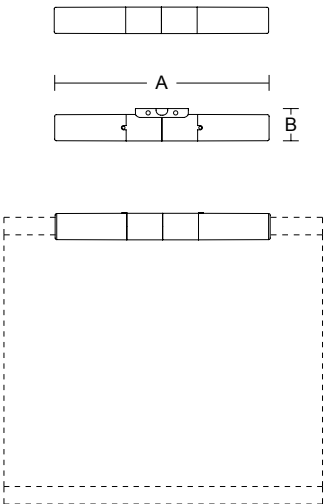

- Lampada da applicare su specchi con cornice.
IP 54 con Art. 4CN.0IP.0068.00
- Lamp for mirrors with frame.
IP 54 with Art. 4CN.0IP.0068.00
- Lampe pour miroirs avec cadre
. IP 54 avec Art. 4CN.0IP.0068.00
- Aplique para espejos con marco
IP 54 con Art. 4CN.0IP.0068.00

CE
IP 54

THESE PRODUCTS CONTRIBUTE TO LEED® CREDITS

.XX FINISH

.30

.24



ART.	A	B
CAP.407.0TUR .xx	405*	75*

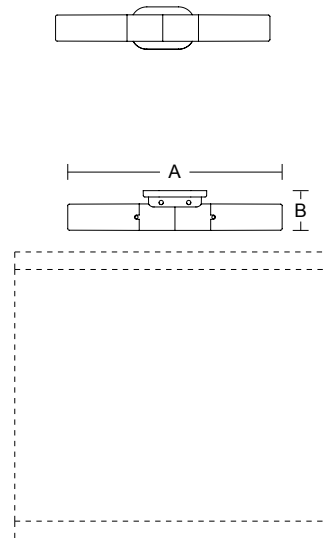

- Lampada da fissare a parete.
IP 54 con Art. 4CN.0IP.0068.00
- Wall lamp for mirror.
IP 54 with Art. 4CN.0IP.0068.00
- Lampe de mur pour miroir.
IP 54 avec Art. 4CN.0IP.0068.00
- Aplique con fijación en pared
IP 54 con Art. 4CN.0IP.0068.00

CE
IP 54



ART.	A	B	C
CAP.483.00PM .xx	150*	110*	44*

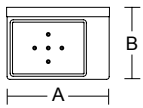
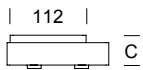

ART.	A	B	C
CAP.483.000P .xx	150*	92*	44*

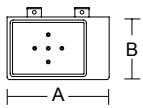
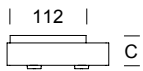

- Mensola con portasapone
- Shelf with soap dish
- Tablette avec porte savon
- Estante con jabonera



ART.	A	B	C
CAP.483.00DM .xx	150*	110*	136*

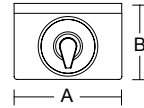
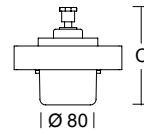

ART.	A	B	C
CAP.483.000D .xx	150*	92*	136*

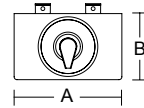
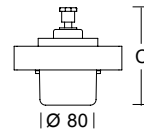

- Mensola con dispenser
- Shelf with soap dispenser
- Tablette avec distributeur de savon
- Estante con dispensador de jabón (lt 0,4)

THESE PRODUCTS CONTRIBUTE TO LEED® CREDITS

.XX FINISH

.30

.24





ART.	A	B
CAP.483.01BM .xx	150*	110*

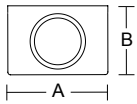
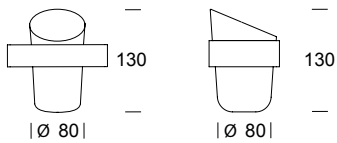

ART.	A	B
CAP.483.00IB .xx	150*	92*

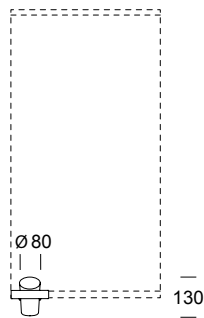
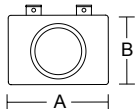
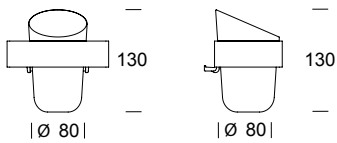

- Mensola con bicchiere conico
- Shelf with conical tumbler
- Tablette avec gobelet conique
- Estante con vaso cónico

THESE PRODUCTS CONTRIBUTE TO LEED® CREDITS

.XX FINISH

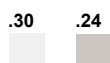

ART.	A	B	C
CAP.492.000B .xx	210*	105*	103*

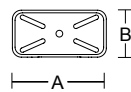

- Mensola applicabile su supporto orizzontale
- Shelf to be integrated to horizontal support
- Tablette accrochable à la barre d'appui horizontale
- Estante aplicable a asidero horizontal



ART.	A	B	C
CAP.004.0000.30	624	40	110

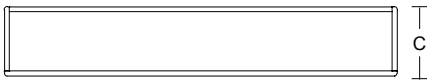
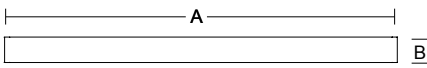

Combinazioni / combinations / combinaisons / combinaciones



CAP.004.0000.30 + CAP.006.0000.30



CAP.004.0000.30 + CAP.005.0000.30



CAP.004.0000.30 + CAP.008.0000.30



CAP.004.0000.30 + CAP.007.0000.30



CAP.004.0000.30

- Mensola per dispenser o bicchiere o vassoio o portasapone / Portasciugamani
- Bathroom shelf for soap dispenser or tumbler or tray or soap dish / towel holder
- Tablette pour doseur savon ou gobelet ou plateau ou porte-savon / porte-serviettes
- Estante para distribuidor o vaso o bandeja o jabonera / Toallero

THESE PRODUCTS CONTRIBUTE TO LEED® CREDITS

POWDER-COATED ALUMINIUM

FINISH .30



ART.	A	B	C
CAP.003.0000.30	161	40	110

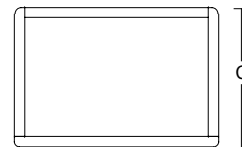
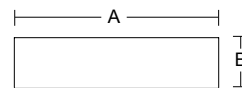

Combinazioni / combinations / combinaisons / combinaciones



CAP.003.0000.30 + CAP.006.0000.30



CAP.003.0000.30 + CAP.005.0000.30



CAP.003.0000.30 + CAP.007.0000.30

- Mensola per dispenser o bicchiere o portasapone
- Bathroom shelf for soap dispenser or tumbler or soap dish
- Tablette pour doseur savon ou gobelet ou porte-savon
- Estante para distribuidor o vaso o jabonera



ART.	A	B	C
CAP.005.0000.30	76	107	105

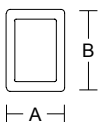
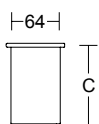

Combinazioni / combinations / combinaisons / combinaciones



CAP.005.0000.30 + CAP.004.0000.30



CAP.005.0000.30 + CAP.003.0000.30

- Bicchiere per mensola
- Tumbler for shelf
- Gobelet pour tablette
- Vaso para estante

THESE PRODUCTS CONTRIBUTE TO LEED® CREDITS

CERAMIC

FINISH .30



ART.	A	B	C
CAP.006.0000.30	76	107	170

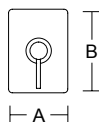
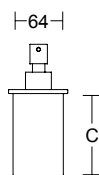

Combinazioni / combinations / combinaisons / combinaciones



CAP.006.0000.30 + CAP.004.0000.30



CAP.006.0000.30 + CAP.003.0000.30

- Dispenser per mensola
- Soap dispenser for shelf
- Doseur savon pour tablette
- Distribuidor jabón para estante



ART.	A	B	C
CAP.007.0000.30	154	107	30

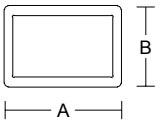
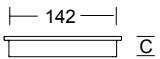

Combinazioni / combinations / combinaisons / combinaciones



CAP.007.0000.30 + CAP.004.0000.30



CAP.007.0000.30 + CAP.003.0000.30

- Portasapone per mensola
- Soap dish for bathroom shelf
- Porte-savon pour tablette
- Jabonera para estante

THESE PRODUCTS CONTRIBUTE TO LEED® CREDITS

CERAMIC

FINISH .30



ART.	A	B	C
CAP.008.0000.30	310	107	12

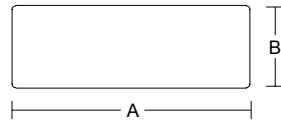
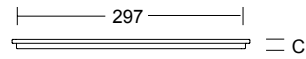

Combinazioni / combinations / combinaisons / combinaciones



CAP.008.0000.30 + CAP.004.0000.30

- Vassoio per mensola
- Tray for bathroom shelf
- Plateau pour tablette
- Bandeja para estante



ART.	A	B
CAP.010.0000.30	193	752

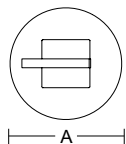
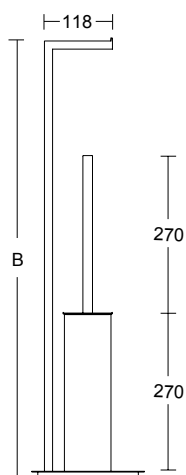

- Piantana porta rotolo e porta scopino
- Toilet paper and brush holder stand
- Support pour porte-papier et ensemble brosse WC
- Soporte de pie portarrotolo con escobillero



ART.	A	B	C
CAP.009.0000.30	260	260	325

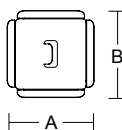
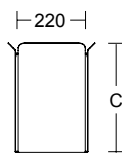

- Cestino
- Paper basket
- Poubelle
- Cubo de basura

THESE PRODUCTS CONTRIBUTE TO LEED® CREDITS

FINISH .30



ART.	A	B	C
CAP.486.0000 .xx	150*	110*	380*

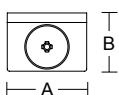
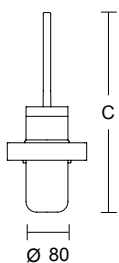

- Portascopino
- Toilet brush set
- Ensemble brosse WC
- Escobillero



ART.	A	B	C
CAP.481.00BA .xx	150*	110	108

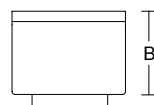
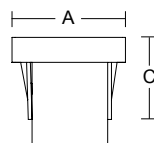

- Portarotolo a muro
- Wall toilet roll holder
- Porte-papier murale
- Portarrotolo de pared

THESE PRODUCTS CONTRIBUTE TO LEED® CREDITS

.XX FINISH

.30

.24





ART.	A	B	C
CAP.498.0000 .30	120	265*	320*

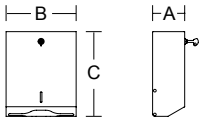

- Portasalviette verniciato bianco
 - White varnished paper towel dispenser
 - Distributeur d'essuie-mains papier en coloris laqué blanc
 - Dispensador de papel toallas pintado blanco
- Colore
 Colour
 Couleur
 Color

THESE PRODUCTS CONTRIBUTE TO LEED® CREDITS

FINISH **.30**

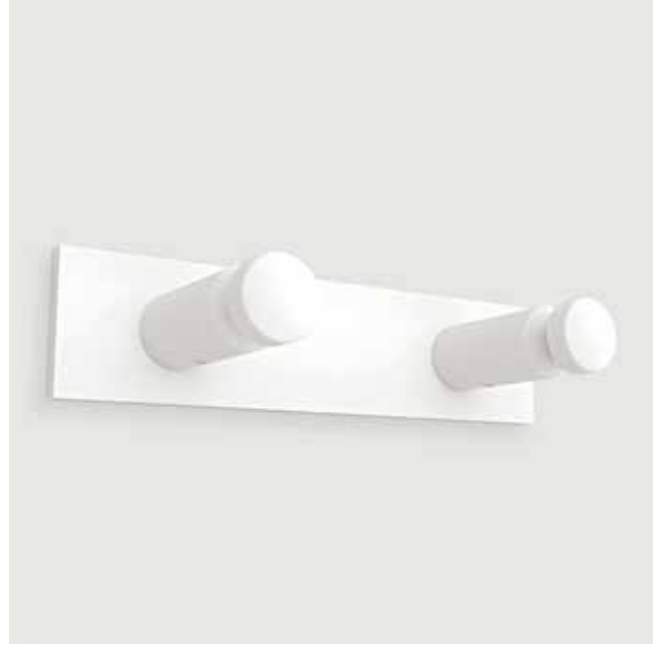
ART.	A	B
CAP.488.0000 .xx	125*	30*

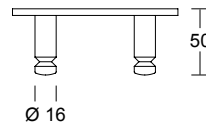
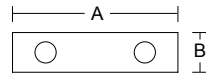

- Gancio appendiabiti doppio
- Double cloth hook
- Patère double
- Percha doble

.XX FINISH **.30** **.24**





ART.	A	B
CAP.562.0000 .xx	Ø 50	76*

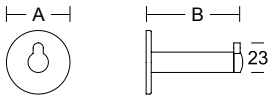

- Appendiabiti fermaporta
- Door-stop cloth hook
- Patère-butoir
- Tope-percha

THESE PRODUCTS CONTRIBUTE TO LEED® CREDITS

.XX FINISH

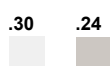

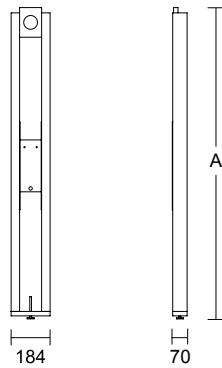

ART.	A	
CAP.445.CG01.00	1470	(I) (F)
CAP.445.CG02.00	1350	(GB)
CAP.445.CG03.00	1410	(D) (A)

- Telaio per applicare art. CAP.445.000T, CAP.445.0000 e CAP.445.000L nelle pareti in **cartongesso**
- Fixture on **plasterboard** walls for the application of articles CAP.445.000T, CAP.445.0000, CAP.445.000L
- Bâti à introduire dans les parois en **placoplâtre** pour l'application des articles CAP.445.000T, CAP.445.0000 et CAP.445.000L
- Bastidor que se inserta en las paredes de **cartón yeso** para aplicar los artículos CAP.445.000T, CAP.445.0000, CAP.445.000L

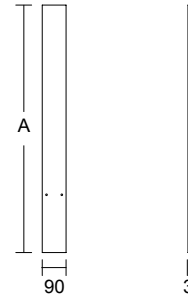

ART.	A
CAP.445.DM0T.00	835
CAP.445.DM00.00	935
CAP.445.DM0L.00	1085

- Dima per fori di alloggiamento art. CAP.445.000T (CAP.445.DM0T.00), CAP.445.0000 (CAP.445.DM00.00), CAP.445.000L (CAP.445.DM0L.00) nelle pareti in **cartongesso**
- Drill template for art. CAP.445.000T (CAP.445.DM0T.00), CAP.445.0000 (CAP.445.DM00.00) and CAP.445.000L (CAP.445.DM0L.00) for **plasterboard** walls
- Gabarit pour trous de fixation des articles CAP.445.000T (CAP.445.DM0T.00), CAP.445.0000 (CAP.445.DM00.00) et CAP.445.000L (CAP.445.DM0L.00) pour parois en **placoplâtre**
- Plantilla para orificios de alojamiento del art. CAP.445.000T (CAP.445.DM0T.00), CAP.445.0000 (CAP.445.DM00.00) y el CAP.445.000L (CAP.445.DM0L.00) en paredes de **cartón yeso**

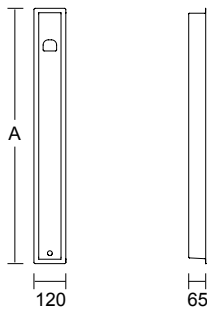

ART.	A
CAP.445.WP0T.00	865
CAP.445.WP00.00	965
CAP.445.WP0L.00	1085

- Protezione a tenuta stagna per art CAP.445.000T (CAP.445.WP0T.00), CAP.445.0000 (CAP.445.WP00.00), CAP.445.000L (CAP.445.WP0L.00)
- Watertight protection for art CAP.445.000T (CAP.445.WP0T.00), CAP.445.0000 (CAP.445.WP00.00), CAP.445.000L (CAP.445.WP0L.00)
- Protection étanche pour les articles CAP.445.000T (CAP.445.WP0T.00), CAP.445.0000 (CAP.445.WP00.00), CAP.445.000L (CAP.445.WP0L.00)
- Protección estanca para art CAP.445.000T (CAP.445.WP0T.00), CAP.445.0000 (CAP.445.WP00.00), CAP.445.000L (CAP.445.WP0L.00)

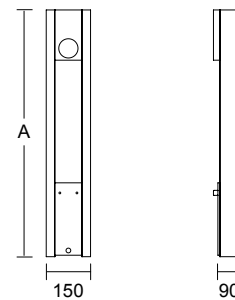

ART.	A
CAP.445.MR0T.00	835
CAP.445.MR00.00	935

- Telaio per applicare art. CAP.445.000T (CAP.445.MR0T.00), CAP.445.0000 e CAP.445.000L (CAP.445.MR00.00) nelle pareti in **muratura**
- Fixture to set in **brick** walls for the application of articles CAP.445.000T (CAP.445.MR0T.00), CAP.445.0000 and CAP.445.000L (CAP.445.MR00.00)
- Bâti à introduire dans les parois **maçonnées** pour l'application des articles CAP.445.000T (CAP.445.MR0T.00), CAP.445.0000 et CAP.445.000L (CAP.445.MR00.00)
- Bastidor que se empotra en las paredes de **mampostería** para aplicar los artículos CAP.445.000T (CAP.445.MR0T.00), CAP.445.0000 y CAP.445.000L (CAP.445.MR00.00)

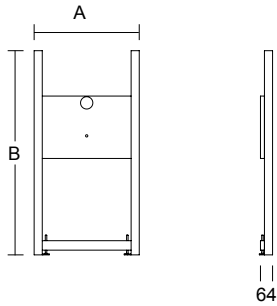

ART.	A	B
CAP.447.CG0B.00	556	1080

- Telaio per applicare art. CAP.447.000B nelle pareti in **cartongesso**
- Fixture on **plasterboard** walls for the application of article CAP.447.000B
- Bâti à introduire dans les parois en **placoplâtre** pour l'application de l'article CAP.447.000B
- Bastidor que se inserta en las paredes de **cartón yeso** para aplicar el artículo CAP.447.000B

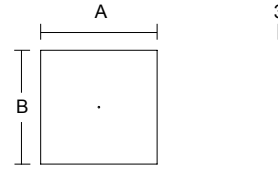

ART.	A	B
CAP.447.DM0B.00	440	430

- Dima per foro di alloggiamento art. CAP.447.000B nelle pareti in **cartongesso**
- Drill template for art. CAP.447.000B for **plasterboard** walls
- Gabarit pour trous de fixation de l'article CAP.447.000B pour parois en **placoplâtre**
- Plantilla para orificios de alojamiento del art. CAP.447.000B en paredes de **cartón yeso**

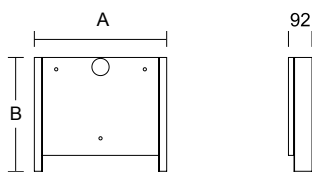

ART.	A	B
CAP.447.MR0B.00	500	430

- Telaio per applicare art. CAP.447.000B nelle pareti in **muratura**
- Fixture to set in **brick** walls for the application of article CAP.447.000B
- Bâti à introduire dans les parois **maçonnées** pour l'application de l'article CAP.447.000B
- Bastidor que se empotra en las paredes de **mampostería** para aplicar el artículo CAP.447.000B

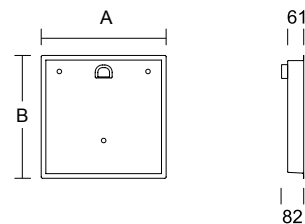

ART.	A	B
CAP.447.WP0B.00	472	465

- Protezione a tenuta stagna per art. CAP.447.000B
- Watertight protection for art. CAP.447.000B
- Protection étanche pour l' article CAP.447.000B
- Protección estanca para art CAP.447.000B

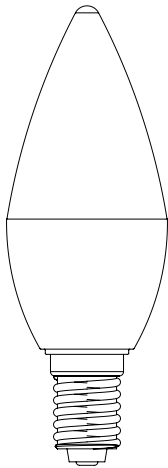

ART.
4CN.407.00LT.00

- Lampadina LED di classe energetica A+
- Light LED bulb energy class A+
- Ampoule LED de classe énergétique A+
- Bombilla LED de eficiencia energética A+

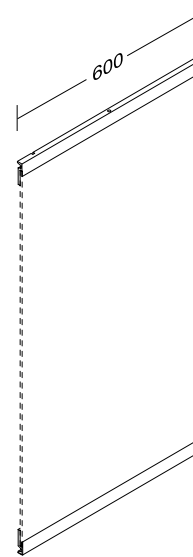

ART.
CAP.4PR.0000 .xx

- Profili reggispecchio
- Mirror profile
- Profils porte-miroir
- Perfiles de sujeción para espejos

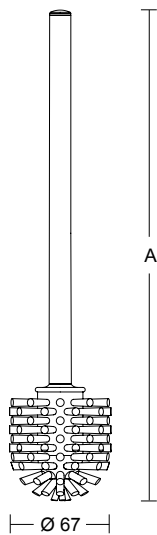

ART. A
4CA.486.00SR .xx 380*

- Scopino di riserva con impugnatura
- Spare toilet brush with handle
- Brosse WC de réserve avec manche
- Escobilla de reserva con mango

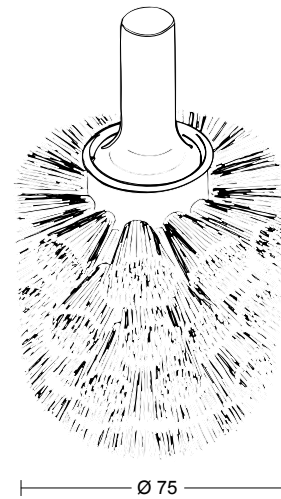

ART.
4CN.486.000B.00

- Scopino di riserva
- Spare toilet brush head
- Tête brosse WC de réserve
- Cabezal de escobilla de reserva para escobillero

THESE PRODUCTS CONTRIBUTE TO LEED® CREDITS

.XX FINISH

.30

.24



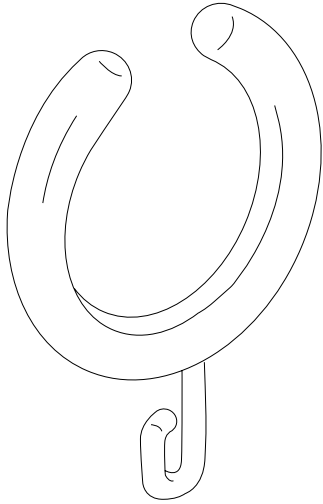

ART.
4CN.0AN.0002 .xx

- Anello reggitenda
- Shower curtain ring
- Anneau pour rideau de douche
- Anillas para cortina

THESE PRODUCTS CONTRIBUTE TO LEED® CREDITS

PROGRAMMA PBA WF

PATENT PENDING ITALY 102019000013932
PATENT DEUTCHLAND 202020104488.5

PBA
PATENTED
SYSTEM

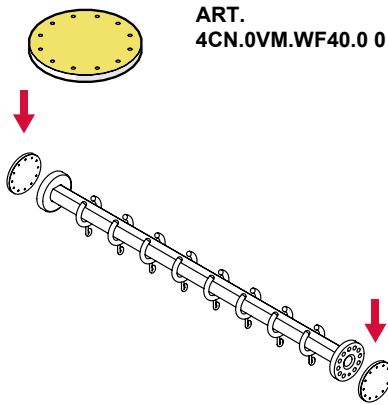
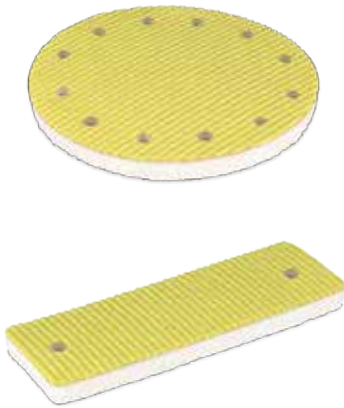

Articles with fixing rose

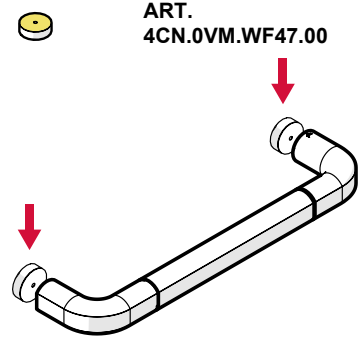

Safety support CAP and ART

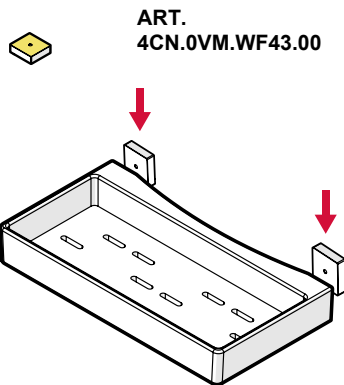

Bathroom shelf 400-NY and CAP





ALLUMINIO EN-AW 6060 - ALUMINUM ALLOY EN-AW 6060 - ALUMINIUM EN-AW 6060 - ALUMINIO EN-AW 6060

LA LEGA DI ALLUMINIO EN-AW 6060 HA UN'OTTIMA RESISTENZA ALLA CORROSIONE E PERMETTE LA REALIZZAZIONE DI OGGETTI SALDATI DI GRANDE QUALITÀ. NEL MONDO DEL DESIGN È UTILIZZATO PER REALIZZARE OGGETTI CON FORME COMPLESSE ED HA RISULTATI QUALITATIVI ECCELLENTI RISPETTO AD ALTRE LEGHE DI ALLUMINIO AI TRATTAMENTI DI ANODIZZAZIONE.

THE ALUMINUM 6060 ALLOY HAS AN EXCELLENT RESISTANCE TO CORROSION, TO LOW TEMPERATURES AND ALLOWS QUALITY WELDINGS. IN THE DESIGN WORLD IT IS COMMONLY USED TO CREATE COMPONENTS WITH COMPLEX SHAPES ALLOWING EXCELLENT QUALITY RESULTS COMPARED TO OTHER ALLOYS FOR ANODIZING TREATMENTS.

L'ALLIAGE D'ALUMINIUM EN-AW 6060 EST UN ALLIAGE AVEC UNE TRÈS BONNE RÉSISTANCE À LA CORROSION, IL PERMET DE RÉALISER OBJETS SOUDÉS DE GRANDE QUALITÉ. DANS LE DOMAIN DU DESIGN IL EST UTILISÉ POUR REALISER OBJETS AVEC FORME COMPLEXES ET OBTIENT DES RÉSULTATS DE QUALITÉ EXCELLENTS PAR RAPPORT AUX AUTRES ALLIAGE D'ALUMINIUM DANS LES PROCÈS D'ANODISATION.

LA ALEACIÓN DE ALUMINIO EN-AW 6060 CUENTA CON UNA MUY BUENA RESISTENCIA FRENTE A LA CORROSIÓN Y PERMITE REALIZAR OBJETOS SOLDADOS DE GRAN CALIDAD. EN EL MUNDO DEL DISEÑO SE UTILIZA PARA REALIZAR OBJETOS CON FORMAS COMPLEJAS Y PRESENTA MUY BUENOS RESULTADOS DE CALIDAD DEL ANODIZADO CON RESPECTO A OTRAS ALEACIONES DE ALUMINIO.

ALLUMINIO ANODIZZATO ANTIGRAFFIO - SCRATCH-RESISTANT ANODIZED ALUMINUM - ALUMINIUM ANODIZE ANTI-RAYURE - ALUMINIO ANODIZADO ANTI-ARAÑAZOS

I PROFILI ANODIZZATI DEL PROGRAMMA ART SONO STATI SOTTOPOSTI A TRATTAMENTO ANTIGRAFFIO, UNA LAVORAZIONE ESEGUITA SUCCESSIVAMENTE ALLA ANODIZZAZIONE, CHE CONFERISCE ALL'ALLUMINIO UNA PARTICOLARE RESISTENZA ALL'ABRASIONE E ALLE CONFRICAZIONI. LA MAGGIORE RESISTENZA AI GRAFFI DEI PROFILI DI ALLUMINIO TRATTATI È STATA TESTATA CON L'ABRASION RESISTANT TEST IN CONFORMITÀ ALLA NORMA INGLESE BS6161

THE ANODISED PROFILES OF THE ART PROGRAM HAVE BEEN SUBJECTED TO ANTI-SCRATCH TREATMENT, A PROCESS CARRIED OUT AFTER ANODIZING, WHICH GIVES THE ALUMINUM A PARTICULAR RESISTANCE TO ABRASION AND TO BRUISING. THE QUALITATIVE IMPROVEMENT IS BOTH IN MECHANICAL TERMS, GREATER RESISTANCE TO SCRATCHES, AND FROM THE AESTHETIC POINT OF VIEW, IMPROVING THE BRIGHTNESS OF THE ALUMINUM SURFACES. THE GREATER SCRATCH RESISTANCE OF THE TREATED ALUMINUM PROFILES HAS BEEN TESTED WITH THE ABRASION RESISTANT TEST IN COMPLIANCE WITH THE ENGLISH STANDARD BS6161.

LES PROFILÉS ANODISÉS DU PROGRAMME ART ONT ÉTÉ SOUMIS À UN TRAITEMENT ANTI-RAYURES, UN PROCÉDÉ EFFECTUÉ APRÈS ANODISATION, QUI CONFÈRE À L'ALUMINIUM UNE RÉSISTANCE PARTICULIÈRE À L'ABRASION ET AUX MEURTRISSURES. LA PLUS GRANDE RÉSISTANCE AUX RAYURES DES PROFILÉS EN ALUMINIUM TRAITÉS A ÉTÉ TESTÉE AVEC LE TEST DE RÉSISTANCE À L'ABRASION, CONFORMÉMENT À LA NORME ANGLAISE BS6161.

LOS PERFILES ANODIZADOS DEL PROGRAMA ART SE HAN SOMETIDO A UN TRATAMIENTO CONTRA LOS ARAÑAZOS, UN PROCESO EJECUTADO DESPUÉS DE LA ANODIZACIÓN, QUE DA AL ALUMINIO UNA RESISTENCIA PARTICULAR A LA ABRASIÓN Y A LOS REFREGAMIENTOS. LA MAYOR RESISTENCIA CONTRA LOS ARAÑAZOS DE LOS PERFILES DE ALUMINIO TRATADOS SE HA TESTADO CON LA PRUEBA DE RESISTENCIA A LA ABRASIÓN EN CONFORMIDAD CON LA NORMA INGLÉS BS6161.

POLIAMMIDE 6 - POLYAMIDE 6 - POLYAMIDE 6 - POLIAMIDA 6

IL POLIAMMIDE 6 È UNA RESINA TERMOPLASTICA AD ALTA RESISTENZA MECCANICA, CON OTTIMA TENACITÀ AGLI URTI ED ALTA RESISTENZA AD USURA E ABRASIONE. CLASSIFICATA COME AUTOESTINGUENTE DI CATEGORIA UL 94V-2, NON EMANA GAS TOSSICI, È UN MATERIALE SICURO, PRATICAMENTE INDEFORMABILE E MOLTO DUREVOLE.

POLYAMIDE 6 IS A THERMOPLASTIC RESIN WITH HIGH MECHANICAL RESISTANCE, EXCELLENT TOUGHNESS TO IMPACTS AND HIGH RESISTANCE TO WEAR AND ABRASION. CLASSIFIED AS A SELF-EXTINGUISHING UL 94V-2 CATEGORY, POLYAMIDE 6 DOES NOT GENERATE TOXIC GASES, IT IS A SAFE MATERIAL, HARDLY DEFORMABLE AND VERY DURABLE.

LE POLYAMIDE 6 EST UNE RÉSINE THERMOPLASTIQUE AVEC UNE RÉSISTANCE MÉCANIQUE ÉLEVÉE, UNE TRÈS BONNE DURETÉ AUX IMPACTS ET UNE HAUTE RÉSISTANCE À L'USURE ET À L'ABRASION. CLASSIFIÉ COMME AUTO-EXTINGUIBLE DE TYPE UL 94V-2, NE LIBÈRE PAS DE GAZ TOXIQUES, IL S'AGIT D'UN MATÉRIEL SÛR PRESQUE INDÉFORMABLE ET TRÈS DURABLE.



LA POLIAMIDA 6 ES UNA RESINA TERMOPLÁSTICA DE ALTA RESISTENCIA MECÁNICA, CON EXCELENTE TENACIDAD AL IMPACTO Y ALTA RESISTENCIA AL DESGASTE Y LA ABRASIÓN. CLASIFICADO COMO AUTOEXTINGUIBLE DE CLASE UL 94V-2, NO EMANA GASES TÓXICOS, ES UN MATERIAL SEGURO, PRÁCTICAMENTE INDEFORMABLE Y MUY DURADERO.

STANDARD**.75****ANTRACITE
ANTRACITE
ANTRACITE
ANTRACITA****RAIL**
Aluminum Anodized Anthracite High
corrosion resistance**ACCESSORIES**
Polyamide 6 Anthracite**SUPPORT AND BENDS**
Powder-coated Aluminum Alloy
Anthracite**.17****ANTRACITE
ANTRACITE
ANTRACITE
ANTRACITA****ACCESSORIES**
Polyamide 6 Anthracite

pba PER LA CERTIFICAZIONE LEED®

LEED® (LEADERSHIP IN ENERGY ENVIRONMENTAL DESIGN) È UN SISTEMA DI CERTIFICAZIONE A BASE VOLONTARIA PER LA GESTIONE, LA PROGETTAZIONE E LA COSTRUZIONE DI EDIFICI SOSTENIBILI DAL PUNTO DI VISTA SOCIALE, AMBIENTALE, ECONOMICO E DEL BENESSERE PER GLI UTILIZZATORI.





I PRODOTTI pba CONTRIBUISCONO AI PREREQUISITI E AI CREDITI LEED®.

PROCESSO INTEGRATO	IP	
MATERIALI E RISORSE	MR	
QUALITÀ DELL'AMBIENTE INTERNO	EQ	
INNOVAZIONE	I	

pba FOR LEED® CERTIFICATION

LEED® (LEADERSHIP IN ENERGY ENVIRONMENTAL DESIGN) IS A VOLUNTARY CERTIFICATION SYSTEM FOR THE MANAGEMENT, DESIGN AND CONSTRUCTION OF BUILDINGS THAT ARE SUSTAINABLE FROM A SOCIAL, ENVIRONMENTAL AND ECONOMIC POINT OF VIEW AND IN TERMS OF THE WELLBEING OF THE USERS.





pba PRODUCTS CONTRIBUTE TOWARD SATISFYING PREREQUISITES AND CREDITS UNDER LEED®.

INTEGRATED PROCESS	IP	
MATERIALS AND RESOURCES	MR	
INDOOR ENVIRONMENTAL QUALITY	EQ	
INNOVATION	I	

pba POUR LA CERTIFICATION LEED®

LEED® (LEADERSHIP IN ENERGY ENVIRONMENTAL DESIGN) EST UN SYSTÈME DE CERTIFICATION À BASE VOLONTAIRE POUR LA GESTION, LA CONCEPTION ET LA CONSTRUCTION DE BÂTIMENTS DURABLES D'UN POINT DE VUE SOCIAL, ENVIRONNEMENTAL, ÉCONOMIQUE ET DU BIEN-ÊTRE POUR LES UTILISATEURS.

LES PRODUITS pba CONTRIBUENT AUX CONDITIONS PRÉALABLES REQUISES ET AUX CRÉDITS LEED®.

PROCESSUS DE CONCEPTION INTÉGRÉE	IP	
MATÉRIAUX ET RESSOURCES	MR	
QUALITÉ DES ENVIRONNEMENTS INTÉRIEURS	EQ	
INNOVATION	I	

pba PARA LA CERTIFICACIÓN LEED®

LEED® (LEADERSHIP IN ENERGY ENVIRONMENTAL DESIGN) ES UN SISTEMA DE CERTIFICACIÓN DE BASE VOLUNTARIA PARA LA GESTIÓN, EL DISEÑO Y LA CONSTRUCCIÓN DE EDIFICIOS SOSTENIBLES DESDE EL PUNTO DE VISTA SOCIAL, MEDIOAMBIENTAL, ECONÓMICO Y DEL BIENESTAR PARA LOS USUARIOS.

LOS PRODUCTOS pba CONTRIBUYEN EN LOS PRE-REQUISITOS Y EN LOS CRÉDITOS LEED®.



PROCESO INTEGRADO	IP	
MATERIALES Y RECURSOS	MR	
CALIDAD DEL AMBIENTE INTERNO	EQ	
INNOVACIÓN	I	

CHART OF PBA PRODUCTS CONTRIBUTION TO LEED V4

INTEGRATIVE PROCESS

- IP PREREQUISITE INTEGRATIVE PROCESS PLANNING AND DESIGN





MATERIALS AND RESOURCES

- MR PREREQUISITE CONSTRUCTION AND DEMOLITION WASTE MANAGEMENT PLANNING
- MR CREDIT CONSTRUCTION AND DEMOLITION WASTE MANAGEMENT
- MR CREDIT BUILDING PRODUCT DISCLOSURE AND OPTIMIZATION - SOURCING OF RAW MATERIALS
➔ OPTION 2 LEADERSHIP EXTRACTION PRACTICES
- MR CREDIT BUILDING PRODUCT DISCLOSURE AND OPTIMIZATION - MATERIAL INGREDIENTS
➔ OPTION 2 MATERIAL INGREDIENT OPTIMIZATION

INDOOR ENVIRONMENTAL QUALITY

- EQ CREDIT LOW EMITTING MATERIALS
- EQ CREDIT CONSTRUCTION AIR QUALITY MANAGEMENT PLAN

INNOVATION

- IN PILOT CREDIT  DESIGN FOR FLEXIBILITY
- IN PILOT CREDIT  SOCIAL EQUITY
- IN PILOT CREDIT  INCLUSIVE DESIGN
- IN CREDIT  DESIGN FOR DECONSTRUCTION

SOSTEGNI DI SICUREZZA
SAFETY SUPPORTS
BARRES D'APPUI
ASIDEROS

Page 202

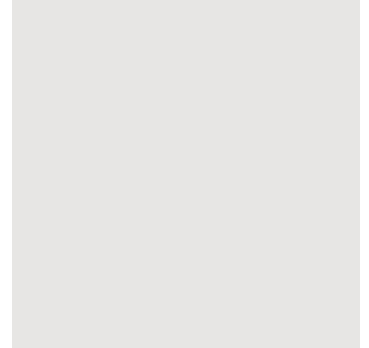

AUSILI DI SICUREZZA RIBALTABILI
LIFT-UP SAFETY SUPPORTS
BARRES D'APPUI RELEVABLES
ASIDEROS ABATIBLES

Page 208

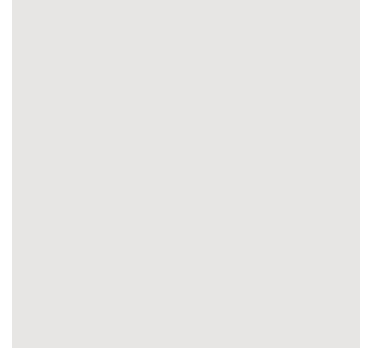
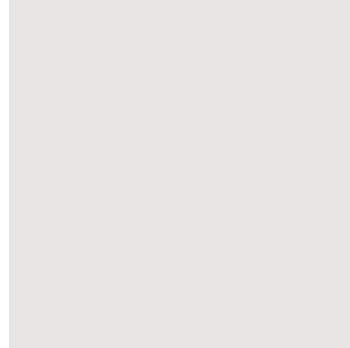

SEGGIOLINI
SEATS
SIÈGES
ASIENTOS

Page 210



ACCESSORI BAGNO
BATHROOM ACCESSORIES
ACCESSOIRES DE BAIN
ACCESORIOS DE BAÑO

Page 214



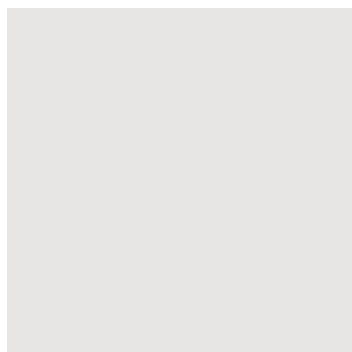
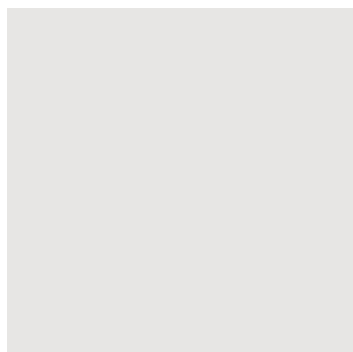
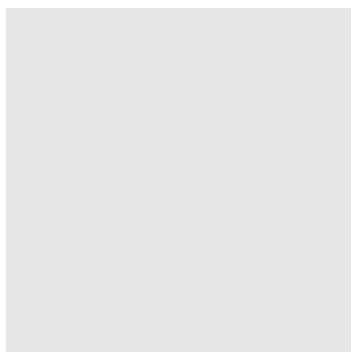
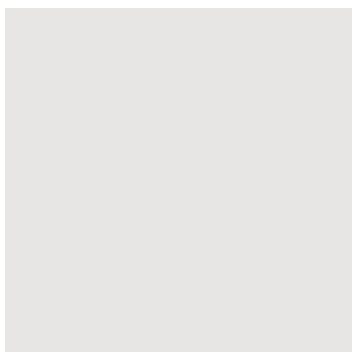
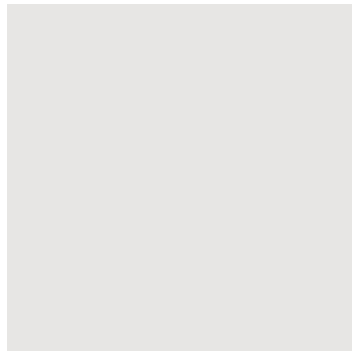
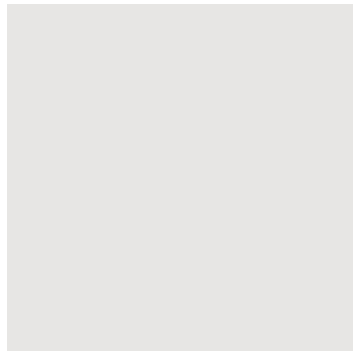
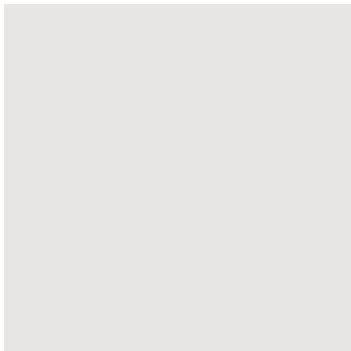
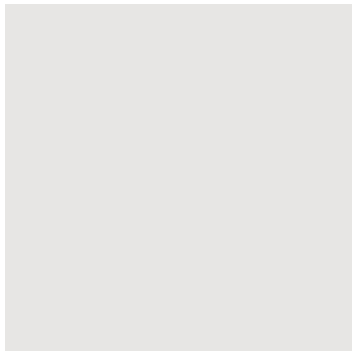
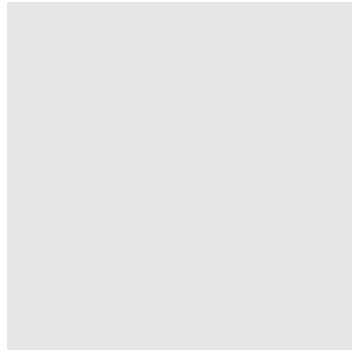
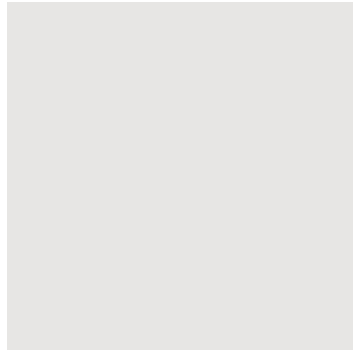
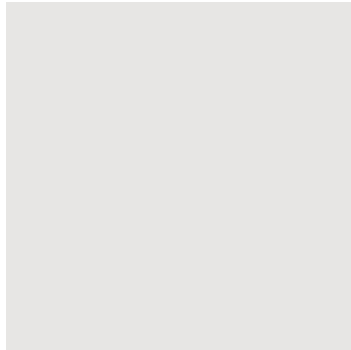
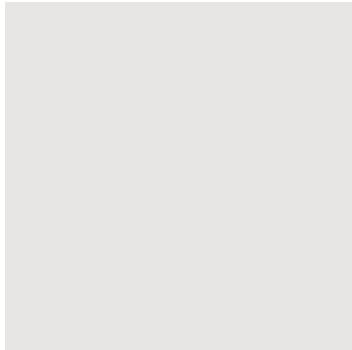
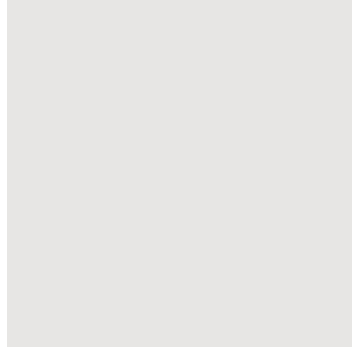
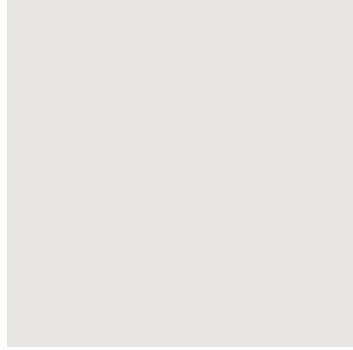
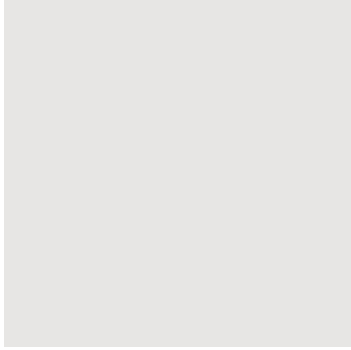
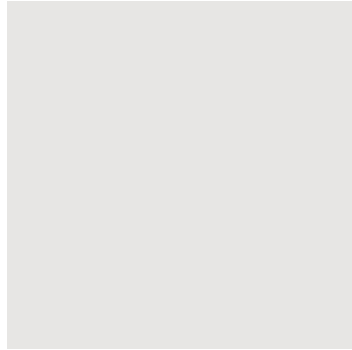
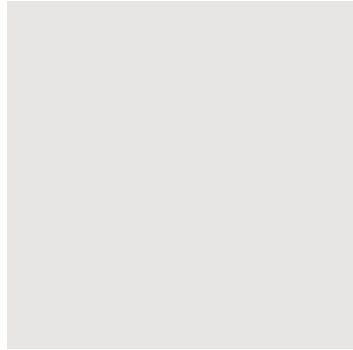
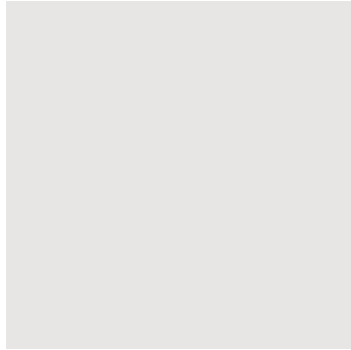
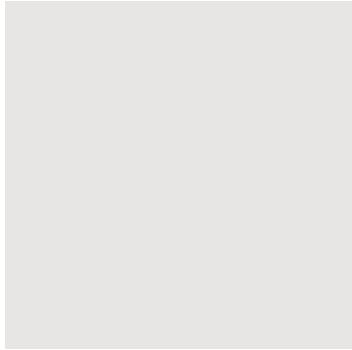





◆ RIGHT

ART.	◆	A	B
ART.422.0000.75 . x		220 (252)*	520 (552)*
ART.22J.0000.75 . x			
ART.422.000M.75 . x		300 (332)*	520 (552)*
ART.22J.000M.75 . x			
ART.422.000L.75 . x		320 (352)*	720 (752)*
ART.22J.000L.75 . x			
ART.422.00LA.75 . x		400 (432)*	1160 (1192)*
ART.22J.00LA.75 . x			
ART.422.9999.75 . x	Ⓢ		Ⓢ
ART.22J.9999.75 . x			

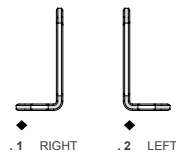
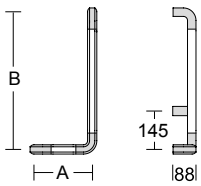

- Anodized Aluminum
- Powder-coated Aluminum Alloy

- Sostegno di sicurezza a "L"
- "L"-shaped safety support
- Barre d'appui forme à "L"
- Asidero en "L"



THESE PRODUCTS CONTRIBUTE TO LEED® CREDITS

.XX FINISH

.75



ART.	A	B
ART.433.0000.75	1570 (1600)*	820 (852)*
ART.33J.0000.75		
ART.433.9999.75	Ⓢ	Ⓢ
ART.33J.9999.75		

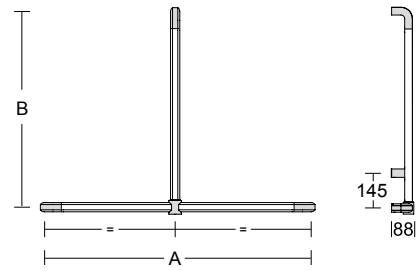

- Anodized Aluminum
- Powder-coated Aluminum Alloy

- Sostegno di sicurezza a "T"
- "T"-shaped safety support with sliding shower head rail
- Barre d'appui forme à "T"
- avec barre de douche coulissante
- Asidero en "T"
- con empuñadura vertical deslizante



- ◆
- .1 DESTRO RIGHT DROITE DERECHA
- .2 SINISTRO LEFT GAUCHE IZQUIERDA



ART.	◆	A	B	C
ART.424.0000.75 . x		660 (676)*	660 (678)*	820 (852)*
ART.24J.0000.75 . x	⚡			
ART.424.000L.75 . x		760 (776)*	400 (418)*	1160 (1192)*
ART.24J.000L.75 . x	⚡			
ART.424.00LA.75 . x		760 (776)*	760 (778)*	1160 (1192)*
ART.24J.00LA.75 . x	⚡			
ART.424.9999.75 . x	Ⓢ			
ART.24J.9999.75 . x	⚡			

ART.	◆	A	B	C
ART.443.000B.75 . x		760 (776)*	760 (776)*	1160 (1192)*
ART.43J.000B.75 . x	⚡			
ART.443.00BL.75 . x		760 (776)*	1184 (1200)*	1160 (1192)*
ART.43J.00BL.75 . x	⚡			
ART.443.999B.75 . x	Ⓢ			
ART.43J.999B.75 . x	⚡			

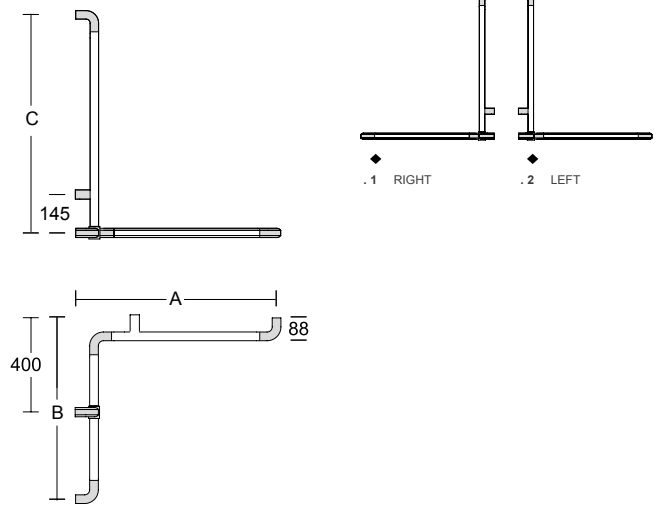
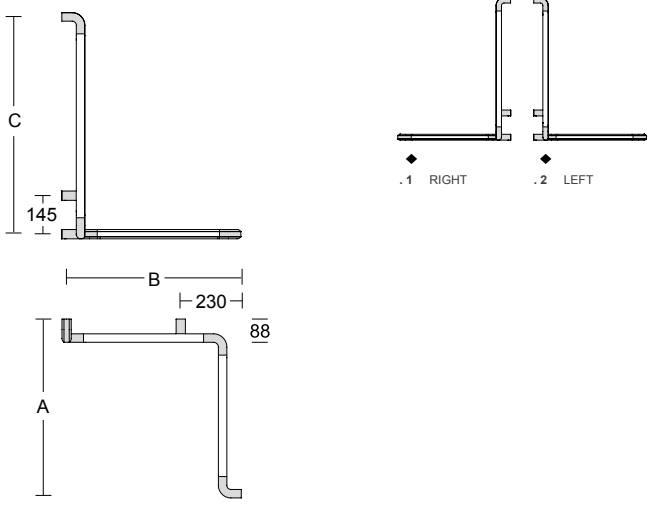

- Anodized Aluminum
- Powder-coated Aluminum Alloy

- Anodized Aluminum
- Powder-coated Aluminum Alloy

- Sostegno di sicurezza ad angolo con impugnatura verticale
- Corner safety support with shower head rail
- Barre d'appui à coin avec barre de douche
- Asidero en ángulo con empuñadura vertical



- Sostegno di sicurezza ad angolo con asta reggisoffione a scorrimento
- Corner safety support with sliding shower head rail
- Barre d'appui forme à coin avec barre de douche coulissante
- Asidero en ángulo con empuñadura vertical deslizante



THESE PRODUCTS CONTRIBUTE TO LEED® CREDITS

.XX FINISH .75

◆
 .1 DESTRO RIGHT DROITE DERECHA
 .2 SINISTRO LEFT GAUCHE IZQUIERDA



ART.	A
ART.487.0000.75	570 (600)*
ART.487.000A.75	770 (800)*
ART.487.000B.75	970 (1000)*
ART.487.000C.75	1170 (1200)*
ART.487.9999.75	

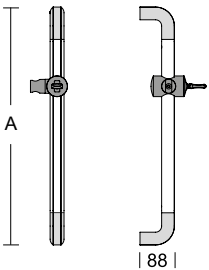

- Anodized Aluminum
- Powder-coated Aluminum Alloy
- .17 Polyamid 6 Anthracite

- Sostegno di sicurezza con reggisoffione
- Fixed safety support with shower head holder
- Barre d'appui fixe avec curseur de douche
- Asidero con soporte para ducha regulable en altura



THESE PRODUCTS CONTRIBUTE TO LEED® CREDITS

.XX FINISH

.75



ART.	A	B
ART.487.00RD.17	140*	93*

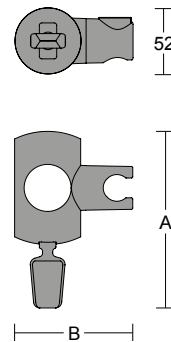

- .17 Polyamid 6 Anthracite

- Reggisoffione girevole con attacco conico universale a scorrimento compatibile con sostegni di sicurezza del PROGRAMMA ART
- Rotating shower head holder with universal sliding tapered connection compatible with all safety supports of the PROGRAMMA ART
- Curseur de douche rabatable avec élément de fixation mobile et conique universel compatible avec les barres d'appui du PROGRAMMA ART
- Soporte ducha giratorio con base cónica universal deslizable compatible con todos los asideros del PROGRAMA ART

.XX FINISH

.17





ART.	A
ART.440.0000.75	370 (400)*
ART.440.000A.75	570 (600)*
ART.440.000B.75	770 (800)*
ART.440.000C.75	970 (1000)*
ART.440.000Z.75	300 (330)*
ART.440.9999.75	☞

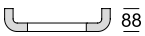
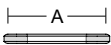

- Anodized Aluminum
- Powder-coated Aluminum Alloy

- Sostegno di sicurezza orizzontale
- Horizontal safety support
- Barre d'appui horizontale
- Asidero horizontal



THESE PRODUCTS CONTRIBUTE TO LEED® CREDITS

.XX FINISH

.75



ART.	A
ART.423.000B.75	1370 (1400)*
ART.423.00BL.75	1570 (1600)*
ART.423.999B.75	☞

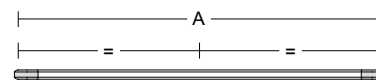

- Anodized Aluminum
- Powder-coated Aluminum Alloy

- Sostegno di sicurezza orizzontale con supporto intermedio
- Horizontal safety support with intermediate wall support
- Barre d'appui horizontale avec support intermédiaire
- Asidero horizontal con soporte intermedio





◆ RIGHT

ART.	◆	A
ART.442.0000.75 . x		760 (776)*
ART.442.000M.75 . x		960 (976)*
ART.442.000L.75 . x		1160 (1176)*
ART.442.9999.75 . x	Ⓢ	

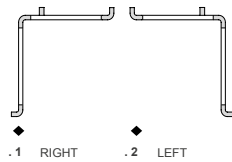
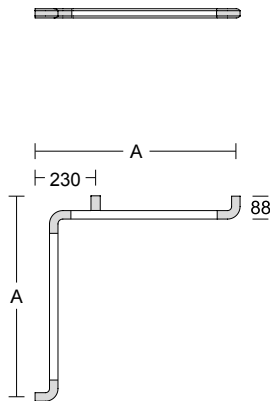

- Anodized Aluminum
- Powder-coated Aluminum Alloy

- Sostegno di sicurezza ad angolo simmetrico
- Symmetric corner safety shower rail
- Barre d'appui à coin symétrique
- Asidero en ángulo simétrico



THESE PRODUCTS CONTRIBUTE TO LEED® CREDITS

.XX FINISH

.75



P B A
PATENTED
DESIGN

PATENT
IT 0000101043

ART.	A
ART.441.000P.75	600*
ART.441.00PL.75	700*
ART.441.0PLL.75	850*

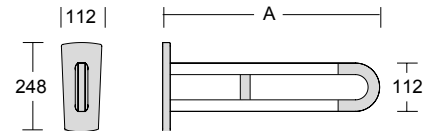

- Anodized Aluminum
- Powder-coated Aluminum Alloy

- Sostegno di sicurezza fisso su piastra
- Safety support fixed on plate
- Barre d'appui fixe sur plaque
- Asidero fijo sobre placa



- ◆
- .1 DESTRO RIGHT DROITE DERECHA
- .2 SINISTRO LEFT GAUCHE IZQUIERDA





ART.	A
ART.445.000T.75	600*
ART.45Y.000T.75	
ART.445.0000.75	700*
ART.45Y.0000.75	
ART.445.000L.75	850*
ART.45Y.000L.75	

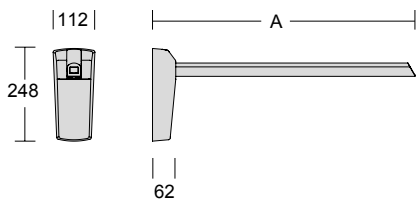
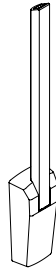

□ Powder-coated Aluminum Alloy

- Sostegno di sicurezza ribaltabile
- Lift-up safety support
- Barre d'appui rilevabile
- Asidero abatible



THESE PRODUCTS CONTRIBUTE TO LEED® CREDITS

.XX FINISH

.75







PBA
PATENTED
DESIGN

PATENT
IT 0000101043

ART.	A	B	C	D
ART.450.00CM.75	400*	510*	560*	316
ART.450.0CML.75	400*	510*	560*	386

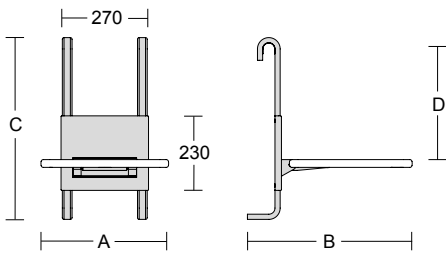

- Polyurethane
- Powder-coated Aluminum Alloy

- Seggiolino agganciabile e ribaltabile
- Lift-up suspended seat
- Siège à suspendre et relevable
- Asiento suspendido y abatible



THESE PRODUCTS CONTRIBUTE TO LEED® CREDITS

.XX FINISH

.75



PBA
PATENTED
DESIGN

PATENT
IT 0000101043

ART.	A	B
4CN.447.00CM.17	400*	415*
4CN.47K.00CM.17	400*	415*

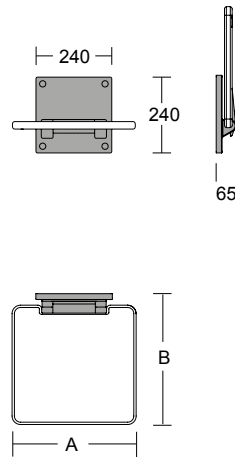

- Polyurethane
- .17 Polyamid 6 Anthracite

- Seggiolino ribaltabile
- Lift-up shower seat
- Siège relevable
- Asiento abatible



.XX FINISH

.17





ART.	A	B	C
ART.434.0000.75	490 (520)*	210*	200*
ART.434.000L.75	700 (730)*	210*	200*

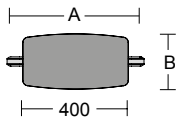

- Anodized Aluminum
- Powder-coated Aluminum Alloy
- Polyurethane

- Appoggiaschiene da WC
- WC Backrest
- Appui dos pour WC
- Respaldo de WC



THESE PRODUCTS CONTRIBUTE TO LEED® CREDITS

.XX FINISH

.75



.XX FINISH

.75

.17







ART.	A	🌀
ART.429.0000.75	800*	8
ART.429.000A.75	900*	9
ART.429.000B.75	1000*	10
ART.429.000C.75	1100*	11
ART.429.000D.75	1200*	12
ART.429.000E.75	1300*	13
ART.429.9999.75	🌀	

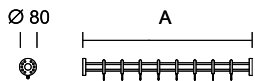

- Anodized Aluminum
- .17 Polyamid 6 Anthracite

- Reggitenda dritto
- Straight shower curtain rail
- Barre de rideau de douche droit
- Barra de cortina de ducha recta



THESE PRODUCTS CONTRIBUTE TO LEED® CREDITS

.XX FINISH

.75



ART.	A	B	🌀
ART.436.0000.75	800 (815)*	800 (815)*	16
ART.436.9999.75	🌀	🌀	

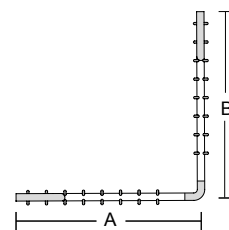
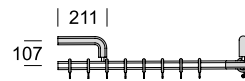

- Anodized Aluminum
- Powder-coated Aluminum Alloy
- .17 Polyamid 6 Anthracite

- Reggitenda angolare con due supporti a muro
- Corner shower curtain rail with two wall supports
- Barre de rideau de douche à coin avec deux supports murales
- Barra de cortina de ducha en ángulo con dos soportes en pared





ART.	A	B	C	
ART.436.000B.75	800 (815)*	800 (815)*	440 (458)*	16
ART.436.00BA.75	900 (915)*	900 (915)*	440 (458)*	18
ART.436.00BB.75	1000 (1015)*	1000 (1015)*	440 (458)*	20
ART.436.00BC.75	1200 (1215)*	1200 (1215)*	440 (458)*	24
ART.436.00BD.75	1500 (1515)*	1500 (1515)*	440 (458)*	30
ART.436.999B.75				

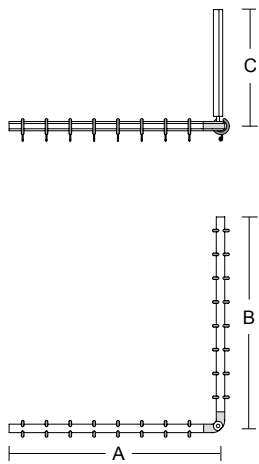

- Anodized Aluminum
- Powder-coated Aluminum Alloy
- .17 Polyamid 6 Anthracite

- Reggitenda angolare con supporto a soffitto
- Corner shower curtain rail with ceiling support
- Barre de rideau de douche à coin avec support plafond
- Barra de cortina de ducha en ángulo con soporte de techo



THESE PRODUCTS CONTRIBUTE TO LEED® CREDITS

.XX FINISH

.75



ART.	A	B	C	
ART.437.0000.75	800 (815)*	800 (830)*	440 (458)*	24
ART.437.000A.75	1000 (1015)*	1000 (1030)*	440 (458)*	30
ART.437.9999.75				

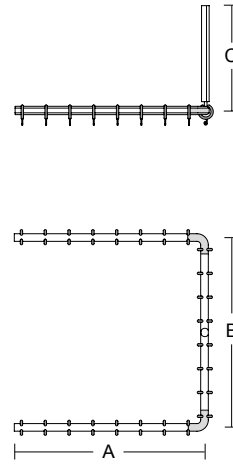

- Anodized Aluminum
- Powder-coated Aluminum Alloy
- .17 Polyamid 6 Anthracite

- Reggitenda su tre lati con supporto a soffitto
- Three-sided shower curtain rail with ceiling support
- Barre de rideau de douche sur trois côtés avec support plafond
- Barra de cortina de ducha en "U" con soporte de techo





ART.	L	H	
4CN.0SC.000B.01	1200	2000	Art. ART.429.0000 .xx
			ART.429.000A .xx
			ART.429.000B .xx
			ART.436.0000 .xx *
			ART.436.000B .xx *
			ART.436.00BA .xx *
4CN.0SC.000C.01	1800	2000	Art. ART.429.000C .xx
			ART.429.000D .xx
			ART.429.000E .xx
			ART.436.00BC .xx *
			ART.436.00BD .xx *
			ART.437.0000 .xx *
			Art. ART.437.000A .xx *

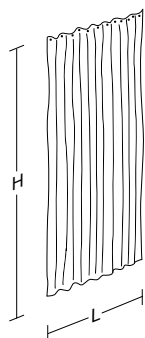

- Tenda ignifuga per doccia
- Fireproof shower curtain
- Rideau de douche ignifuge
- Cortina de ducha ignifuga

THESE PRODUCTS CONTRIBUTE TO LEED® CREDITS



ART.	L	H	
4CN.0SC.00BE.01	1200	2000	Art. ART.429.0000 .xx
			ART.429.000A .xx
4CN.0SC.00FE.01	1500	2000	Art. ART.429.000B .xx
			ART.429.000C .xx
			ART.436.00BC .xx *
			ART.437.0000 .xx *
4CN.0SC.00CE.01	1800	2000	Art. ART.429.000D .xx
			ART.429.000E .xx
			ART.436.00BD .xx *
			ART.437.000A .xx *
4CN.0SC.00DE.01	2000	2000	Art. ART.436.0000 .xx
			ART.436.000B .xx
4CN.0SC.00EE.01	2400	2000	Art. ART.436.00BA .xx
			ART.436.00BB .xx

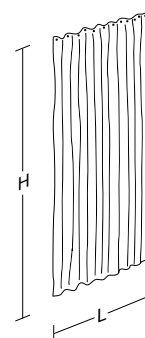

- Tenda impermeabile per doccia
- Waterproof shower curtain
- Rideau de douche imperméable
- Cortina de ducha impermeable



ART.	L	H	
4CN.0SC.00BL.01	1200	2000	Art. ART.429.0000 .xx ART.429.000A .xx
4CN.0SC.00FL.01	1500	2000	Art. ART.429.000B .xx ART.429.000C .xx ART.436.00BC .xx * ART.437.0000 .xx *
4CN.0SC.00CL.01	1800	2000	Art. ART.429.000D .xx ART.429.000E .xx ART.436.00BD .xx * ART.437.000A .xx *
4CN.0SC.00DL.01	2000	2000	Art. ART.436.0000 .xx ART.436.000B .xx
4CN.0SC.00EL.01	2400	2000	Art. ART.436.00BA .xx ART.436.00BB .xx

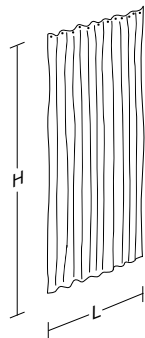

- Tenda impermeabile per doccia
- Waterproof shower curtain
- Rideau de douche imperméable
- Cortina de ducha impermeable

THESE PRODUCTS CONTRIBUTE TO LEED® CREDITS

* 2 PEZZI * 2 PIECES * 2 PIÈCES * 2 PIEZAS



ART.	A	B	C
ART.490.00QR.75	600*	700*	15

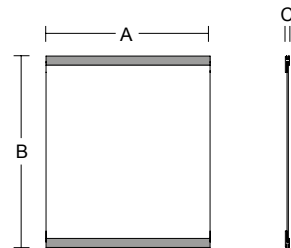

■ Powder-coated Aluminum Alloy

- Specchio fisso con cornice
- Fixed mirror with frame
- Miroir fixe avec cadre
- Espejo fijo con marco

.XX FINISH

.75





ART.	A	B	C	α
ART.470.0000.75	600*	540*	150*	14°
ART.470.000Q.75	600*	690*	190*	14°

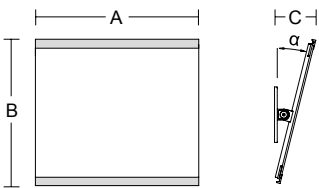

Powder-coated Aluminum Alloy

- Specchio orientabile con cornice
- Adjustable mirror with frame
- Miroir orientable avec cadre
- Espejo orientable con marco

THESE PRODUCTS CONTRIBUTE TO LEED® CREDITS

.XX FINISH

.75



ART.	A	B
ART.490.0000.75	600*	1100*

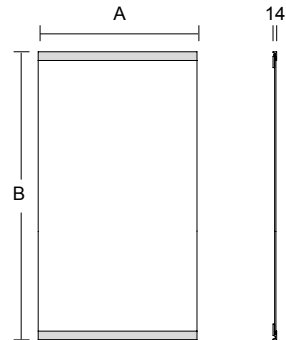

Powder-coated Aluminum Alloy

- Specchio fisso
- Fixed mirror
- Miroir fixe
- Espejo fijo



ART.	A	B
4CN.407.0TUA.17	405*	61*

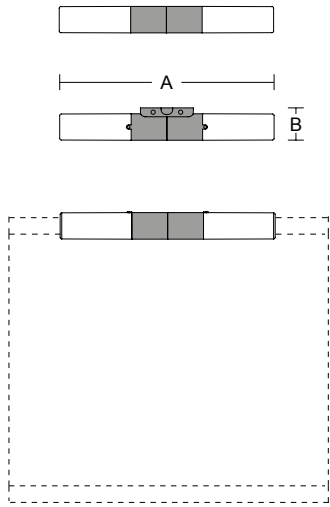

■ .17 Polyamid 6 Anthracite

- Lampada da applicare su specchi con cornice.
IP 54 con Art. 4CN.0IP.0068.00
- Lamp for mirrors with frame.
IP 54 with Art. 4CN.0IP.0068.00
- Lampe pour miroirs avec cadre
IP 54 avec Art. 4CN.0IP.0068.00
- Aplique para espejos con marco
IP 54 con Art. 4CN.0IP.0068.00

CE
IP 54

THESE PRODUCTS CONTRIBUTE TO LEED® CREDITS

.XX FINISH



ART.	A	B
4CN.407.0TUR.17	405*	77*

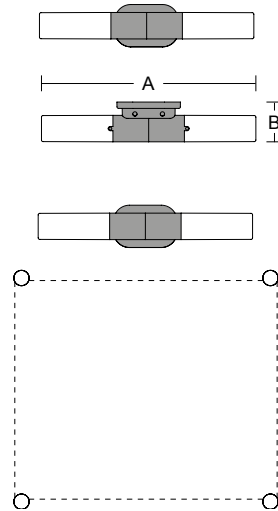

■ .17 Polyamid 6 Anthracite

- Lampada da fissare a parete.
IP 54 con Art. 4CN.0IP.0068.00
- Wall lamp for mirror.
IP 54 with Art. 4CN.0IP.0068.00
- Lampe de mur pour miroir.
IP 54 avec Art. 4CN.0IP.0068.00
- Aplique con fijación en pared
IP 54 con Art. 4CN.0IP.0068.00

CE
IP 54



ART.	A	B	C
ART.492.000B.75	210*	105*	103*

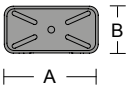
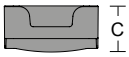

■ .17 Polyamid 6 Anthracite

- Mensola applicabile su supporto orizzontale
- Shelf to be integrated to horizontal support
- Tablette accrochable à la barre d'appui horizontale
- Estante aplicable a asidero horizontal

THESE PRODUCTS CONTRIBUTE TO LEED® CREDITS

.XX FINISH

.75



ART.	A	B	C
ART.483.00PM.75	150*	110*	44*

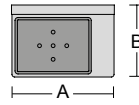
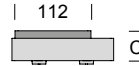

■ Powder-coated Aluminum Alloy
 ■ .17 Polyamid 6 Anthracite

- Mensola con portasapone
- Shelf with soap dish
- Tablette avec porte savon
- Estante con jabonera

.XX FINISH

.75





ART.	A	B
ART.483.0IBM.75	150*	110*

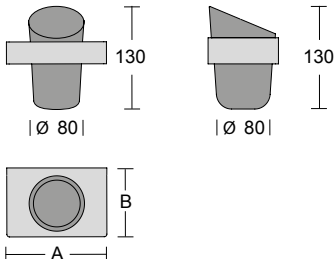

Powder-coated Aluminum Alloy
 .17 Polyamid 6 Anthracite

- Mensola con bicchiere conico
- Shelf with conical tumbler
- Tablette avec gobelet conique
- Estante con vaso cónico

THESE PRODUCTS CONTRIBUTE TO LEED® CREDITS

.XX FINISH

.75



ART.	A	B	C
ART.483.00DM.75	150*	110*	136*

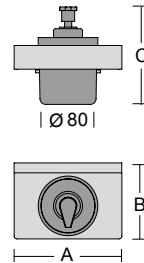

Powder-coated Aluminum Alloy
 .17 Polyamid 6 Anthracite

- Mensola con dispenser
- Shelf with soap dispenser
- Tablette avec distributeur de savon
- Estante con dispensador de jabón (It 0,4)



ART.	A	B	C
ART.481.00BA.75	150*	110	108

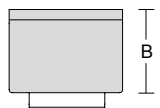
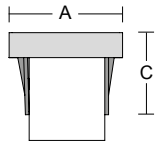

- Powder-coated Aluminum Alloy
- .17 Polyamid 6 Anthracite

- Portarotolo a muro
- Wall toilet roll holder
- Porte-papier murale
- Portarrollo de pared

THESE PRODUCTS CONTRIBUTE TO LEED® CREDITS

.XX FINISH

.75



ART.	A	B	C
ART.486.0000.75	150*	110*	380*

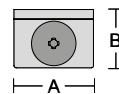
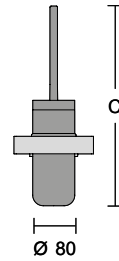

- Powder-coated Aluminum Alloy
- .17 Polyamid 6 Anthracite

- Portascopino
- Toilet brush set
- Ensemble brosse WC
- Escobillero



ART.	A	B
ART.562.0000.75	Ø 50	76*

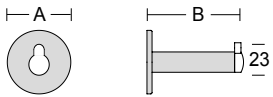

■ Powder-coated Aluminum Alloy

- Appendiabiti fermaporta
- Door-stop cloth hook
- Patère-butoir
- Tope-percha

THESE PRODUCTS CONTRIBUTE TO LEED® CREDITS

.XX FINISH

.75



ART.	A	B
ART.488.0000.75	125*	30*

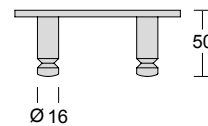
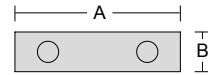

■ Powder-coated Aluminum Alloy

- Gancio appendiabiti doppio
- Double cloth hook
- Patère double
- Percha doble

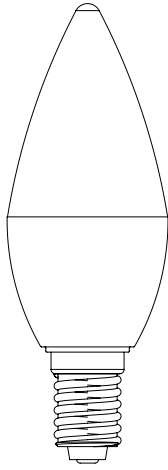

ART.

4CN.407.00LT.00

- Lampadina LED di classe energetica A+
- Light LED bulb energy class A+
- Ampoule LED de classe énergétique A+
- Bombilla LED de eficiencia energética A+

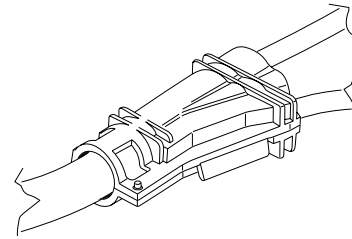

ART.

4CN.0IP.0068.00

- Giunzione rapida per cavi elettrici
- Quick junction for electric cables
- Jonction rapide pour cables électriques
- Kit conector para cables eléctricos

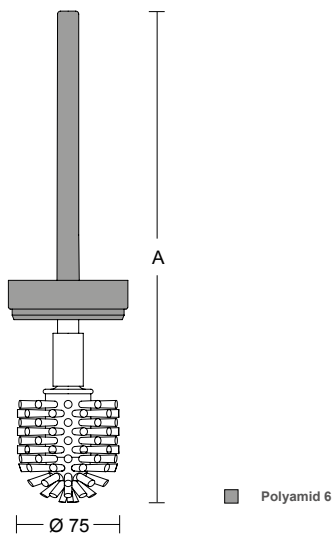

ART.

A

4CN.486.000R.17 350*

- Scopino di riserva con impugnatura
- Spare toilet brush with handle
- Brosse WC de réserve avec manche
- Escobilla de reserva con mango

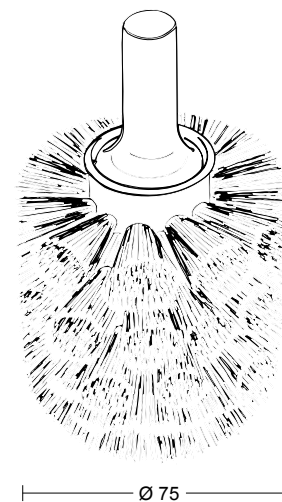

ART.

4CN.486.000B.00

- Scopino di riserva
- Spare toilet brush head
- Tête brosse WC de réserve
- Cabezal de escobilla de reserva para escobillero

THESE PRODUCTS CONTRIBUTE TO LEED® CREDITS

.XX FINISH

.17



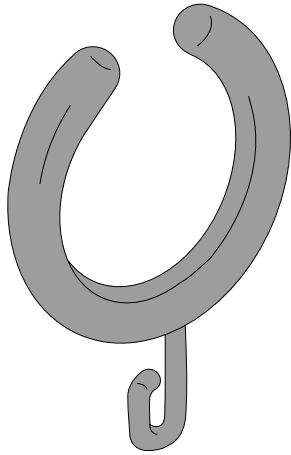

ART.
4CN.0AN.0002.17

- Anello reggitenda
- Shower curtain ring
- Anneau pour rideau de douche
- Anillas para cortina

■ Polyamid 6

.XX FINISH

.17



THESE PRODUCTS CONTRIBUTE TO LEED® CREDITS

PROGRAMMA PBA WF

PATENT PENDING ITALY 102019000013932
PATENT DEUTCHLAND 202020104488.5

PBA
PATENTED
SYSTEM

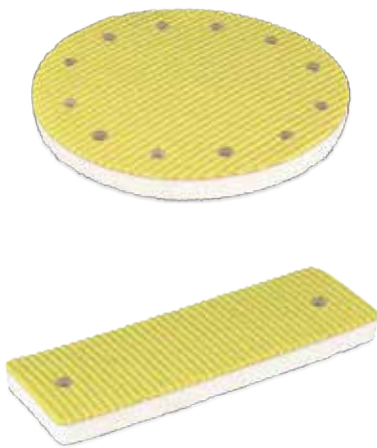

ART.
4CN.0VM.WF40.00

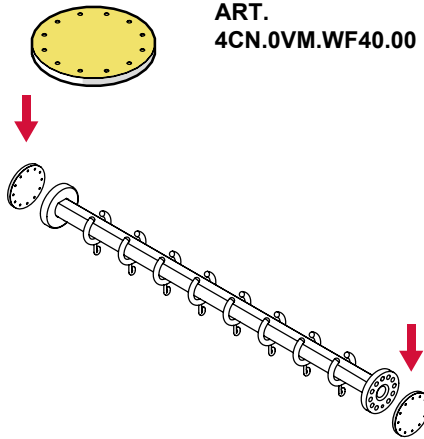

Articles with fixing rose



ART.
4CN.0VM.WF41.00

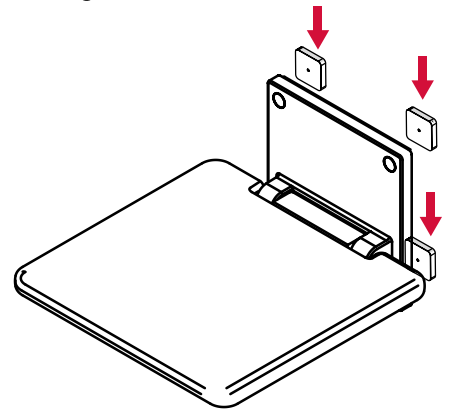

Shower seat with plate and lift-up support



ART.
4CN.0VM.WF47.00

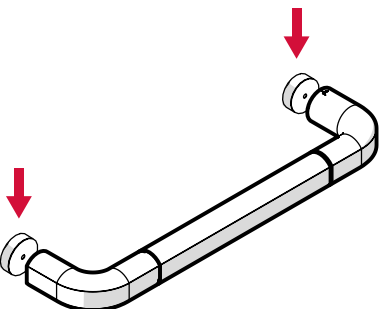

Safety support CAP and ART

PROGRAMMA 400-SS





ACCIAIO INOX - STAINLESS STEEL - ACIER INOXIDABLE - ACERO INOXIDABLE : AISI 316L

L'ACCIAIO INOX AISI 316L È UNA LEGA AUSTENITICA. SI DISTINGUE DALLE ALTRE LEGHE DI ACCIAIO INOSSIDABILE PER L'ALTA PERCENTUALE DI MOLIBDENO CHE GARANTISCE UNA RESISTENZA SUPERIORE ALLA CORROSIONE E AGLI AGENTI ATMOSFERICI. IN QUESTA LEGA È MAGGIORE ANCHE LA PERCENTUALE DI NICKEL PER GARANTIRE UNA MAGGIORE STABILITÀ. INOLTRE LA LETTERA "L" INDICA UN BASSO CONTENUTO DI CARBONE. QUESTA CARATTERISTICA PROLUNGA I TEMPI DI PRECIPITAZIONE DEL CROMO-CARBURIO EVITANDO IL RISCHIO DI CORROSIONE DOPO LA SALDATURA.

AISI 316L STAINLESS STEEL IS AN AUSTENITIC ALLOY. ITS DIFFERENCE FROM OTHERS STAINLESS STEEL ALLOYS IS THE HIGH PERCENTAGE OF MOLYBDENUM WHICH GUARANTEES A SPECIAL RESISTANCE TO CORROSION AND WEATHERING. THE HIGHER PERCENTAGE OF NICKEL ALSO GUARANTEES GREATER STABILITY. THE LETTER "L" INDICATES A LOW CARBON CONTENT THAT REDUCES THE RISK OF CORROSION FOLLOWING THE WELDING PROCESS.

L'ACIER INOXYDABLE AISI 316L EST UN ALLIAGE AUSTÉNITIQUE. IL SE DISTINGUE DES AUTRES ACIERS INOXYDABLES PAR SON POURCENTAGE ÉLEVÉ DE MOLYBDÈNE, CE QUI LUI CONFÈRE UNE RÉSISTANCE PARTICULIÈRE À LA CORROSION PAR PIQÛRE ET À LA CORROSION SOUS CONTRAINTE. DANS CE TYPE D'ACIER INOXYDABLE, LA PRÉSENCE DE NICKEL EST ACCRUE AFIN DE GARANTIR LA STABILITÉ. DE PLUS, LE «L» INDIQUÉ DANS LA DÉFINITION AISI 316 SIGNIFIQUE FAIBLE ÉMISSION DE CARBONE. CETTE CARACTÉRISTIQUE PROLONGE LA DURÉE DE PRÉCIPITATION DES CARBURES DE CHROME ET ÉVITE LES RISQUES DE CORROSION INTERGRANULAIRE PENDANT LE PROCESSUS DE SOUDAGE.

EL ACERO INOXIDABLE AISI 316L ES UNA ALEACIÓN AUSTENÍTICA. SE DISTINGUE DE OTROS ACEROS INOXIDABLES POR EL ALTO PORCENTAJE DE MOLIBDENO QUE LE CONFIERE UNA RESISTENCIA ESPECIAL A LA CORROSIÓN POR PICADURA Y LA CORROSIÓN POR TENSIÓN. EN ESTE TIPO DE ACERO INOXIDABLE SE AUMENTA LA PRESENCIA DE NÍQUEL PARA GARANTIZAR LA ESTABILIDAD. ADEMÁS, LA "L" EN LA DEFINICIÓN INDICA BAJAS EMISIONES DE CARBONO. ESTA CARACTERÍSTICA PROLONGA EL TIEMPO DE PRECIPITACIÓN DE LOS CARBUROS DE CROMO Y EVITA EL RIESGO DE CORROSIÓN INTERGRANULAR DURANTE EL PROCESO DE SOLDADURA.

LRV - LIGHT REFLECTION VALUE *

L'LRV (LIGHT REFLECTANCE VALUE – INDICE DI RIFLETTENZA DELLA LUCE) SI BASA SU UNA SCALA DA 0 A 100: LO 0, RAPPRESENTA UNA SUPERFICIE PERFETTAMENTE ASSORBENTE CHE POTREBBE ESSERE CONSIDERATA COME TOTALMENTE NERA, MENTRE IL 100, RAPPRESENTA UNA SUPERFICIE PERFETTAMENTE RIFLETTEnte CHE POTREBBE ESSERE CONSIDERATA COME PERFETTAMENTE BIANCA. IL CONTRASTO VISIVO È DATO COME DIFFERENZA DI LRV TRA DUE SUPERFICI. I PRINCIPI LEGATI ALLA PERCEZIONE DELL'INFORMAZIONE DELL'UNIVERSAL DESIGN STABILISCONO CHE IL PROGETTO ARCHITETTONICO DEVE COMUNICARE LE INFORMAZIONI IN MODO EFFICACE INDIPENDENTEMENTE DALLE CONDIZIONI AMBIENTALI.

THE LRV (LIGHT REFLECTANCE VALUE) IS BASED ON A SCALE OF 0:100: THE 0, WHICH IS A PERFECTLY ABSORBING SURFACE THAT COULD BE ASSUMED TO BE TOTALLY BLACK, AND THE 100, WHICH IS A PERFECTLY REFLECTIVE SURFACE THAT COULD BE CONSIDERED TO BE THE PERFECT WHITE. THE VISUAL CONTRAST IS GIVEN AS A DIFFERENCE IN LRV BETWEEN TWO SURFACES. THE PERCEPTIBLE INFORMATION PRINCIPLES OF THE UNIVERSAL DESIGN STATES THAT THE DESIGN HAS TO COMMUNICATE INFORMATION EFFECTIVELY REGARDLESS OF AMBIENT CONDITIONS.

LE COEFFICIENT DE RÉFLEXION LUMINEUSE (LRV) SE BASE SUR UNE ÉCHELLE DE 0:100 : LE 0, QUI EST UNE SURFACE PARFAITEMENT ABSORBANTE QUI PEUT ÊTRE CONSIDÉRÉE TOTALEMENT NOIR ET LE 100, QUI EST UNE SURFACE PARFAITEMENT RÉFLÉCHISSANTE QUI PEUT ÊTRE CONSIDÉRÉE COMME LE BLANC PUR. LE CONTRASTE VISUEL EST LE RÉSULTAT DE LA DIFFÉRENCE DU COEFFICIENT DE RÉFLEXION LUMINEUSE (LRV) ENTRE DEUX SURFACES. LES PRINCIPES DU DESIGN UNIVERSEL AFFIRMENT QUE LE DESIGN DOIT COMMUNIQUER EFFICACEMENT LES INFORMATIONS QUELLES QUE SOIENT LES CONDITIONS DE L'ENVIRONNEMENT.

EL LRV (LIGHT REFLECTANCE VALUE - VALOR DE REFLECTANCIA DE LA LUZ) SE BASA EN UNA ESCALA QUE VA DESDE 0 HASTA 100: EL 0 REPRESENTA UNA SUPERFICIE PERFECTAMENTE ABSORBENTE QUE PODRÍA SER ASUMIDA A SER TOTALMENTE NEGRO, Y EL 100, QUE REPRESENTA UNA SUPERFICIE PERFECTAMENTE REFLECTANTE QUE PODRÍA SER CONSIDERADO A SER EL BLANCO PERFECTO. EL CONTRASTE VISUAL SE ALCANZA COMO DIFERENCIA DE LRV ENTRE DOS SUPERFICIES. LOS PRINCIPIOS DE INFORMACIÓN PERCEPTIBLE DEL DISEÑO UNIVERSAL DECLARAN QUE EL PROYECTO ARQUITECTURAL DEBE TRANSMITIR LAS INFORMACIONES DE MANERA EFECTIVA SIN IMPORTAR LAS CONDICIONES DEL AMBIENTE.

pba ANTI-MICROBIAL COATING



I PRODOTTI IN ALLUMINIO HANNO PROPRIETÀ ANTIBATTERICHE NATURALI E UNA BUONA MANEGGEVOLEZZA PER LA PULIZIA. IL RIVESTIMENTO ANTIMICROBICO pba (AMC) È UNA FINITURA INNOVATIVA ALTAMENTE CONSIGLIATA PER TUTTE LE SITUAZIONI IN CUI L'IGIENE È ESTREMAMENTE IMPORTANTE NON SOLO PER LA DESTINAZIONE, MA ANCHE PER L'ALTA FREQUENTAZIONE COME GLI OSPEDALI E SPAZI PUBBLICI IN GENERE. AMC È DISPONIBILE PER TUTTE LE SERIE ALLUMINIO SU RICHIESTA.

IL RIVESTIMENTO ANTIMICROBICO pba (AMC) CONTIENE ADDITIVI SPECIALI CHE RENDONO LA SUPERFICIE PROTETTA DA BATTERI E MICRORGANISMI. I TEST DIMOSTRANO CHE SU SUPERFICI NON TRATTATE MICROBI E BATTERI POSSONO PROLIFERARE FACILMENTE MENTRE SULLE SUPERFICI TRATTATE LA PROLIFERAZIONE È PRATICAMENTE RIDOTTA A ZERO.

PRODUCTS IN ALUMINIUM HAVE NATURAL ANTIBACTERIAL PROPERTIES AND A GOOD HANDLE ON CLEANLINESS. pba ANTI-MICROBIAL COATING (AMC) IS AN INNOVATIVE FINISHING HIGHLY RECOMMENDED FOR ALL SITUATIONS WHERE HYGIENE IS EXTREMELY IMPORTANT NOT ONLY FOR THE DESTINATION, BUT ALSO FOR THE HIGH ATTENDANCE LIKE HOSPITALS AND GENERALLY PUBLIC AND SPACES. AMC IS AVAILABLE FOR ALL THE ALUMINIUM SERIES ON REQUEST. THE pba ANTI-MICROBIAL COATING (AMC) SURFACE FINISHING CONTAINS SPECIAL ADDITIVES THAT MAKE THE SURFACE PROTECTED FROM BACTERIA AND MICROORGANISMS. THE TESTS SHOW THAT ON UNTREATED SURFACES THE MICROBES AND BACTERIA CAN EASILY PROLIFERATE WHILE ON THE TREATED SURFACES THE BACTERIAL PROLIFERATION IS PRACTICALLY ZEROED.

LES PRODUITS EN ALUMINIUM ONT DES PROPRIÉTÉS ANTI-MICROBIENNES NATURELLES ET PERMETTENT UNE PROPRIÉTÉ FACILE. LE REVÊTEMENT ANTI-MICROBIEN pba (AMC) EST UNE FINITION INNOVANTE HAUTEMENT RECOMMANDÉE POUR TOUTES LES ESPACES OÙ L'HYGIÈNE EST EXTRÊMEMENT IMPORTANTE PAS SEULEMENT POUR LE BUT MÊME, MAIS AUSSI POUR LA HAUTE FRÉQUENTATION COMME LES HÔPITAUX, BUREAUX, HÔTELS ET ESPACES PUBLICS GÉNÉRAUX. LE RAM EST DISPONIBLE POUR TOUS LES SÉRIES EN ALUMINIUM À LA DEMANDE. LE REVÊTEMENT ANTI-MICROBIEN pba (AMC) CONTIENT DES ADDITIFS SPÉCIAUX QUI PROTÈGENT LA SURFACE CONTRE LES BACTÉRIES ET LES MICRO-ORGANISMES. LES TESTS MONTRENT QUE SUR LES SURFACES TRAITÉES LA PROLIFÉRATION BACTÉRIENNE EST RÉDUITE PRATIQUÉMENT À ZÉRO.

LOS PRODUCTOS DE ALUMINIO TIENEN PROPIEDADES ANTIBACTERIANAS NATURALES Y PERMITEN LIMPIAR FÁCILMENTE. EL RECUBRIMIENTO ANTI-MICROBIANO pba (AMC) ES UN ACABADO INNOVADOR RECOMENDADO PARA TODAS LAS SITUACIONES EN LAS QUE LA HIGIENE ES MUY IMPORTANTE NO SOLO PARA EL AMBIENTE, SINO TAMBIÉN PARA LA ALTA PRESENCIA, COMO HOSPITALES, OFICINAS, HOTELES Y EN GENERAL ESPACIOS PÚBLICOS. EL ACABADO AMC ESTÁ DISPONIBLE PARA LAS SERIE DE ALUMINIO BAJO PETICIÓN.

EL RECUBRIMIENTO ANTI-MICROBIANO pba (AMC) CONTIENE ADITIVOS ESPECIALES QUE HACEN PROTEGER LA SUPERFICIE CONTRA LAS BACTERIAS Y LOS MICROORGANISMOS. LAS PRUEBAS HAN DEMOSTRADO QUE LA PROLIFERACIÓN DE BACTERIAS SOBRE LAS SUPERFICIES TRATADAS ES REDUCIDA A CERO.

STANDARD

.44 LRV* 53

SATINATO
SATIN
SATINE
MATE



RAIL
Stainless Steel AISI 316L
ACCESSORIES
Stainless Steel AISI 316L
SUPPORT AND BENDS
Stainless Steel AISI 316L

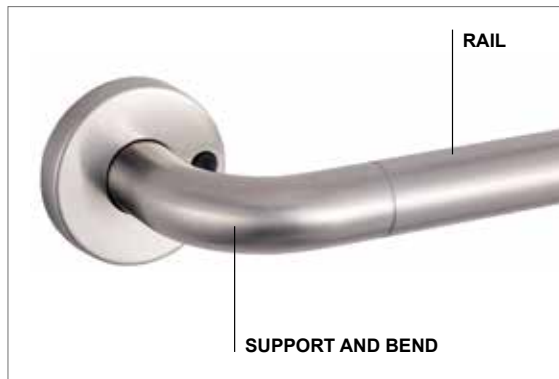

.43 LRV* 70

LUCIDO
BRIGHT
POLI
BRILLO



RAIL
Stainless Steel AISI 316L
ACCESSORIES
Stainless Steel AISI 316L
SUPPORT AND BENDS
Stainless Steel AISI 316L

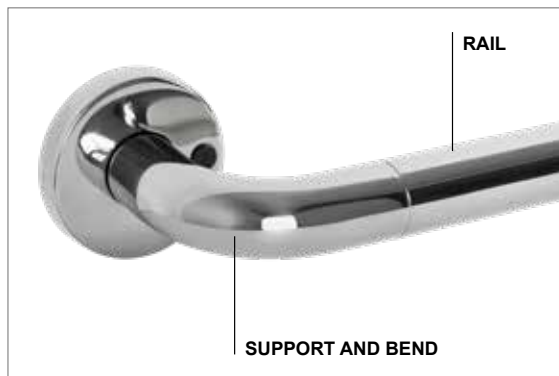

ACCESSORIES

.17

ANTRACITE
ANTHRACITE
ANTHRACITE
ANTRACITA





ACCESSORIES
Polyamide 6

pba PER LA CERTIFICAZIONE LEED®

LEED® (LEADERSHIP IN ENERGY ENVIRONMENTAL DESIGN) È UN SISTEMA DI CERTIFICAZIONE A BASE VOLONTARIA PER LA GESTIONE, LA PROGETTAZIONE E LA COSTRUZIONE DI EDIFICI SOSTENIBILI DAL PUNTO DI VISTA SOCIALE, AMBIENTALE, ECONOMICO E DEL BENESSERE PER GLI UTILIZZATORI.



I PRODOTTI pba CONTRIBUISCONO AI PREREQUISITI E AI CREDITI LEED®.

PROCESSO INTEGRATO	IP	
MATERIALI E RISORSE	MR	
QUALITÀ DELL'AMBIENTE INTERNO	EQ	
INNOVAZIONE	I	

pba FOR LEED® CERTIFICATION

LEED® (LEADERSHIP IN ENERGY ENVIRONMENTAL DESIGN) IS A VOLUNTARY CERTIFICATION SYSTEM FOR THE MANAGEMENT, DESIGN AND CONSTRUCTION OF BUILDINGS THAT ARE SUSTAINABLE FROM A SOCIAL, ENVIRONMENTAL AND ECONOMIC POINT OF VIEW AND IN TERMS OF THE WELLBEING OF THE USERS.



pba PRODUCTS CONTRIBUTE TOWARD SATISFYING PREREQUISITES AND CREDITS UNDER LEED®.

INTEGRATED PROCESS	IP	
MATERIALS AND RESOURCES	MR	
INDOOR ENVIRONMENTAL QUALITY	EQ	
INNOVATION	I	

pba POUR LA CERTIFICATION LEED®

LEED® (LEADERSHIP IN ENERGY ENVIRONMENTAL DESIGN) EST UN SYSTÈME DE CERTIFICATION À BASE VOLONTAIRE POUR LA GESTION, LA CONCEPTION ET LA CONSTRUCTION DE BÂTIMENTS DURABLES D'UN POINT DE VUE SOCIAL, ENVIRONNEMENTAL, ÉCONOMIQUE ET DU BIEN-ÊTRE POUR LES UTILISATEURS.

LES PRODUITS pba CONTRIBUENT AUX CONDITIONS PRÉALABLES REQUISES ET AUX CRÉDITS LEED®.

PROCESSUS DE CONCEPTION INTÉGRÉE	IP	
MATÉRIAUX ET RESSOURCES	MR	
QUALITÉ DES ENVIRONNEMENTS INTÉRIEURS	EQ	
INNOVATION	I	

pba PARA LA CERTIFICACIÓN LEED®

LEED® (LEADERSHIP IN ENERGY ENVIRONMENTAL DESIGN) ES UN SISTEMA DE CERTIFICACIÓN DE BASE VOLUNTARIA PARA LA GESTIÓN, EL DISEÑO Y LA CONSTRUCCIÓN DE EDIFICIOS SOSTENIBLES DESDE EL PUNTO DE VISTA SOCIAL, MEDIOAMBIENTAL, ECONÓMICO Y DEL BIENESTAR PARA LOS USUARIOS.

LOS PRODUCTOS pba CONTRIBUYEN EN LOS PRE-REQUISITOS Y EN LOS CRÉDITOS LEED®.

PROCESO INTEGRADO	IP	
MATERIALES Y RECURSOS	MR	
CALIDAD DEL AMBIENTE INTERNO	EQ	
INNOVACIÓN	I	

CHART OF PBA PRODUCTS CONTRIBUTION TO LEED V4

INTEGRATIVE PROCESS

- IP PREREQUISITE INTEGRATIVE PROCESS PLANNING AND DESIGN

MATERIALS AND RESOURCES

- MR PREREQUISITE CONSTRUCTION AND DEMOLITION WASTE MANAGEMENT PLANNING
- MR CREDIT CONSTRUCTION AND DEMOLITION WASTE MANAGEMENT
- MR CREDIT BUILDING PRODUCT DISCLOSURE AND OPTIMIZATION - SOURCING OF RAW MATERIALS
➔ OPTION 2 LEADERSHIP EXTRACTION PRACTICES
- MR CREDIT BUILDING PRODUCT DISCLOSURE AND OPTIMIZATION - MATERIAL INGREDIENTS
➔ OPTION 2 MATERIAL INGREDIENT OPTIMIZATION

INDOOR ENVIRONMENTAL QUALITY

- EQ CREDIT LOW EMITTING MATERIALS
- EQ CREDIT CONSTRUCTION AIR QUALITY MANAGEMENT PLAN

INNOVATION

- IN PILOT CREDIT ➤ DESIGN FOR FLEXIBILITY
- IN PILOT CREDIT ➤ SOCIAL EQUITY
- IN PILOT CREDIT ➤ INCLUSIVE DESIGN
- IN CREDIT ➤ DESIGN FOR DECONSTRUCTION

DECLARE LABEL

L'**ETICHETTA DECLARE** ELENCA I MATERIALI UTILIZZATI NEL PRODOTTO CON LO SCOPO DI FAR SAPERE DI COSA SONO FATTI, DOVE VENGONO PRODOTTI E COME VERRANNO SMALTITI. L'ETICHETTA DECLARE È UN INVITO ALLA RESPONSABILITÀ SIA PER I PRODUTTORI CHE PER GLI UTILIZZATORI.

LA **DECLARE LABEL** È UNA GUIDA PER SELEZIONARE I PRODOTTI, FORNISCE INFORMAZIONI IN MODO SEMPLICE E TRASPARENTE E METTE IN SOFFITTA IL GREENWASHING DECLARE, PER DEFINIRE E DICHIARARE CHE I PRODOTTI SONO PRIVI DI SOSTANZE CHIMICHE DANNOSE, FA COMPLESSE ANALISI CHIMICHE E REPERISCE INFORMAZIONI A PARTIRE DALLA FONTE DELLE MATERIE PRIME. TUTTE LE DECLARE LABEL DEI PRODOTTI pba SONO **RED LIST FREE**.

DECLARE LABEL

THE **DECLARE LABEL** LISTS THE MATERIALS IN A PRODUCT TO DISCLOSE WHAT THEY ARE MADE OF, WHERE THEY ARE PRODUCED AND HOW THEY WILL BE DISPOSED OF. THIS LABEL IS A CALL FOR RESPONSIBILITY TO PRODUCERS AND USERS ALIKE.

THE **DECLARE LABEL** IS A GUIDE TO SELECT PRODUCTS, PROVIDES INFORMATION IN A SIMPLE AND TRANSPARENT WAY AND RISES ABOVE GREENWASHING.

DECLARE TAKES COMPLEX CHEMICAL ANALYSIS AND RAW MATERIAL SOURCE LOCATION INFORMATION TO ESTABLISH THAT PRODUCTS ARE FREE FROM HAZARDOUS CHEMICALS. ALL DECLARE LABEL OF pba PRODUCTS ARE **RED LIST FREE**.

DECLARE LABEL

L'**ÉTIQUETTE DECLARE** LISTE LES MATÉRIAUX UTILISÉS DANS LES PRODUITS AFIN DE FAIRE SAVOIR DE QUOI SONT FAITS, OÙ ILS SONT FABRIQUÉS ET COMMENT LES ÉLIMINER. L'ÉTIQUETTE DECLARE EST UNE INVITATION À LA RESPONSABILITÉ SOIT POUR LES PRODUCTEURS SOIT POUR LES UTILISATEURS.

LA **DECLARE LABEL** EST UNE GUIDE POUR SÉLECTIONNER LES PRODUITS, ELLE FOURNIT INFORMATIONS DE MANIÈRE SIMPLE ET TRASPARENTE ET ÉLIMINE L'ÉCOBLANCHIMENT.

DECLARE, POUR DÉFINIR ET DÉCLARER QUE LES PRODUITS NE CONTIENNENT PAS DE SUBSTANCES NUISIBLES, FAIT DES ANALYSES CHIMIQUES COMPLEXES ET RECHERCHE INFORMATIONS À PARTIR DE LA SOURCE DES MATIÈRES PREMIÈRES.

TOUS LES ÉTIQUETTE DECLARE DES PRODUITS pba SONT **RED LIST FREE**, C'EST À DIRE QUI NE CONTIENNENT PAS D'INGRÉDIENTS FIGURANT DANS LA LISTE ROUGE.

DECLARE LABEL

LA **ETIQUETA DECLARE** HACE UNA LISTA DE LOS MATERIALES UTILIZADOS EN EL PRODUCTO CON EL OBJETIVO DE INFORMAR DE QUÉ SE COMPONEN, DÓNDE SE HACEN Y CÓMO SE ELIMINAN. LA ETIQUETA DECLARE ES UNA INVITACIÓN A LA RESPONSABILIDAD TANTO PARA LOS FABRICANTES COMO PARA LOS USUARIOS.

LA **DECLARE LABEL** ES UNA GUÍA PARA LA SELECCIÓN DE PRODUCTOS, DA INFORMACIONES DE MANERA SIMPLE Y TRASPARENTE Y SUPRIME EL ECOBLANQUEAMIENTO.

DECLARE, AL FIN DE DEFINIR Y DECLARAR QUE LOS PRODUCTOS NO CONTIENEN SUSTANCIAS QUÍMICAS DAÑOSAS, HACE ANÁLISIS QUÍMICAS COMPLEJAS Y OBTIENE INFORMACIONES A PARTIR DE LA ORIGEN DE LAS MATERIAS PRIMAS. TODAS LAS ETIQUETAS DECLARE DE LOS PRODUCTOS pba SON **RED LIST FREE**, O SEA QUE SUS COMPONENTES NO ESTÁN PRESENTE EN LA LISTA ROJA.



Declare.

STAINLESS STEEL BATHROOM ACCESSORIES AND GRAB BARS pba

Final Assembly: Tezze sul Brenta, Vicenza, Italy

Life Expectancy: 20 Year(s)

End of Life Options: Recyclable (100%)

Ingredients:

Stainless Steel AISI 316L: Stainless Steel AISI 316; **Aluminium 47100:** Aluminum; **Stainless Steel AISI 304:** Stainless Steel AISI 316; **Polyamide 6:** Nylon 6; **Stainless Steel AISI 303:** Stainless Steel AISI 316; **Brass:** Brass; **Powder coat:** Fatty acids, castor-oil, caustic-oxidized, distn. residues, esters with 1,3-butanediol; Barium sulfate; Titanium dioxide; N,N,N',N'-Tetrakis(2-hydroxyethyl)hexane diamide

Living Building Challenge Criteria: Compliant

I-13 Red List:

- LBC Red List Free % Disclosed: 100% at 100ppm
- LBC Red List Approved VOC Content: Not Applicable
- Declared

I-10 Interior Performance: Not Applicable

I-14 Responsible Sourcing: Not Applicable

PBA-0005

Original Issue Date: 2021

MANUFACTURER RESPONSIBLE FOR LABEL ACCURACY
INTERNATIONAL LIVING FUTURE INSTITUTE™ living-future.org/declare

SOSTEGNI DI SICUREZZA
SAFETY SUPPORTS
BARRES D'APPUI
ASIDEROS

Page 238



AUSILI DI SICUREZZA RIBALTABILI
LIFT-UP SAFETY SUPPORTS
BARRES D'APPUI RELEVABLES
ASIDEROS ABATIBLES

Page 248

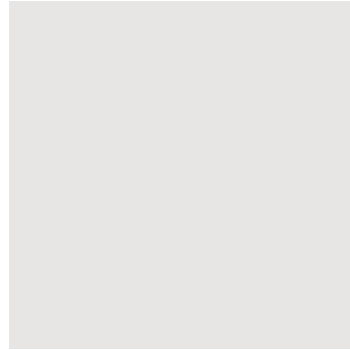

SEGGIOLINI
SEATS
SIÈGES
ASIENTOS

Page 256



ACCESSORI BAGNO
BATHROOM ACCESSORIES
ACCESSOIRES DE BAIN
ACCESORIOS DE BAÑO

Page 260



SERIE ANTISUICIDE
ANTISUICIDE SERIE
SÉRIE ANTISUICIDE
SERIE ANTISUICIDE

Page 284

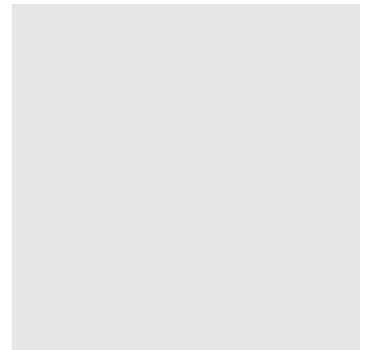
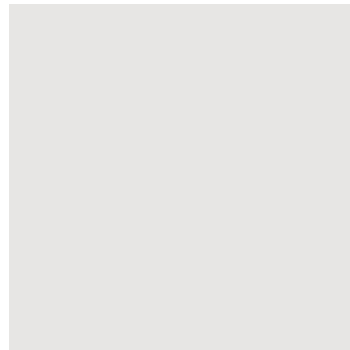
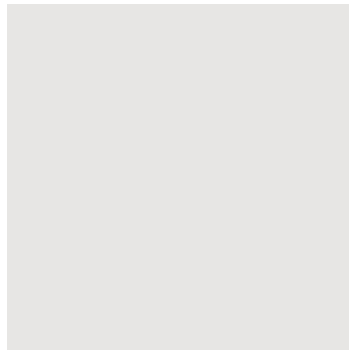
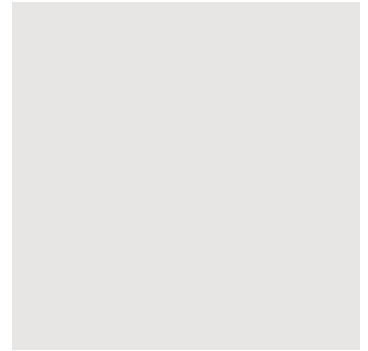
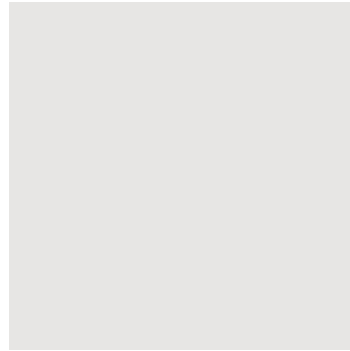

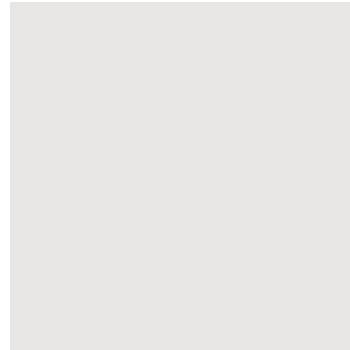
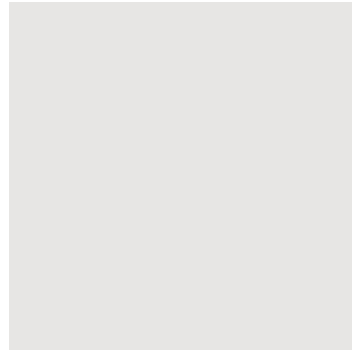
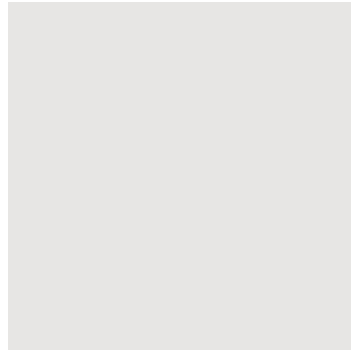
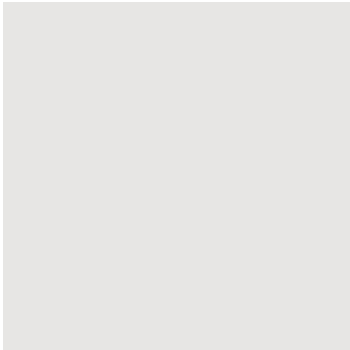
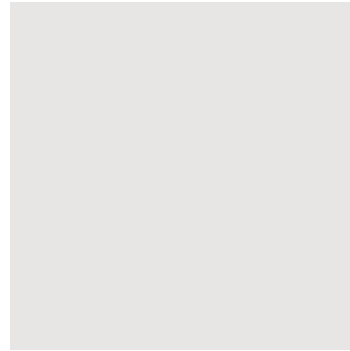
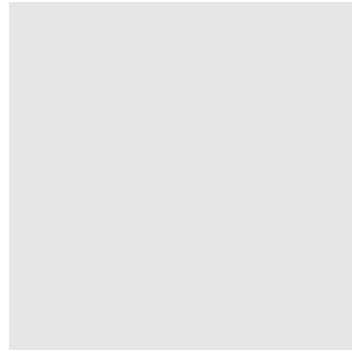
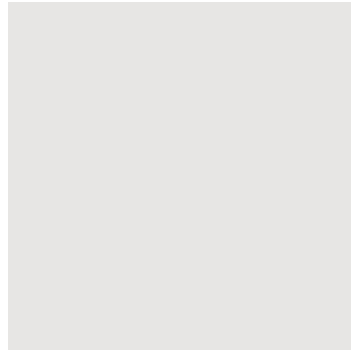
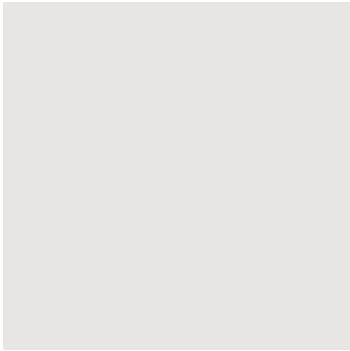
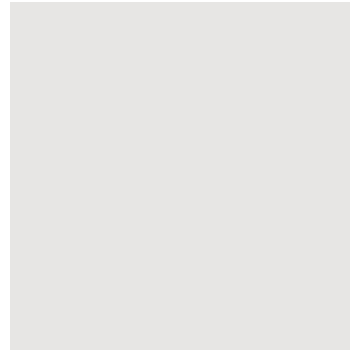
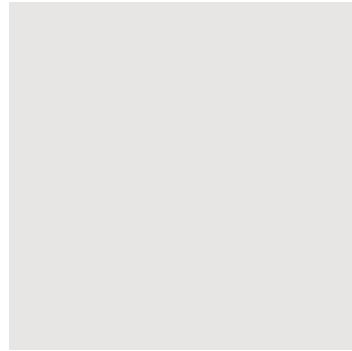
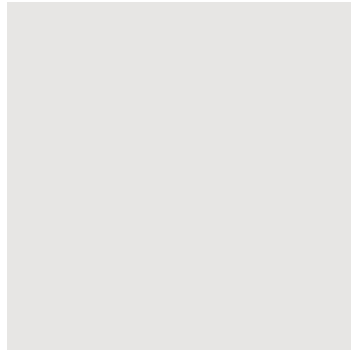
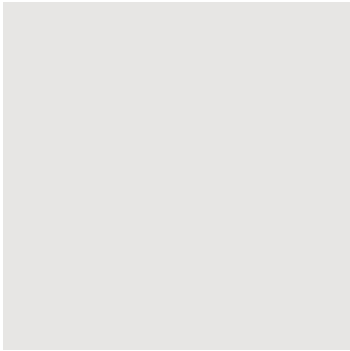
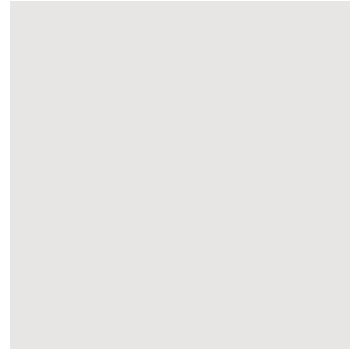
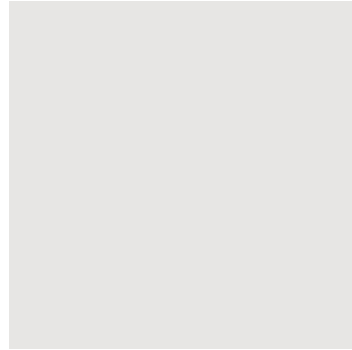
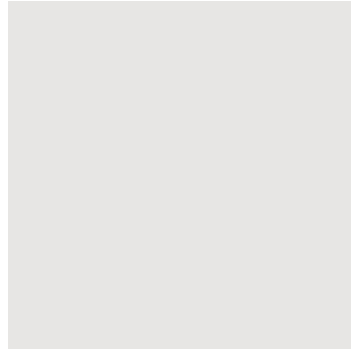
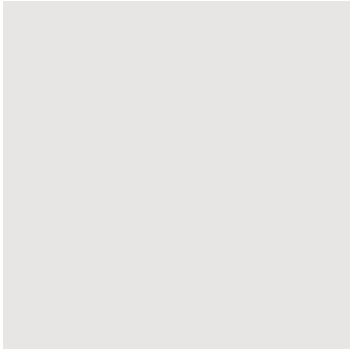
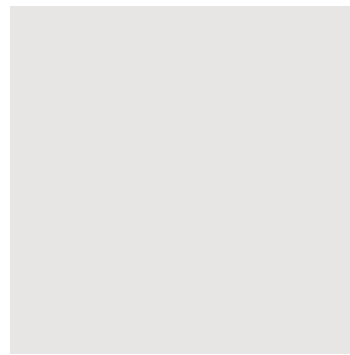
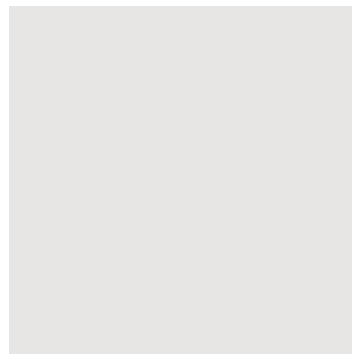
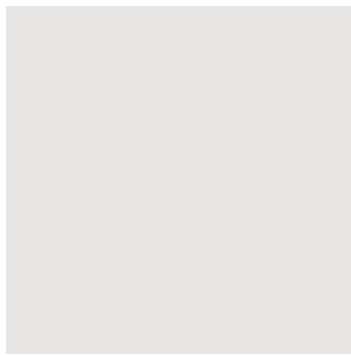





◆ RIGHT



ART.	◆	A	B
▲ 4CS.422.0000 .xx .x		220 (300)*	520 (600)*
🔧 4CS.22J.0000 .xx .x			
🔧 4CS.22Y.0000 .xx .x			
▲ 4CS.422.000M .xx .x		300 (380)*	520 (600)*
🔧 4CS.22J.000M .xx .x			
🔧 4CS.22Y.000M .xx .x			
▲ 4CS.422.000L .xx .x		320 (400)*	720 (800)*
🔧 4CS.22J.000L .xx .x			
🔧 4CS.22Y.000L .xx .x			
▲ 4CS.422.00LA .xx .x		400 (480)*	1160 (1240)*
🔧 4CS.22J.00LA .xx .x			
🔧 4CS.22Y.00LA .xx .x			
4CS.422.5075 .xx .x		500 (580)*	750 (830)*
🔧 4CS.22J.5075 .xx .x			
🔧 4CS.22Y.5075 .xx .x			
4CS.422.9999 .xx .x	⊙		⊙
🔧 4CS.22J.9999 .xx .x			
🔧 4CS.22Y.9999 .xx .x			

ART.	A	B
4CS.433.0000 .xx	1570 (1650)*	820 (900)*
🔧 4CS.33J.0000 .xx		
4CS.433.000L .xx	1570 (1650)*	1160 (1240)*
🔧 4CS.33J.000L .xx		
4CS.433.9999 .xx	⊙	⊙
🔧 4CS.33J.9999 .xx		

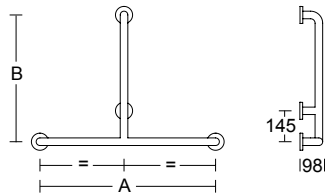
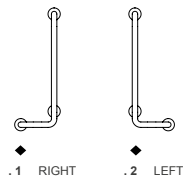
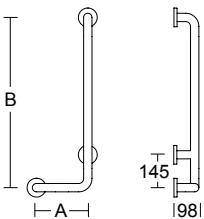

- Sostegno di sicurezza a "L"
- "L"-shaped safety support
- Barre d'appui forme à "L"
- Asidero en "L"



- Sostegno di sicurezza a "T"
- "T"-shaped safety support
- Barre d'appui forme à "T"
- Asidero en "T"



THESE PRODUCTS CONTRIBUTE TO LEED® CREDITS

XX FINISH	.44	SATINATO SATIN SATINE MATE	.43	LUCIDO BRIGHT POLI BRILLO
LVR	53		70	



- ◆
- .1 DESTRO RIGHT DROITE DERECHA
- .2 SINISTRO LEFT GAUCHE IZQUIERDA



◆ LEFT

ART.	◆	A	B	C
▲ 4CS.424.0000 .xx .x		660 (700)*	660 (700)*	820 (900)*
🔧 4CS.24J.0000 .xx .x				
▲ 4CS.424.000L .xx .x		760 (800)*	400 (440)*	1160 (1240)*
🔧 4CS.24J.000L .xx .x				
▲ 4CS.424.00LA .xx .x		760 (800)*	760 (800)*	1160 (1240)*
🔧 4CS.24J.00LA .xx .x				
4CS.424.9999 .xx .x	Ⓢ			
🔧 4CS.24J.9999 .xx .x				

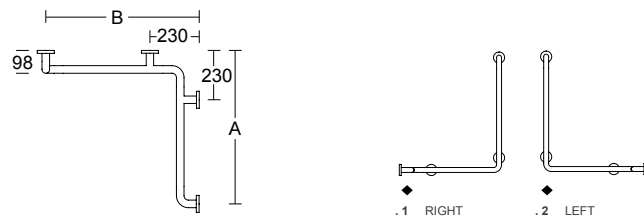
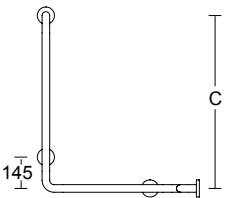

- Sostegno di sicurezza ad angolo con impugnatura verticale
- Corner safety support with shower head rail
- Barre d'appui à coin avec barre de douche
- Asidero en ángulo con empuñadura vertical



THESE PRODUCTS CONTRIBUTE TO LEED® CREDITS

.XX FINISH	.44	SATINATO SATIN SATINE MATE	.43	LUCIDO BRIGHT POLI BRILLO
LVR	53		70	



◆ LEFT

ART.	◆	A	B	C
▲ 4CS.443.000B .xx .x		760 (800)*	760 (800)*	1160 (1240)*
🔧 4CS.43J.000B .xx .x				
▲ 4CS.443.00BL .xx .x		760 (800)*	1185 (1225)*	1160 (1240)*
🔧 4CS.43J.00BL .xx .x				
4CS.443.00BM .xx .x		920 (960)*	920 (960)*	1160 (1240)*
🔧 4CS.43J.00BM .xx .x				
4CS.443.999B .xx .x	Ⓢ			
🔧 4CS.43J.999B .xx .x				

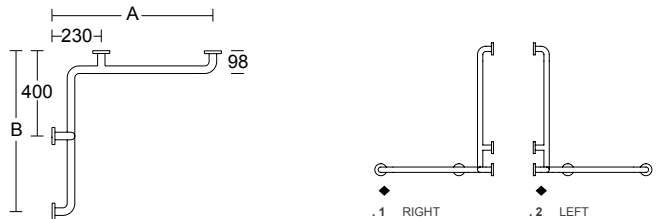
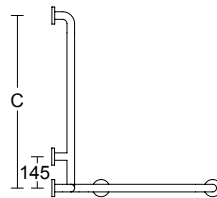

- Sostegno di sicurezza ad angolo con impugnatura verticale
- Corner safety support with shower head rail
- Barre d'appui à coin avec barre de douche
- Asidero en ángulo con empuñadura vertical



- ◆
- .1 DESTRO RIGHT DROITE DERECHA
- .2 SINISTRO LEFT GAUCHE IZQUIERDA



◆ LEFT

ART.	◆	A	B	C
▲ 4CS.443.0000 . xx . x		1160 (1200)*	760 (800)*	820 (900)*
▲ 4CS.43J.0000 . xx . x				
4CS.443.9999 . xx . x	Ⓢ			
4CS.43J.9999 . xx . x	Ⓢ			

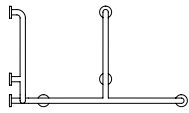
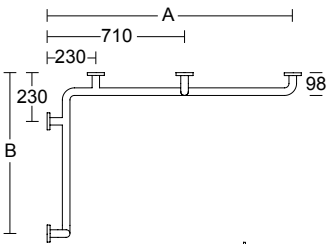
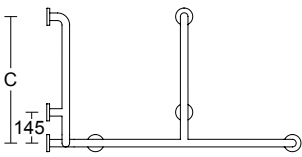

◆ .1 RIGHT

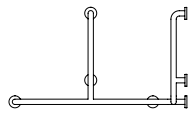

◆ .2 LEFT

- Sostegno di sicurezza ad angolo con due impugnature verticali
- Corner safety support with two shower head rails
- Barre d'appui à coin avec deux barres de douche
- Asidero en ángulo con dos empuñaduras verticales



THESE PRODUCTS CONTRIBUTE TO LEED® CREDITS

.XX FINISH	.44	SATINATO SATIN SATINE MATE	.43	LUCIDO BRIGHT POLI BRILLO
LVR	53		70	



ART.	A
▲ 4CS.487.0000 . xx	570 (650)*
▲ 4CS.487.000A . xx	770 (850)*
▲ 4CS.487.000B . xx	970 (1050)*
▲ 4CS.487.000C . xx	1170 (1250)*
4CS.487.9999 . xx	Ⓢ

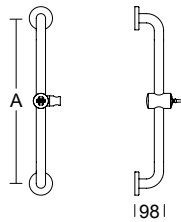

- Sostegno di sicurezza con reggisoffione
- Fixed safety support with shower head holder
- Barre d'appui fixe avec curseur de douchette
- Asidero con soporte para ducha regulable en altura



- ◆ .1 DESTRO RIGHT DROITE DERECHA
- ◆ .2 SINISTRO LEFT GAUCHE IZQUIERDA



ART.	A	B
4CS.487.00RD.17	140*	93*

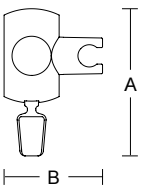
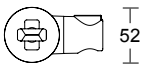

- Reggisoffione girevole con attacco conico universale a scorrimento compatibile con sostegni di sicurezza del PROGRAMMA 400-SS
- Rotating shower head holder with universal sliding tapered connection compatible with all safety supports of the PROGRAMMA 400-SS
- Curseur de douche rabatable avec élément de fixation mobile et conique universel compatible avec les barres d'appui du PROGRAMMA 400-SS
- Soporte ducha giratorio con base cónica universal deslizable compatible con todos los asideros del PROGRAMA 400-SS

THESE PRODUCTS CONTRIBUTE TO LEED® CREDITS

.XX FINISH	.44	SATINATO SATIN SATINE MATE	.43	LUCIDO BRIGHT POLI BRILLO
LVR	53		70	



ART.	A
▲ 4CS.440.0000 .xx	370 (450)*
▲ 4CS.440.000A .xx	570 (650)*
▲ 4CS.440.000B .xx	770 (850)*
▲ 4CS.440.000C .xx	970 (1050)*
▲ 4CS.440.000D .xx	1170 (1250)*
4CS.440.000Z .xx	300 (380)*
4CS.440.9999 .xx	Ⓢ

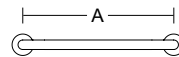

- Sostegno di sicurezza orizzontale
- Horizontal safety support
- Barre d'appui horizontale
- Asidero horizontal



.99 AMC TRANSPARENT SATIN

.99 AMC TRANSPARENT BRIGHT





ART.	A
▲ 4CS.423.000B .xx	1370 (1450)*
▲ 4CS.423.00BL .xx	1570 (1650)*
4CS.423.999B .xx	🌀

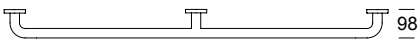
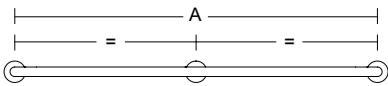

- Sostegno di sicurezza orizzontale con supporto intermedio
- Horizontal safety support with intermediate wall support
- Barre d'appui horizontale avec support intermédiaire
- Asidero horizontal con soporte intermedio



THESE PRODUCTS CONTRIBUTE TO LEED® CREDITS

.XX FINISH	.44	SATINATO SATIN SATINE MATE	.43	LUCIDO BRIGHT POLI BRILLO
LVR	53		70	



ART.	A
▲ 4CS.442.0000 .xx	760 (800)*
▲ 4CS.442.000M .xx	960 (1000)*
▲ 4CS.442.000L .xx	1160 (1200)*
4CS.442.9999 .xx	🌀

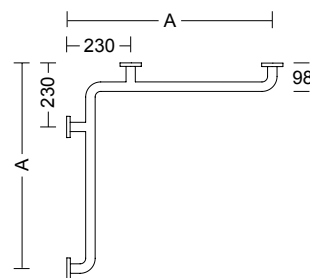
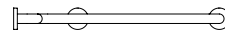

- Sostegno di sicurezza orizzontale con supporto intermedio
- Horizontal safety support with intermediate wall support
- Barre d'appui horizontale avec support intermédiaire
- Asidero horizontal con soporte intermedio





ART.	A	B
▲ 4CS.442.000B .xx	1060 (1100)*	560 (600)*
▲ 4CS.442.00BL .xx	1760 (1800)*	760 (800)*
4CS.442.999B .xx		

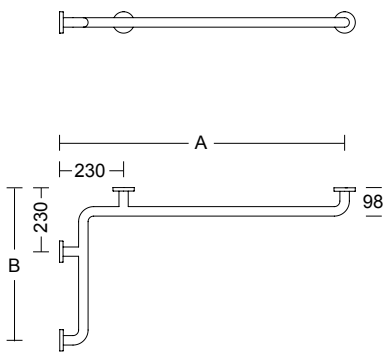

- Sostegno di sicurezza ad angolo asimmetrico
- Asymmetric corner safety support
- Barre d'appui à coin asymétrique
- Asidero en ángulo asimétrico



THESE PRODUCTS CONTRIBUTE TO LEED® CREDITS

.XX FINISH	.44	SATINATO SATIN SATINE MATE	.43	LUCIDO BRIGHT POLI BRILLO
LVR	53		70	



◆ LEFT

ART.	◆	A	B
4CS.427.0000 .xx . x		500	300
4CS.27Y.0000 .xx . x			

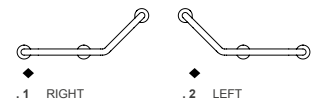
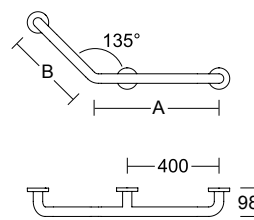

- Sostegno di sicurezza fisso aperto
- Open fixed safety support
- Barre d'appui fixe coudée
- Asidero fijo en ángulo



- ◆
- .1 DESTRO RIGHT DROITE DERECHA
- .2 SINISTRO LEFT GAUCHE IZQUIERDA



ART.	◆	A	B
4CS.427.00FC .xx . x		300	200
 4CS.27Y.00FC .xx . x			

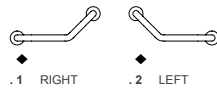
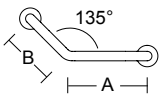

- Sostegno di sicurezza fisso aperto
- Open fixed safety support
- Barre d'appui fixe coudée
- Asidero fijo en ángulo



THESE PRODUCTS CONTRIBUTE TO LEED® CREDITS

.XX FINISH	.44	SATINATO SATIN SATINE MATE	.43	LUCIDO BRIGHT POLI BRILLO
LVR	53		70	



- ◆ .1 DESTRO RIGHT DROITE DERECHA
- .2 SINISTRO LEFT GAUCHE IZQUIERDA



ART.	A
▲ 4CS.441.000P .xx	600*
▲ 4CS.441.00PL .xx	700*
▲ 4CS.441.0PLL .xx	850*

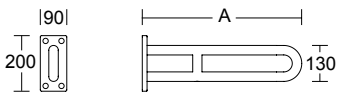

- Sostegno di sicurezza fisso su piastra
- Safety support fixed on plate
- Barre d'appui fixe sur plaque
- Asidero fijo sobre placa



THESE PRODUCTS CONTRIBUTE TO LEED® CREDITS

.XX FINISH	.44 SATINATO SATIN SATINE MATE	.43 LUCIDO BRIGHT POLI BRILLO
LVR	53	70



ART.	A
4CS.441.00PA .xx	600*
4CS.441.0PLA .xx	700*
4CS.441.PLLA .xx	850*

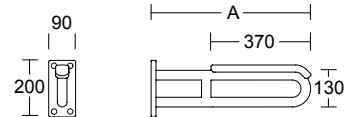

- Sostegno di sicurezza fisso su piastra con appoggiabraccio
- Safety support fixed on plate with armrest
- Barre d'appui fixe sur plaque avec accoudoir
- Asidero fijo sobre placa con apoyabrazos



.XX FINISH	.44 SATINATO SATIN SATINE MATE	.43 LUCIDO BRIGHT POLI BRILLO
LVR	53	70





ART.	A
▲ 4CS.445.000T .xx	600*
4CS.45Y.000T .xx	
4CS.45K.000T .xx	
▲ 4CS.445.0000 .xx	700*
4CS.45Y.0000 .xx	
4CS.45K.0000 .xx	
▶ ▲ 4CS.445.000L .xx	850*
4CS.45Y.000L .xx	
4CS.45K.000L .xx	

ART.	A
4CS.445.00TA .xx	600*
4CS.45Y.00TA .xx	
4CS.45K.00TA .xx	
4CS.445.000A .xx	700*
4CS.45Y.000A .xx	
4CS.45K.000A .xx	
▶ 4CS.445.00LA .xx	850*
4CS.45Y.00LA .xx	
4CS.45K.00LA .xx	

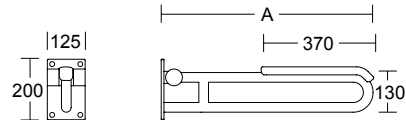
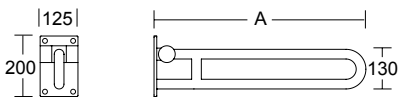

- Sostegno di sicurezza ribaltabile con frizione regolabile
- Lift-up safety support with friction device
- Barre d'appui relevable avec dispositif de friction
- Asidero abatible con embrague regulable



- Sostegno di sicurezza ribaltabile con frizione regolabile e appoggiabraccio
- Lift-up safety support with friction device and armrest
- Barre d'appui relevable avec dispositif de friction et accoudoir
- Asidero abatible con embrague regulable y apoyabrazos









THESE PRODUCTS CONTRIBUTE TO LEED® CREDITS

.XX FINISH	.44	SATINATO SATIN SATINE MATE	.43	LUCIDO BRIGHT POLI BRILLO
LVR	53		70	

.99 AMC TRANSPARENT SATIN

.99 AMC TRANSPARENT BRIGHT



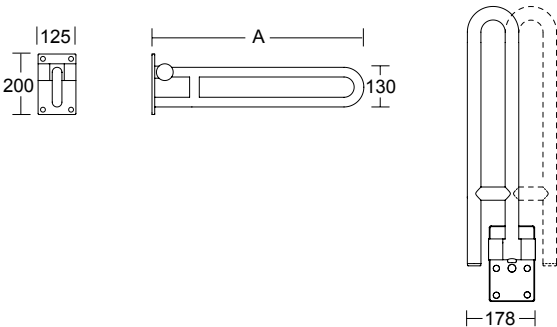

ART.	A
4CS.445.00GT .xx	600*
 4CS.45Y.00GT .xx	
 4CS.45K.00GT .xx	
4CS.445.000G .xx	700*
 4CS.45Y.000G .xx	
 4CS.45K.000G .xx	
▶ 4CS.445.00GL .xx	850*
 4CS.45Y.00GL .xx	
 4CS.45K.00GL .xx	



- Sostegno di sicurezza ribaltabile e girevole con frizione regolabile
- Rotating lift-up safety support with friction device
- Barre d'appui relevable et rabatable avec dispositif de friction
- Asidero abatible y giratorio con embrague regulable



ART.	A
4CS.445.00TE .xx	600*
 4CS.45Y.000E .xx	
4CS.445.00RE .xx	700*
 4CS.45Y.00RE .xx	
4CS.445.00LE .xx	850*
 4CS.45Y.00LE .xx	

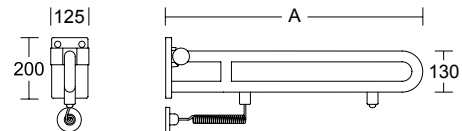

- Sostegno di sicurezza ribaltabile con frizione regolabile e comando elettrico
- Lift-up safety support with friction device and electrical push button
- Barre d'appui relevable avec dispositif de friction et bouton-poussoir électrique
- Asidero abatible con embrague regulable y botón eléctrico



THESE PRODUCTS CONTRIBUTE TO LEED® CREDITS

.XX FINISH	.44 SATINATO SATIN SATINE MATE	.43 LUCIDO BRIGHT POLI BRILLO
LVR	53	70



ART.	A
4CS.445.0TAE .xx	600*
4CS.45Y.0TAE .xx	
4CS.445.00AE .xx	700*
4CS.45Y.00AE .xx	
4CS.445.0LAE .xx	850*
4CS.45Y.0LAE .xx	

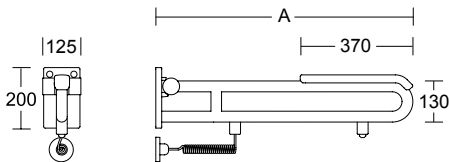

- Sostegno di sicurezza ribaltabile con frizione regolabile, appoggiabraccio e comando elettrico
- Lift-up safety support with friction device, armrest and electrical push button
- Barre d'appui relevable avec dispositif de friction, accouoir et bouton-poussoir électrique
- Asidero abatible con embrague regulable con apoyabrazos y botón eléctrico



THESE PRODUCTS CONTRIBUTE TO LEED® CREDITS

.XX FINISH	.44 SATINATO SATIN SATINE MATE	.43 LUCIDO BRIGHT POLI BRILLO
LVR	53	70



ART.	A	B	C
4CS.434.0000 .xx	490 (570)*	210*	200*

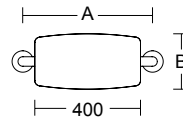

- Appoggiaschiena da WC
- WC backrest
- Appui dos pour WC
- Respaldo de WC





ART.	A	B	C
4CS.434.00RL .xx	655 (780)* - 795 (920)*	210*	152*

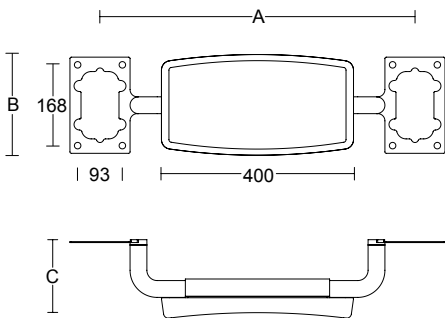

ART.	A	A1	A2
4CS.434.0RRL .xx.x	575 (728)* - 715 (828)*	247,5 - 317,5	327,5 - 397,5

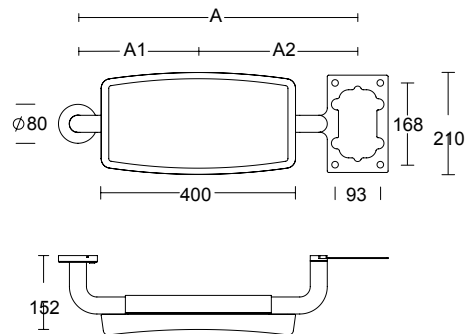

- Appoggiaschiena regolabile da fissare tra due sostegni di sicurezza ribaltabili 4CS.445.00XX CE
- WC Adjustable backrest to be fixed between two folding safety supports 4CS.445.00XX
- Appui dos réglable pour WC à fixer entre deux barres d'appui relevables 4CS.445.00XX
- Respaldo ajustable para montar entre dos asideros abatibles 4CS.445.00XX

THESE PRODUCTS CONTRIBUTE TO LEED® CREDITS

.XX FINISH	.44 SATINATO SATIN SATINE MATE	.43 LUCIDO BRIGHT POLI BRILLO
LVR	53	70

- Appoggiaschiena regolabile da fissare a sostegno di sicurezza ribaltabile 4CS.445.00XX e con rosetta a parete CE
- WC Adjustable backrest to be fixed on folding safety support 4CS.445.00XX and with wall fixing
- Appui dos réglable pour WC à fixer sur la barre d'appui relevable 4CS.445.00XX et avec fixation murale
- Respaldo ajustable para montar en asidero abatible 4CS.445.00XX y con fijación a pared



ART.	A
4CS.445.00CT . xx	613*
4CS.445.000C . xx	713*
▶ 4CS.445.00CL . xx	863*

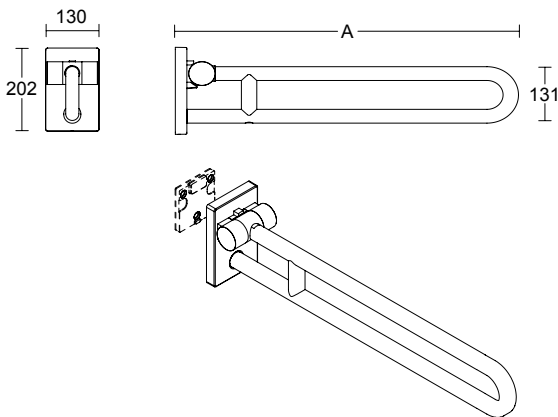

- Sostegno di sicurezza ribaltabile estraibile
- Extractable lift-up safety support
- Barre d'appui relevable amovibile
- Asidero abatible y extraíble



ART.	A
4CS.445.0CTA . xx	613*
4CS.445.00CA . xx	713*
4CS.445.0CLA . xx	863*

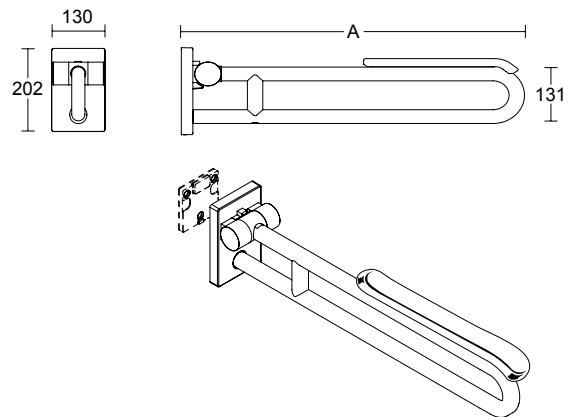

- Sostegno di sicurezza ribaltabile estraibile e appoggiabraccio
- Extractable lift-up safety support and armrest
- Barre d'appui relevable amovibile et accoudoir
- Asidero abatible y extraíble y apoyabrazos



THESE PRODUCTS CONTRIBUTE TO LEED® CREDITS

.XX FINISH	.44 SATINATO SATIN SATINE MATE	.43 LUCIDO BRIGHT POLI BRILLO
LVR	53	70

.99 AMC TRANSPARENT SATIN

.99 AMC TRANSPARENT BRIGHT



ART.
4CN.445.0CPM . 00

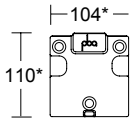

- Placca a muro per sostegno di sicurezza ribaltabile estraibile
- Wall plate for extractable lift-up safety support
- Plaque murale pour barre d'appui relevable amovible
- Placa en pared del asidero abatible y extraíble

THESE PRODUCTS CONTRIBUTE TO LEED® CREDITS



ART.
4CN.445.0CCP . 17

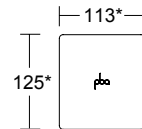

- Coperchio per placca a muro del sostegno di sicurezza ribaltabile estraibile
- Cover for wall plate of the extractable Lift-up safety support
- Couverture pour la plaque murale de la barre d'appui relevable amovible
- Tapa embellecedora para la placa en pared del asidero para baño abatible y extraíble



ART.
4CN.0RC.0000.00

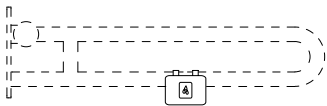

- Radiocomando per sistema elettronico di suono di emergenza e/o scarico dell'acqua WC
- Remote control for automatic WC-flushing system and/or emergency call
- Radiocommande pour système électronique d'évacuation de l'eau du WC et/ou appel d'urgence
- Control remoto electrónico para llamada de emergencia y/o la descarga de agua del WC



THESE PRODUCTS CONTRIBUTE TO LEED® CREDITS



ART.
4CN.0RC.002C.00

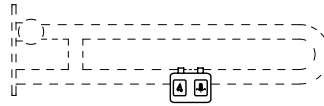

- Radiocomando per sistema elettronico di suono di emergenza e scarico dell'acqua WC
- Remote control for automatic WC-flushing system and emergency call
- Radiocommande pour système électronique d'évacuation de l'eau du WC et appel d'urgence
- Control remoto electrónico para llamada de emergencia y la descarga de agua del WC







ART.	A	B
4CS.447.000B .xx	380*	390*
4CS.47K.000B .xx		

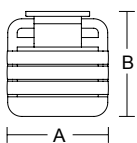
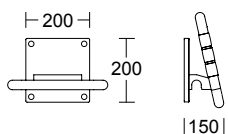

- Seggiolino ribaltabile
- Lift-up shower seat
- Siège relevable
- Asiento abatible



THESE PRODUCTS CONTRIBUTE TO LEED® CREDITS

.XX FINISH	.44	SATINATO SATIN SATINE MATE	.43	LUCIDO BRIGHT POLI BRILLO
LVR	53		70	



ART.	A	B	C
▲ 4CS.446.000B .xx	380*	485*	390*
▲ 4CS.446.00BL .xx	380*	485*	440*

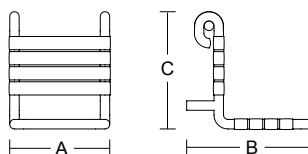

- Seggiolino da agganciare a sostegno di sicurezza
- Suspended seat
- Siège à suspendre
- Asiento suspendido





ART.	A	B	C
▲ 4CS.446.00BC .xx	445*	485*	390*
▲ 4CS.446.0BLC .xx	445*	485*	440*

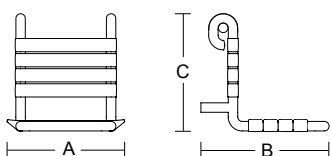

- Seggiolino da agganciare con seduta larga
- Large suspended seat
- Siège à suspendre large
- Asiento suspendido grande



THESE PRODUCTS CONTRIBUTE TO LEED® CREDITS

.XX FINISH	.44	SATINATO SATIN SATINE MATE	.43	LUCIDO BRIGHT POLI BRILLO
LVR	53		70	



ART.	A	B	C
4CS.449.000B .xx	380*	470*	430*

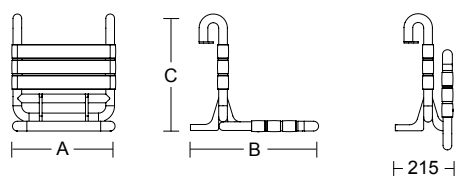



- Seggiolino agganciabile e ribaltabile
- Lift-up suspended seat
- Siège à suspendre et relevable
- Asiento suspendido y abatible



.XX FINISH	.44 SATINATO SATIN SATINE MATE	.43 LUCIDO BRIGHT POLI BRILLO
LVR	53	70





ART.	A	
4CS.429.0000 .xx	800*	8
4CS.429.000A .xx	900*	9
4CS.429.000B .xx	1000*	10
4CS.429.000C .xx	1100*	11
4CS.429.000D .xx	1200*	12
4CS.429.000E .xx	1300*	13
4CS.429.9999 .xx		

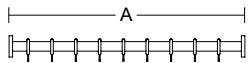

- Reggitenda dritto
- Straight shower curtain rail
- Barre de rideau de douche droit
- Barra de cortina de ducha recta



THESE PRODUCTS CONTRIBUTE TO LEED® CREDITS

.XX FINISH	.44	SATINATO SATIN SATINE MATE	.43	LUCIDO BRIGHT POLI BRILLO
LVR	53		70	



◆ RIGHT

ART.	◆	A	B
4CS.435.0000 .xx . x		800*	400*

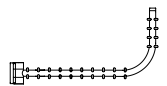
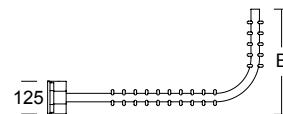
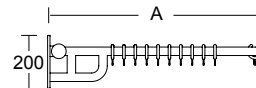

◆ .1 RIGHT

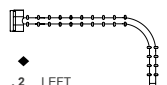

◆ .2 LEFT

- Reggitenda ribaltabile
- Lift-up shower curtain rail
- Barre de rideau de douche relevable
- Barra de cortina de ducha abatible

- ◆ .1 DESTRO RIGHT DROITE DERECHA
- ◆ .2 SINISTRO LEFT GAUCHE IZQUIERDA



ART.	A	B	
4CS.436.0000 .xx	800 (840)*	800 (840)*	16
4CS.436.9999 .xx			

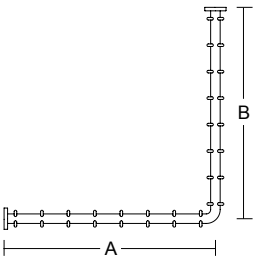
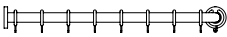



- Reggitenda angolare
- Corner shower curtain rail
- Barre de rideau de douche à coin
- Barra de cortina de ducha en ángulo

THESE PRODUCTS CONTRIBUTE TO LEED® CREDITS

.XX FINISH	.44	SATINATO SATIN SATINE MATE	.43	LUCIDO BRIGHT POLI BRILLO
LVR	53		70	





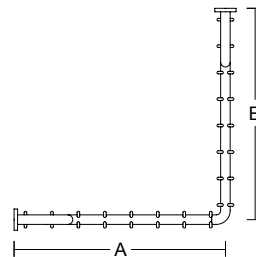
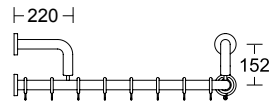

ART.	A	B	
4CS.436.00PP .xx	800 (840)*	800 (840)*	16
4CS.436.99PP .xx			



- Reggitenda angolare con due supporti a muro
- Corner shower curtain rail with two wall supports
- Barre de rideau de douche à coin avec deux supports murales
- Barra de cortina de ducha en ángulo con dos soportes en pared







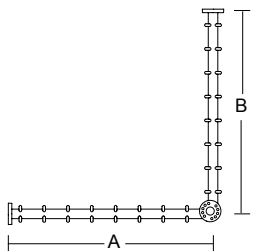
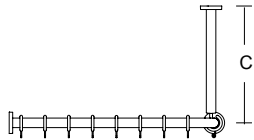

ART.	A	B	C	
4CS.436.000B .xx	800 (840)*	800 (840)*	440 (480)*	16
4CS.436.00BA .xx	900 (940)*	900 (940)*	440 (480)*	18
4CS.436.00BB .xx	1000 (1040)*	1000 (1040)*	440 (480)*	20
4CS.436.00BC .xx	1200 (1240)*	1200 (1240)*	440 (480)*	24
4CS.436.00BD .xx	1500 (1540)*	1500 (1540)*	440 (480)*	30
4CS.436.999B .xx				



- Reggitenda angolare con supporto a soffitto
- Corner shower curtain rail with ceiling support
- Barre de rideau de douche à coin avec support plafond
- Barra de cortina de ducha en ángulo con soporte de techo



ART.	A	B	C	
4CS.437.0000 .xx	800 (840)*	800 (880)*	440 (480)*	24
4CS.437.000A .xx	1000 (1040)*	1000 (1080)*	440 (480)*	30
4CS.437.9999 .xx				

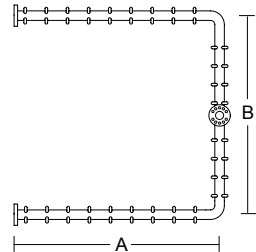
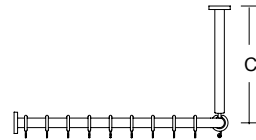

- Reggitenda su tre lati con supporto a soffitto
- Three-sided shower curtain rail with ceiling support
- Barre de rideau de douche sur trois côtés avec support plafond
- Barra de cortina de ducha en "U" con soporte de techo

THESE PRODUCTS CONTRIBUTE TO LEED® CREDITS

.XX FINISH	.44	SATINATO SATIN SATINE MATE	.43	LUCIDO BRIGHT POLI BRILLO
LVR	53		70	





ART.	L	H	
4CN.0SC.000A.01	1200	750	Art. 4CS.435.0000 .xx .x
4CN.0SC.000B.01	1200	2000	Art. 4CS.429.0000 .xx 4CS.429.000A .xx 4CS.429.000B .xx 4CS.436.0000 .xx * 4CS.436.00PP .xx * 4CS.436.000B .xx * 4CS.436.00BA .xx * 4CS.436.00BB .xx *
4CN.0SC.000C.01	1800	2000	Art. 4CS.429.000C .xx 4CS.429.000D .xx 4CS.429.000E .xx 4CS.436.00BC .xx * 4CS.436.00BD .xx * 4CS.437.0000 .xx * 4CS.437.000A .xx *

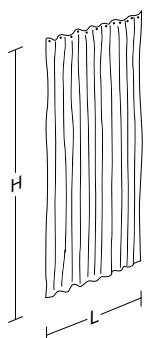

- Tenda ignifuga per doccia
- Fireproof shower curtain
- Rideau de douche ignifuge
- Cortina de ducha ignífuga

THESE PRODUCTS CONTRIBUTE TO LEED® CREDITS

* 2 PEZZI

* 2 PIECES



ART.	L	H	
4CN.0SC.00AE.01	1200	750	Art. 4CS.435.0000 .xx .x
4CN.0SC.00BE.01	1200	2000	Art. 4CS.429.0000 .xx 4CS.429.000A .xx
4CN.0SC.00FE.01	1500	2000	Art. 4CS.429.000B .xx 4CS.429.000C .xx 4CS.436.00BC .xx * 4CS.437.0000 .xx *
4CN.0SC.00CE.01	1800	2000	Art. 4CS.429.000D .xx 4CS.429.000E .xx 4CS.436.00BD .xx * 4CS.437.000A .xx *
4CN.0SC.00DE.01	2000	2000	Art. 4CS.436.0000 .xx 4CS.436.000B .xx 4CS.436.00PP .xx
4CN.0SC.00EE.01	2400	2000	Art. 4CS.436.00BA .xx 4CS.436.00BB .xx

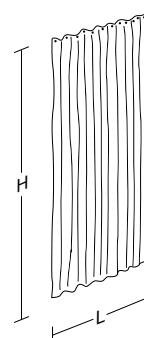

- Tenda impermeabile per doccia
- Waterproof shower curtain
- Rideau de douche imperméable
- Cortina de ducha impermeable

* 2 PIÈCES

* 2 PIEZAS



ART.	A	B	C	α
4CS.470.000D .xx	606	510	135	10°

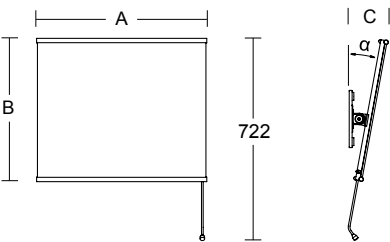

- Specchio orientabile con asta di movimento
- Adjustable mirror with control rod
- Miroir orientable avec bras de commande
- Espejo orientable con varilla movable



ART.	A	B	C	α
4CS.470.0000 .xx	605*	505*	155*	14°

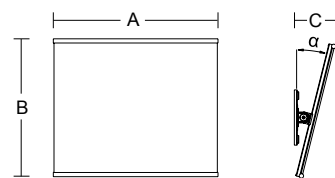

- Specchio orientabile con cornice
- Adjustable mirror with frame
- Miroir orientable avec cadre
- Espejo orientable con marco

THESE PRODUCTS CONTRIBUTE TO LEED® CREDITS

.XX FINISH	.44	SATINATO SATIN SATINE MATE	.43	LUCIDO BRIGHT POLI BRILLO
LVR	53		70	



ART.	A	B	C
4CS.490.000R .xx	600*	500	550*
4CS.490.00QR .xx	600*	650	700*
4CS.490.00AR .xx	600*	950	1000*

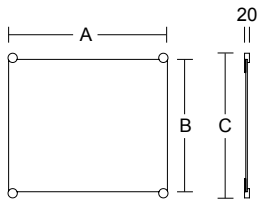

- Specchio fisso
- Fixed mirror
- Miroir fixe
- Espejo fijo



ART.	A	B
4CS.490.0WHR .xx	35	73



- Kit pinza reggispecchio per specchio fisso (4 pezzi)
- Kit mirror-holder supports for fixed mirror (4 pieces)
- Jeu supports porte-miroir pour miroir fixe (4 pièces)
- Juego pinza para anclar el espejo fijo (4 piezas)

THESE PRODUCTS CONTRIBUTE TO LEED® CREDITS

.XX FINISH	.44 SATINATO SATIN SATINE MATE	.43 LUCIDO BRIGHT POLI BRILLO
LVR	53	70



ART.	A	B
4CS.407.00TU.17	405*	84*

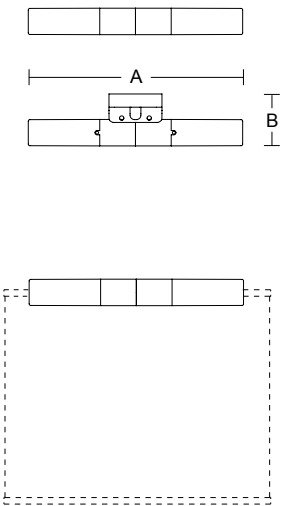

- Lampada da applicare su specchi orientabili.
IP 54 con Art. 4CN.0IP.0068.00
- Lamp for adjustable mirrors.
IP 54 with Art. 4CN.0IP.0068.00
- Lampe pour miroirs orientables
IP 54 avec Art. 4CN.0IP.0068.00
- Aplique para espejos orientables.
IP 54 con Art. 4CN.0IP.0068.00

CE
IP 54

THESE PRODUCTS CONTRIBUTE TO LEED® CREDITS



ART.	A	B
4CS.407.0TUR.17	405*	77*

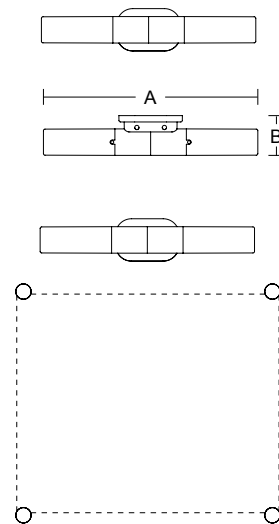

- Lampada da fissare a parete.
IP 54 con Art. 4CN.0IP.0068.00
- Wall lamp for mirror.
IP 54 with Art. 4CN.0IP.0068.00
- Lampe de mur pour miroir.
IP 54 avec Art. 4CN.0IP.0068.00
- Aplique con fijación en pared.
IP 54 con Art. 4CN.0IP.0068.00

CE
IP 54



ART.	A	B	C
4CS.492.0000 .xx	240*	126*	46*

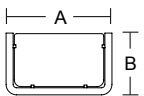

- Mensola portaoggetti
- Bathroom shelf
- Tablette porte-objet
- Estante porta-objetos



ART.	A	B	C
4CS.492.000B.17	210*	120*	110*

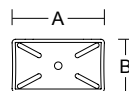
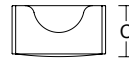

- Mensola applicabile su supporto orizzontale
- Bathroom shelf to be integrated to horizontal support
- Tablette accrochable à la barre d'appui horizontale
- Estante aplicable a asidero horizontal

THESE PRODUCTS CONTRIBUTE TO LEED® CREDITS

.XX FINISH	.44	SATINATO SATIN SATINE MATE	.43	LUCIDO BRIGHT POLI BRILLO
LVR	53		70	



ART.	A	B	C
4CS.493.0000 .xx	204*	204*	16*

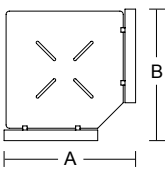
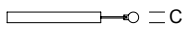

- Mensola ad angolo
- Corner shelf
- Tablette à coin
- Estante en ángulo



ART.	A	B
4CS.485.00IN .xx	638*	126*

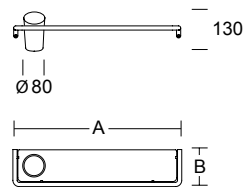

- Mensola con bicchiere conico
- Shelf with conical tumbler
- Tablette avec gobelet conique
- Estante con vaso cónico

THESE PRODUCTS CONTRIBUTE TO LEED® CREDITS

.XX FINISH	.44	SATINATO SATIN SATINE MATE	.43	LUCIDO BRIGHT POLI BRILLO
LVR	53		70	



ART.	A	B	C
4CS.484.0000 .xx	638*	126*	46*

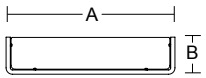

- Mensola
- Shelf
- Tablette
- Estante



ART.	A	B	C
4CS.483.000N .xx	160*	126*	50*

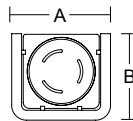

- Mensola con portasapone
- Shelf with soap dish
- Tablette avec porte-savon
- Estante con jabonera

THESE PRODUCTS CONTRIBUTE TO LEED® CREDITS

.XX FINISH	.44	SATINATO SATIN SATINE MATE	.43	LUCIDO BRIGHT POLI BRILLO
LVR	53		70	



ART.	A	B
4CS.483.0IBN .xx	160*	126*

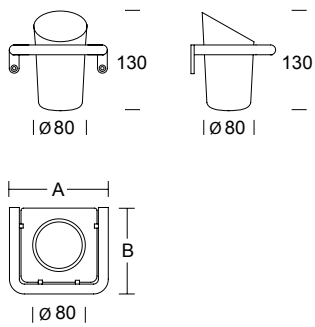

- Mensola con bicchiere conico
- Shelf with conical tumbler
- Tablette avec gobelet conique
- Estante con vaso cónico



ART.	A	B	C
4CS.456.0000 .xx	160*	126*	190*

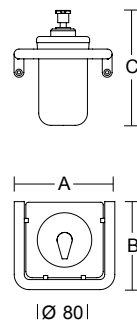

- Mensola con dispenser sapone (lt. 0,4)
- Shelf with soap dispenser (lt. 0,4)
- Tablette avec distributeur de savon (lt. 0,4)
- Estante con dispensador de jabón (lt 0,4)

THESE PRODUCTS CONTRIBUTE TO LEED® CREDITS

.XX FINISH	.44 SATINATO SATIN SATINE MATE	.43 LUCIDO BRIGHT POLI BRILLO
LVR	53	70



ART.	A	B	C
4CS.498.0000.44	120	265*	320*

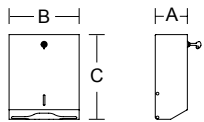

- Portasalvietta
- Paper towel dispenser
- Distributeur d'essuie-mains papier
- Dispensador de papel toallas

THESE PRODUCTS CONTRIBUTE TO LEED® CREDITS



ART.	A	B
4CN.457.0000.17	145	105

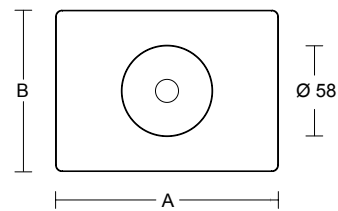

- Dispenser sacchetti igienici da parete o da appoggio
- Hygienic bag dispenser to be installed on the wall or on a stand
- Distributeur de sacs hygiéniques pour montage murale ou pose sur une surface
- Dispensador de bolsas higiénicas para montar en pared o para apoyar



ART.	A	B
4CS.481.0000 .xx	167*	110*

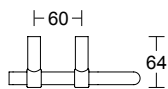
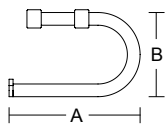

- Portarotolo a muro
- Wall toilet roll holder
- Porte-papier murale
- Portarrollo de pared



ART.	A	B
4CS.481.000Q .xx	179*	111*

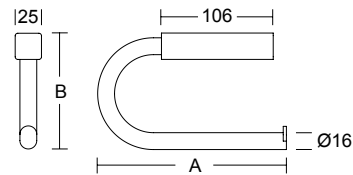

- Portarotolo a muro
- Wall toilet roll holder
- Porte-papier murale
- Portarrollo de pared

THESE PRODUCTS CONTRIBUTE TO LEED® CREDITS

.XX FINISH	.44 SATINATO SATIN SATINE MATE	.43 LUCIDO BRIGHT POLI BRILLO
LVR	53	70



ART. A B
 4CS.481.0QRL . xx 279* 111*

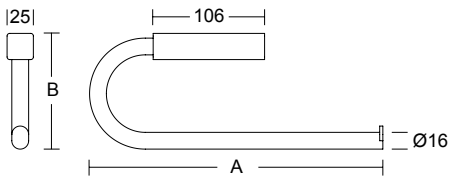

- Portarotolo a muro
- Wall toilet roll holder
- Porte-papier murale
- Portarrollo de pared

THESE PRODUCTS CONTRIBUTE TO LEED® CREDITS

.XX FINISH	.44 SATINATO SATIN SATINE MATE	.43 LUCIDO BRIGHT POLI BRILLO
LVR	53	70



ART.
 4CS.482.00RU . xx

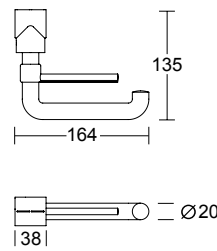

- Portarotolo con supporto in acciaio inox 316L per rapida applicazione in cantiere senza foratura dell'ausilio
- Toilet roll holder with stainless steel AISI 316L hook for quick mounting on site without drill holes
- Porte-papier avec crochet en acier inox AISI 316L pour assemblage rapide sur place sans percer la barre
- Portarrollo con soporte de acero inoxidable AISI 316L para montaje rápido en obra sin taladrar el asidero



ART.	A	B
4CS.481.00RL .xx	64*	255*



ART.	A	B
4CS.481.000R .xx	130*	Ø 80

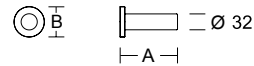
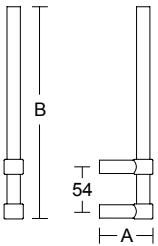

- Portarotolo di riserva
- Spare toilet roll holder
- Porte-papier de réserve
- Portarrollo de reserva

- Portarotolo di riserva
- Spare toilet roll holder
- Porte-papier de réserve
- Portarrollo de reserva

THESE PRODUCTS CONTRIBUTE TO LEED® CREDITS

.XX FINISH	.44	SATINATO SATIN SATINE MATE	.43	LUCIDO BRIGHT POLI BRILLO
LVR	53		70	



ART.	A	B
4CS.486.000H .xx	510*	Ø 80

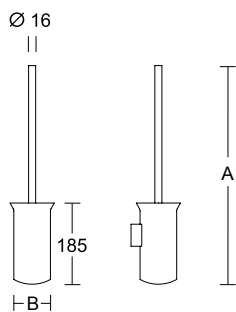

- Portascopino ad imbocco conico con impugnatura in acciaio
- Conical toilet brush set with steel handle
- Ensemble brosse WC conique avec manche en acier
- Escobillero cónico con con mango de acero inoxidable



ART.	A	B
4CS.486.0000 .xx	520*	Ø 80

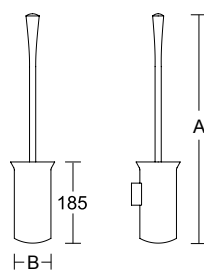

- Portascopino ad imbocco conico con impugnatura in nylon
- Conical toilet brush set with nylon handle
- Ensemble brosse WC conique avec manche en nylon
- Escobillero cónico con con mango de nylon

THESE PRODUCTS CONTRIBUTE TO LEED® CREDITS

.XX FINISH	.44 SATINATO SATIN SATINE MATE	.43 LUCIDO BRIGHT POLI BRILLO
LVR	53	70



ART.
4CS.011.0000 . xx

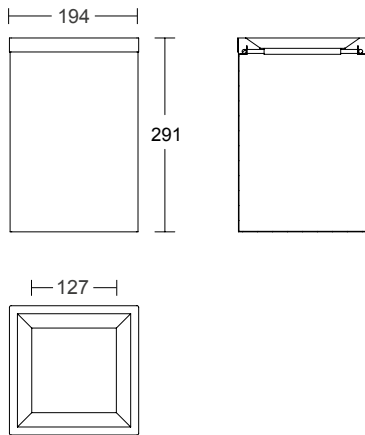

- Cestino (lt. 8)
- Waste bin (lt. 8)
- Poubelle (lt. 8)
- Papelera (lt. 8)



ART.
4CS.012.0000 . xx

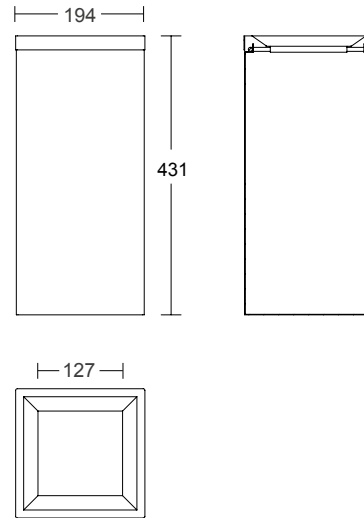

- Cestino (lt. 12)
- Waste bin (lt. 12)
- Poubelle (lt. 12)
- Papelera (lt. 12)

THESE PRODUCTS CONTRIBUTE TO LEED® CREDITS

.XX FINISH	.44 SATINATO SATIN SATINE MATE	.43 LUCIDO BRIGHT POLI BRILLO
	LVR 53	70



ART.	A	B	C
4CN.497.0000.10	220*	205*	365*

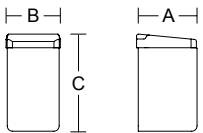

- Cestino da parete con apertura a spinta (lt. 12) Colore ●
- Wall waste bin push-to-open mechanism (lt. 12) Colour ●
- Poubelle murale ouverture par pression (lt. 12) Couleur ●
- Papelera de pared apertura a presión (lt. 12) Color ●

THESE PRODUCTS CONTRIBUTE TO LEED® CREDITS



ART.	A	B
4CS.489.0000 .xx	400 (450)*	90*
4CS.489.000A .xx	500 (550)*	90*
4CS.489.000B .xx	600 (650)*	90*

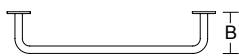
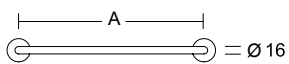

- Portasciugamani
- Towel holder
- Porte-serviette
- Toallero



ART.	A	B
4CS.426.0000 .xx	500*	106

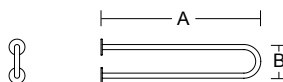

- Portasciugamani
- Towel holder
- Porte-serviette
- Toallero

THESE PRODUCTS CONTRIBUTE TO LEED® CREDITS

.XX FINISH	.44	SATINATO SATIN SATINE MATE	.43	LUCIDO BRIGHT POLI BRILLO
LVR	53		70	



ART.	A	B
4CS.488.000D .xx	Ø 50	40*



- Gancio appendiabiti doppio
- Double cloth hook
- Patère double
- Percha doble



ART.	A	B
4CS.488.0000 .xx	Ø 50	40*



- Gancio appendiabiti
- Cloth hook
- Patère
- Percha

THESE PRODUCTS CONTRIBUTE TO LEED® CREDITS

.XX FINISH	.44 SATINATO SATIN SATINE MATE	.43 LUCIDO BRIGHT POLI BRILLO
LVR	53	70



ART.	A	B
4CS.488.000C .xx	Ø 50	63*

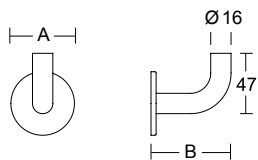

- Gancio appendiabiti
- Cloth hook
- Patère
- Percha



ART.	A	B
5CS.562.0000 .xx	Ø 50	76*

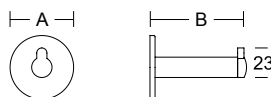

- Appendiabiti fermaporta
- Door-stop cloth hook
- Patère-butoir
- Tope-percha

THESE PRODUCTS CONTRIBUTE TO LEED® CREDITS

.XX FINISH	.44 SATINATO SATIN SATINE MATE	.43 LUCIDO BRIGHT POLI BRILLO
LVR	53	70



ART.	A	B
2MM.402.000U .xx	150*	150*

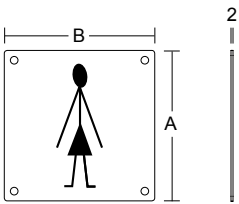

ART.	A	B
2MM.402.0000 .xx	150*	150*

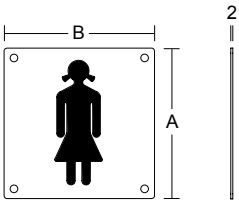

- Pittogramma donna
- Lady pictogram
- Pictogramme femme
- Pictograma mujer



ART.	A	B
2MM.401.000U .xx	150*	150*

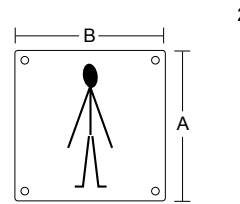

ART.	A	B
2MM.401.0000 .xx	150*	150*

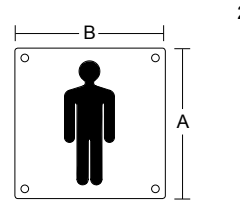

- Pittogramma uomo
- Man pictogram
- Pictogramme homme
- Pictograma hombre

THESE PRODUCTS CONTRIBUTE TO LEED® CREDITS

.XX FINISH	.44 SATINATO SATIN SATINE MATE	.43 LUCIDO BRIGHT POLI BRILLO
LVR	53	70



ART.	A	B
2MM.404.000U .xx	150*	150*

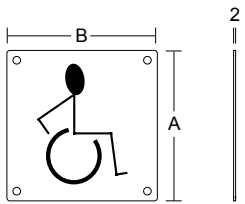

ART.	A	B
2MM.404.0000 .xx	150*	150*

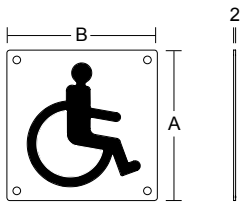

- Pittogramma disabile
- Disabled pictogram
- Pictogramme handicapé
- Pictograma minusválido

THESE PRODUCTS CONTRIBUTE TO LEED® CREDITS

.XX FINISH	.44 SATINATO SATIN SATINE MATE	.43 LUCIDO BRIGHT POLI BRILLO
LVR	53	70



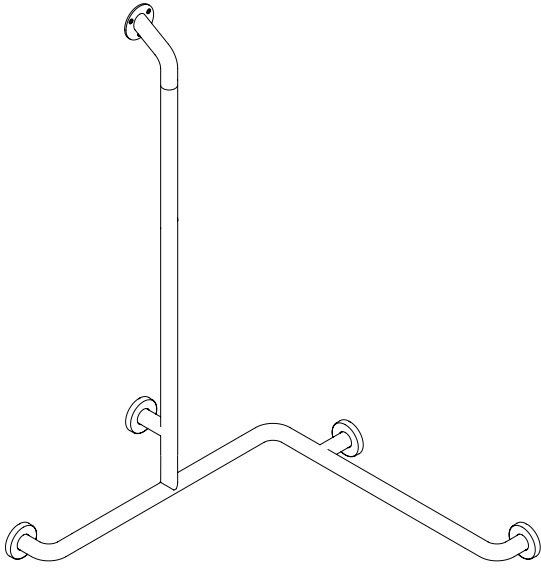

◆ LEFT

ART.	◆	A	B	C
4CS.443.0ASB . xx . x		760 (800)*	760 (800)*	1160 (1240)*
4CS.43J.0ASB . xx . x				
4CS.443.ASBL . xx . x		760 (800)*	1185 (1225)*	1160 (1240)*
4CS.43J.ASBL . xx . x				
4CS.443.9ASB . xx . x	Ⓢ			
4CS.43J.9ASB . xx . x				

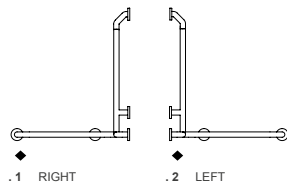
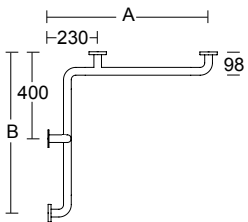
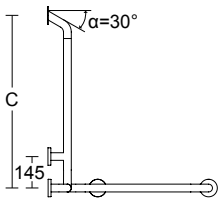

- Sostegno di sicurezza ad angolo con curva inclinata e impugnatura verticale
- Corner safety support with inclined bend and shower head rail
- Barre d'appui à coin avec coude inclinée et barre de douche
- Asidero en ángulo con codo inclinada con empuñadura vertical

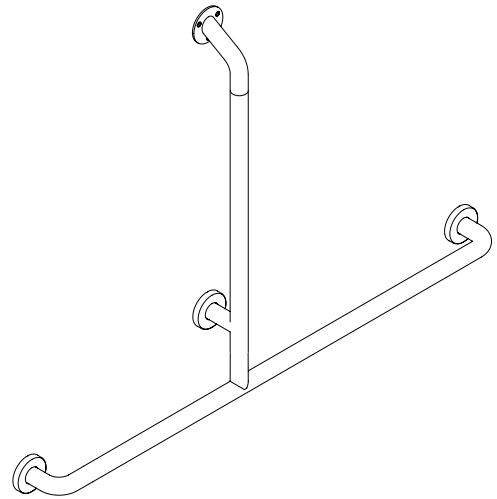

ART.	A	B
4CS.433.00AS . xx	1570 (1650)*	820 (900)*
4CS.33J.00AS . xx		
4CS.433.99AS . xx	Ⓢ	Ⓢ
4CS.33J.99AS . xx		

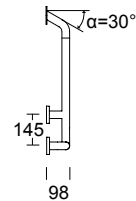
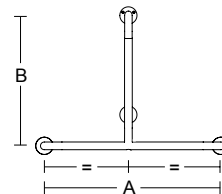

- Sostegno di sicurezza a "T" con curva inclinata
- "T"-shaped safety support inclined bend
- Barre d'appui forme à "T" avec coude inclinée
- Asidero en "T" con codo inclinado



THESE PRODUCTS CONTRIBUTE TO LEED® CREDITS

XX FINISH	.44	SATINATO SATIN SATINE MATE	.43	LUCIDO BRIGHT POLI BRILLO
LVR	53		70	

- ◆
- .1 DESTRO RIGHT DROITE DERECHA
- .2 SINISTRO LEFT GAUCHE IZQUIERDA

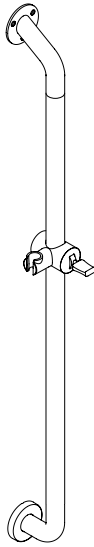

ART.	A
4CS.487.0ASC .xx	1170 (1250)*
4CS.487.99AS .xx	

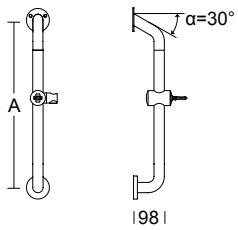

198 |



- Sostegno di sicurezza con reggisoffione con curva inclinata
- Fixed safety support inclined bend and with shower head holder
- Barre d'appui fixe avec curseur de douchette avec coude inclinée
- Asidero con soporte para ducha regulable en altura con codo inclinado

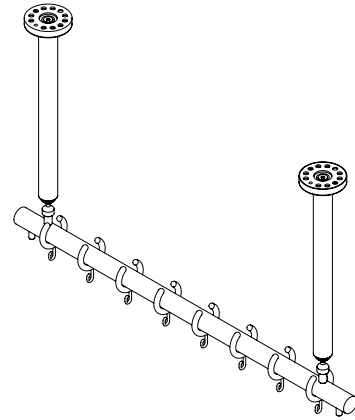

THESE PRODUCTS CONTRIBUTE TO LEED® CREDITS

.XX FINISH	.44	SATINATO SATIN SATINE MATE	.43	LUCIDO BRIGHT POLI BRILLO
LVR	53		70	



ART.	A	
4CS.429.00AS .xx	800*	8
4CS.429.0ASA .xx	900*	9
4CS.429.0ASB .xx	1000*	10
4CS.429.0ASC .xx	1100*	11
4CS.429.0ASD .xx	1200*	12
4CS.429.0ASE .xx	1300*	13
4CS.429.99AS .xx		

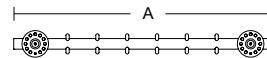
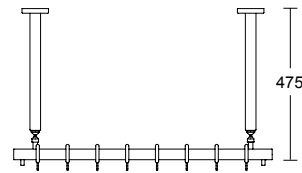

- Reggitenda dritto con 2 supporti a soffitto con dispositivo di sgancio meccanico anti-suicidio
- Straight shower curtain rail with 2 ceiling supports with anti-suicide release system
- Barre de rideau de douche droit avec 2 supports plafond avec système de décrochage mécanique anti-suicide
- Barra de cortina de ducha recta con 2 soportes de techo con dispositivo de desenganche mecánico anti-suicidio

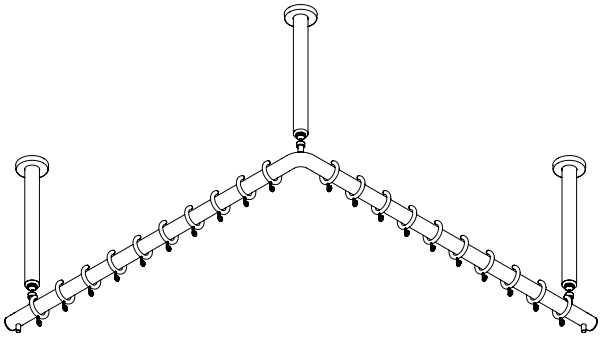

ART.	A	B	C	⊙
4CS.436.0ASB .xx	800 (840)*	800 (840)*	440 (475)*	16
4CS.436.ASBA .xx	900 (940)*	900 (940)*	440 (475)*	18
4CS.436.ASBB .xx	1000 (1040)*	1000 (1040)*	440 (475)*	20
4CS.436.ASBC .xx	1200 (1240)*	1200 (1240)*	440 (475)*	24
4CS.436.ASBD .xx	1500 (1540)*	1500 (1540)*	440 (475)*	30
4CS.436.9ASB .xx	Ⓢ	Ⓢ	Ⓢ	

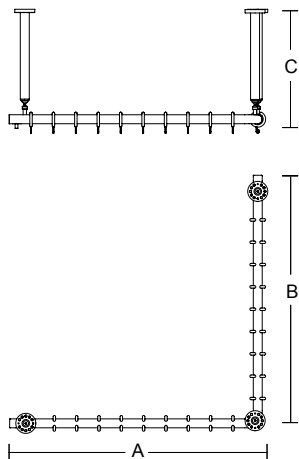

- Reggitemda angolare con 3 supporti a soffitto con dispositivo di sgancio meccanico anti-suicidio
- Corner shower curtain rail with 3 ceiling supports with anti-suicide release system
- Barre de rideau de douche à coin avec 3 supports plafond avec système de décrochage mécanique anti-suicide
- Barra de cortina de ducha en ángulo con tres soportes de techo con dispositivo de desenganche mecánico anti-suicidio

THESE PRODUCTS CONTRIBUTE TO LEED® CREDITS

.XX FINISH	.44	SATINATO SATIN SATINE MATE	.43	LUCIDO BRIGHT POLI BRILLO
LVR	53		70	

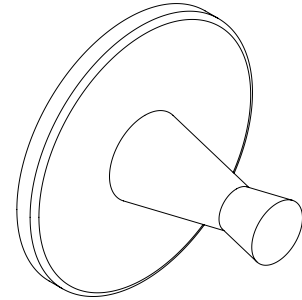

ART.	A	B
4CS.488.0ASP .xx	∅ 50	34*

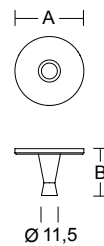

- Gancio appendiabiti
- Cloth hook
- Patère
- Percha



ART. A
4CS.486.00HR.44 480

- Scopino di riserva con impugnatura in acciaio
- Spare toilet brush with steel handle
- Brosse WC de réserve avec manche en acier
- Escobilla de reserva con mango de acero inoxidable



ART. A
4CS.486.00CR.17 480

- Scopino di riserva con impugnatura in nylon
- Spare toilet brush with nylon handle
- Brosse WC de réserve avec manche en nylon
- Escobilla de reserva con mango de nylon

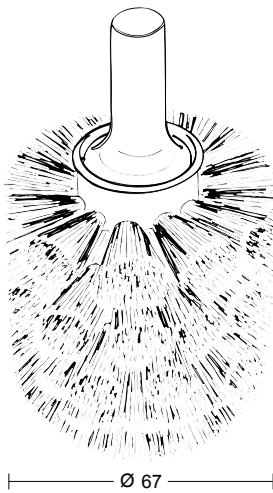

ART.
4CS.486.000B.00

- Scopino di riserva
- Spare toilet brush head
- Tête brosse WC de réserve
- Cabezal de escobilla de reserva para escobillero

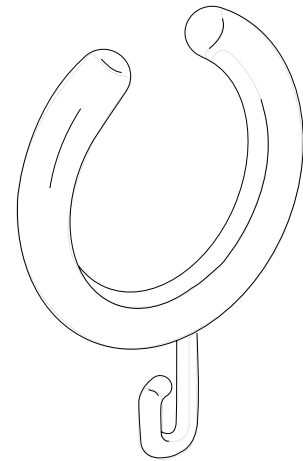

ART.
4CS.0AN.0003.17

- Anello reggitenda
- Shower curtain ring
- Anneau pour rideau de douche
- Anillas para cortina

THESE PRODUCTS CONTRIBUTE TO LEED® CREDITS

.XX FINISH .44 SATINATO
SATIN
SATINE
MATE

LVR 53

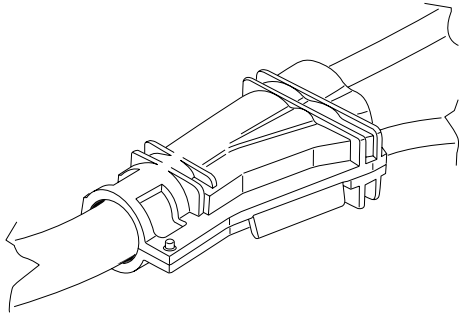

ART.
4CN.0IP.0068.00

- Giunzione rapida per cavi elettrici
- Quick junction for electric cables
- Jonction rapide pour cables électriques
- Kit conector para cables eléctricos

CE
IP 68

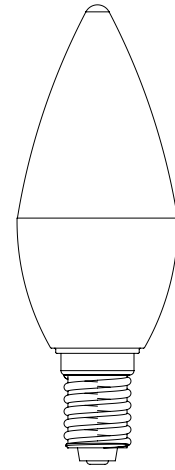

ART.
4CN.407.00LT.00

- Lampadina LED di classe energetica A+
- Light LED bulb energy class A+
- Ampoule LED de classe énergétique A+
- Bombilla LED de eficiencia energética A+

CE

THESE PRODUCTS CONTRIBUTE TO LEED® CREDITS

PROGRAMMA PBA WF

PATENT PENDING ITALY 102019000013932
PATENT DEUTCHLAND 202020104488.5

PBA
PATENTED
SYSTEM

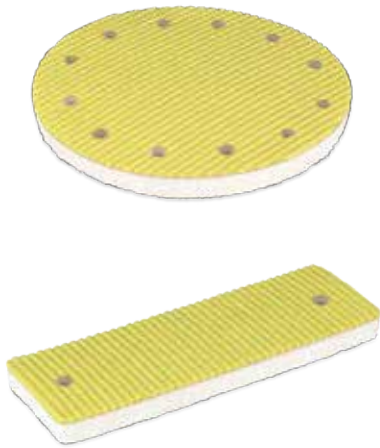

ART.
4CN.0VM.WF44.00
4CN.0VM.WF46.00

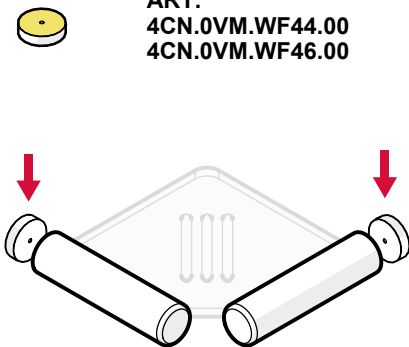

Bathroom shelf 400-NY and 400-SS



ART.
4CN.0VM.WF40.00

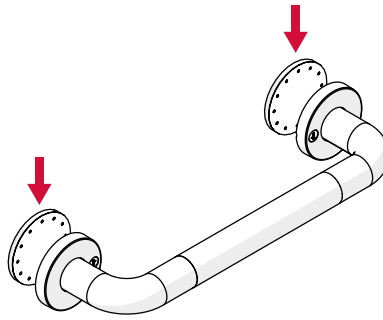

Articles with fixing rose



ART.
4CN.0VM.WF45.00

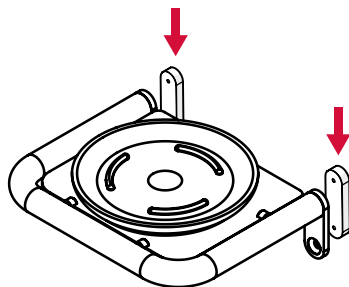

Bathroom shelf 400-SS



ART.
4CN.0VM.WF41.00

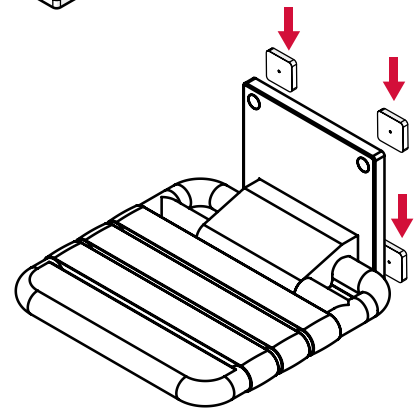

Shower seat with plate and lift-up support

HAND SANITIZER COVER





pba PER LA CERTIFICAZIONE LEED®

LEED® (LEADERSHIP IN ENERGY ENVIRONMENTAL DESIGN) È UN SISTEMA DI CERTIFICAZIONE A BASE VOLONTARIA PER LA GESTIONE, LA PROGETTAZIONE E LA COSTRUZIONE DI EDIFICI SOSTENIBILI DAL PUNTO DI VISTA SOCIALE, AMBIENTALE, ECONOMICO E DEL BENESSERE PER GLI UTILIZZATORI.



I PRODOTTI pba CONTRIBUISCONO AI PREREQUISITI E AI CREDITI LEED®.

PROCESSO INTEGRATO	IP	
MATERIALI E RISORSE	MR	
QUALITÀ DELL'AMBIENTE INTERNO	EQ	
INNOVAZIONE	I	

pba FOR LEED® CERTIFICATION

LEED® (LEADERSHIP IN ENERGY ENVIRONMENTAL DESIGN) IS A VOLUNTARY CERTIFICATION SYSTEM FOR THE MANAGEMENT, DESIGN AND CONSTRUCTION OF BUILDINGS THAT ARE SUSTAINABLE FROM A SOCIAL, ENVIRONMENTAL AND ECONOMIC POINT OF VIEW AND IN TERMS OF THE WELLBEING OF THE USERS.





pba PRODUCTS CONTRIBUTE TOWARD SATISFYING PREREQUISITES AND CREDITS UNDER LEED®.

INTEGRATED PROCESS	IP	
MATERIALS AND RESOURCES	MR	
INDOOR ENVIRONMENTAL QUALITY	EQ	
INNOVATION	I	

pba POUR LA CERTIFICATION LEED®

LEED® (LEADERSHIP IN ENERGY ENVIRONMENTAL DESIGN) EST UN SYSTÈME DE CERTIFICATION À BASE VOLONTAIRE POUR LA GESTION, LA CONCEPTION ET LA CONSTRUCTION DE BÂTIMENTS DURABLES D'UN POINT DE VUE SOCIAL, ENVIRONNEMENTAL, ÉCONOMIQUE ET DU BIEN-ÊTRE POUR LES UTILISATEURS.

LES PRODUITS pba CONTRIBUENT AUX CONDITIONS PRÉALABLES REQUISES ET AUX CRÉDITS LEED®.

PROCESSUS DE CONCEPTION INTÉGRÉE	IP	
MATÉRIAUX ET RESSOURCES	MR	
QUALITÉ DES ENVIRONNEMENTS INTÉRIEURS	EQ	
INNOVATION	I	

pba PARA LA CERTIFICACIÓN LEED®

LEED® (LEADERSHIP IN ENERGY ENVIRONMENTAL DESIGN) ES UN SISTEMA DE CERTIFICACIÓN DE BASE VOLUNTARIA PARA LA GESTIÓN, EL DISEÑO Y LA CONSTRUCCIÓN DE EDIFICIOS SOSTENIBLES DESDE EL PUNTO DE VISTA SOCIAL, MEDIOAMBIENTAL, ECONÓMICO Y DEL BIENESTAR PARA LOS USUARIOS.

LOS PRODUCTOS pba CONTRIBUYEN EN LOS PRE-REQUISITOS Y EN LOS CRÉDITOS LEED®.

PROCESO INTEGRADO	IP	
MATERIALES Y RECURSOS	MR	
CALIDAD DEL AMBIENTE INTERNO	EQ	
INNOVACIÓN	I	

CHART OF PBA PRODUCTS CONTRIBUTION TO LEED V4

INTEGRATIVE PROCESS

- IP PREREQUISITE INTEGRATIVE PROCESS PLANNING AND DESIGN





MATERIALS AND RESOURCES

- MR PREREQUISITE CONSTRUCTION AND DEMOLITION WASTE MANAGEMENT PLANNING
- MR CREDIT CONSTRUCTION AND DEMOLITION WASTE MANAGEMENT
- MR CREDIT BUILDING PRODUCT DISCLOSURE AND OPTIMIZATION - SOURCING OF RAW MATERIALS
➔ OPTION 2 LEADERSHIP EXTRACTION PRACTICES
- MR CREDIT BUILDING PRODUCT DISCLOSURE AND OPTIMIZATION - MATERIAL INGREDIENTS
➔ OPTION 2 MATERIAL INGREDIENT OPTIMIZATION

INDOOR ENVIRONMENTAL QUALITY

- EQ CREDIT LOW EMITTING MATERIALS
- EQ CREDIT CONSTRUCTION AIR QUALITY MANAGEMENT PLAN

INNOVATION

- IN PILOT CREDIT  DESIGN FOR FLEXIBILITY
- IN PILOT CREDIT  SOCIAL EQUITY
- IN PILOT CREDIT  INCLUSIVE DESIGN
- IN CREDIT  DESIGN FOR DECONSTRUCTION

DECLARE LABEL

L'**ETICHETTA DECLARE** ELENCA I MATERIALI UTILIZZATI NEL PRODOTTO CON LO SCOPO DI FAR SAPERE DI COSA SONO FATTI, DOVE VENGONO PRODOTTI E COME VERRANNO SMALTITI. L'ETICHETTA DECLARE È UN INVITO ALLA RESPONSABILITÀ SIA PER I PRODUTTORI CHE PER GLI UTILIZZATORI.

LA **DECLARE LABEL** È UNA GUIDA PER SELEZIONARE I PRODOTTI, FORNISCE INFORMAZIONI IN MODO SEMPLICE E TRASPARENTE E METTE IN SOFFITTA IL GREENWASHING DECLARE, PER DEFINIRE E DICHIARARE CHE I PRODOTTI SONO PRIVI DI SOSTANZE CHIMICHE DANNOSE, FA COMPLESSE ANALISI CHIMICHE E REPERISCE INFORMAZIONI A PARTIRE DALLA FONTE DELLE MATERIE PRIME. TUTTE LE DECLARE LABEL DEI PRODOTTI pba SONO **RED LIST FREE**.

DECLARE LABEL

THE **DECLARE LABEL** LISTS THE MATERIALS IN A PRODUCT TO DISCLOSE WHAT THEY ARE MADE OF, WHERE THEY ARE PRODUCED AND HOW THEY WILL BE DISPOSED OF. THIS LABEL IS A CALL FOR RESPONSIBILITY TO PRODUCERS AND USERS ALIKE.

THE **DECLARE LABEL** IS A GUIDE TO SELECT PRODUCTS, PROVIDES INFORMATION IN A SIMPLE AND TRANSPARENT WAY AND RISES ABOVE GREENWASHING.

DECLARE TAKES COMPLEX CHEMICAL ANALYSIS AND RAW MATERIAL SOURCE LOCATION INFORMATION TO ESTABLISH THAT PRODUCTS ARE FREE FROM HAZARDOUS CHEMICALS. ALL DECLARE LABEL OF pba PRODUCTS ARE **RED LIST FREE**.

DECLARE LABEL

L'**ÉTIQUETTE DECLARE** LISTE LES MATÉRIAUX UTILISÉS DANS LES PRODUITS AFIN DE FAIRE SAVOIR DE QUOI SONT FAITS, OÙ ILS SONT FABRIQUÉS ET COMMENT LES ÉLIMINER. L'ÉTIQUETTE DECLARE EST UNE INVITATION À LA RESPONSABILITÉ SOIT POUR LES PRODUCTEURS SOIT POUR LES UTILISATEURS.

LA **DECLARE LABEL** EST UNE GUIDE POUR SÉLECTIONNER LES PRODUITS, ELLE FOURNIT INFORMATIONS DE MANIÈRE SIMPLE ET TRASPARENTE ET ÉLIMINE L'ÉCOBLANCHIMENT.

DECLARE, POUR DÉFINIR ET DÉCLARER QUE LES PRODUITS NE CONTIENNENT PAS DE SUBSTANCES NUISIBLES, FAIT DES ANALYSES CHIMIQUES COMPLEXES ET RECHERCHE INFORMATIONS À PARTIR DE LA SOURCE DES MATIÈRES PREMIÈRES.

TOUS LES ÉTIQUETTE DECLARE DES PRODUITS pba SONT **RED LIST FREE**, C'EST À DIRE QUI NE CONTIENNENT PAS D'INGRÉDIENTS FIGURANT DANS LA LISTE ROUGE.

DECLARE LABEL

LA **ETIQUETA DECLARE** HACE UNA LISTA DE LOS MATERIALES UTILIZADOS EN EL PRODUCTO CON EL OBJETIVO DE INFORMAR DE QUÉ SE COMPONEN, DÓNDE SE HACEN Y CÓMO SE ELIMINAN. LA ETIQUETA DECLARE ES UNA INVITACIÓN A LA RESPONSABILIDAD TANTO PARA LOS FABRICANTES COMO PARA LOS USUARIOS.

LA **DECLARE LABEL** ES UNA GUÍA PARA LA SELECCIÓN DE PRODUCTOS, DA INFORMACIONES DE MANERA SIMPLE Y TRASPARENTE Y SUPRIME EL ECOBLANQUEAMIENTO.

DECLARE, AL FIN DE DEFINIR Y DECLARAR QUE LOS PRODUCTOS NO CONTIENEN SUSTANCIAS QUÍMICAS DAÑOSAS, HACE ANÁLISIS QUÍMICAS COMPLEJAS Y OBTIENE INFORMACIONES A PARTIR DE LA ORIGEN DE LAS MATERIAS PRIMAS. TODAS LAS ETIQUETAS DECLARE DE LOS PRODUCTOS pba SON **RED LIST FREE**, O SEA QUE SUS COMPONENTES NO ESTÁN PRESENTE EN LA LISTA ROJA.



Declare.

STAINLESS STEEL BATHROOM ACCESSORIES AND GRAB BARS pba

Final Assembly: Tezze sul Brenta, Vicenza, Italy

Life Expectancy: 20 Year(s)

End of Life Options: Recyclable (100%)

Ingredients:

Stainless Steel AISI 316L: Stainless Steel AISI 316; **Aluminium 47100:** Aluminum; **Stainless Steel AISI 304:** Stainless Steel AISI 316; **Polyamide 6:** Nylon 6; **Stainless Steel AISI 303:** Stainless Steel AISI 316; **Brass:** Brass; **Powder coat:** Fatty acids, castor-oil, caustic-oxidized, distn. residues, esters with 1,3-butanediol; Barium sulfate; Titanium dioxide; N,N,N',N'-Tetrakis(2-hydroxyethyl)hexane diamide

Living Building Challenge Criteria: Compliant

I-13 Red List:

- LBC Red List Free % Disclosed: 100% at 100ppm
- LBC Red List Approved VOC Content: Not Applicable
- Declared

I-10 Interior Performance: Not Applicable

I-14 Responsible Sourcing: Not Applicable

PBA-0005

Original Issue Date: 2021

MANUFACTURER RESPONSIBLE FOR LABEL ACCURACY
INTERNATIONAL LIVING FUTURE INSTITUTE™ living-future.org/declare



Product design consultant: Gensler

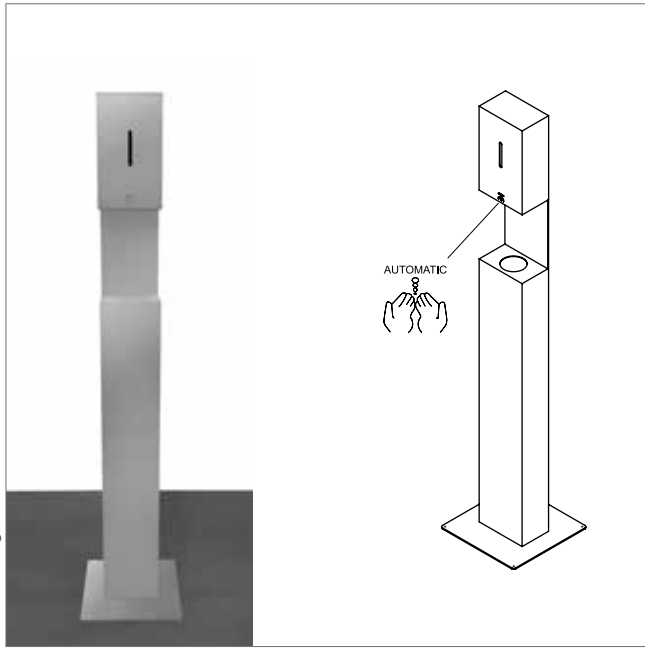

ART.
GBA.001.00D1.xx

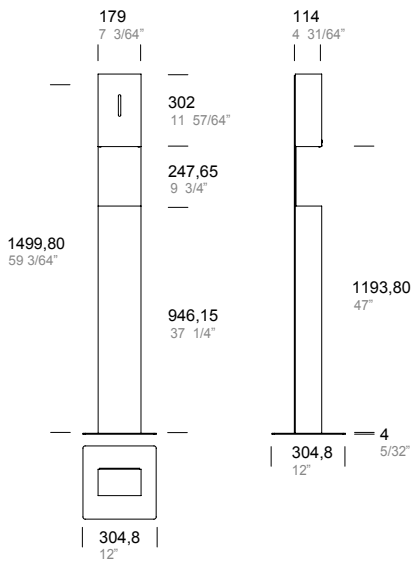

ADA
compliant

Design 1
Modello autoportante
Freestanding
Modèle autoportant
Soporte dispensador de pie

FINISHES .XX

STAINLESS STEEL



Satin
.44

STAINLESS STEEL POWDER-COATED



White
.31



Champagne
.38



Bronze
.39



Grey
.32



Black
.40

pba Hand Sanitizer Covers are compatible with all motion-activated hand sanitizer dispensers with these maximum dimensions: 298,5 mm (11.75") h x 163,9 mm (6.45") b x 104,2 mm (4.1"). See the Installation Note on page 334 for a list of hand sanitizer dispensers that have been verified as compatible.

Product design consultant: Gensler

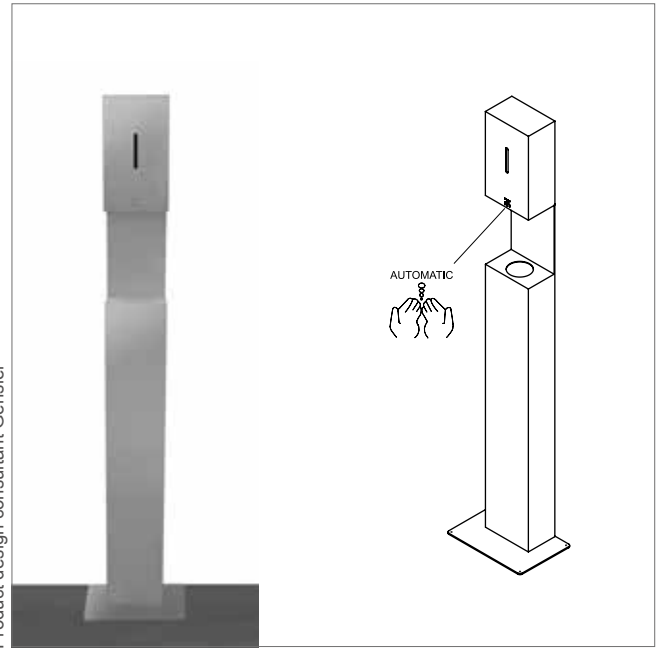

ART.
GBA.001.00D2.xx

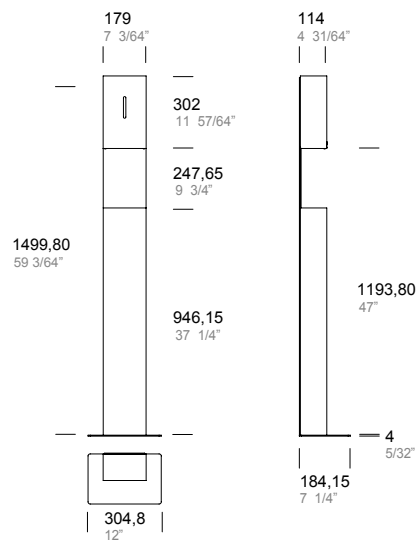

ADA
compliant

Design 2
Modello autoportante a muro
Freestanding (against wall)
Modèle autoportant au mur
Soporte dispensador de pie contra pared



Available with removable deep drip tray see page 334.



THESE PRODUCTS CONTRIBUTE TO LEED® CREDITS

Product design consultant Gensler

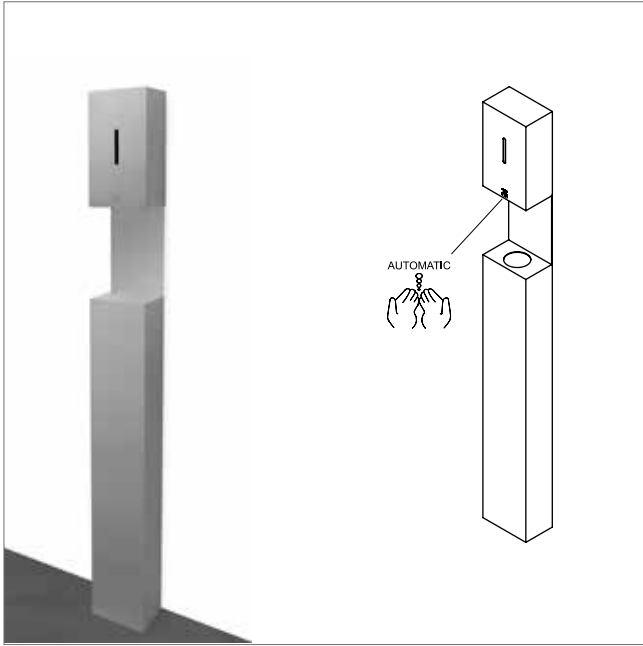

ART.
GBA.001.00D3.xx

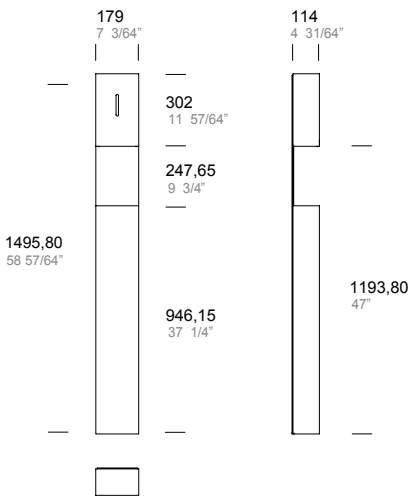

Design 3
Modello con fissaggio a parete
Wall-mounted
Modèle fixé au mur
Soporte dispensador mural

FINISHES .XX

STAINLESS STEEL



Satin
.44

STAINLESS STEEL POWDER-COATED



White
.31



Champagne
.38



Bronze
.39



Grey
.32



Black
.40

pba Hand Sanitizer Covers are compatible with all motion-activated hand sanitizer dispensers with these maximum dimensions: 298,5 mm (11.75") h x 163,9 mm (6.45") b x 104,2 mm (4.1"). See the Installation Note on page 334 for a list of hand sanitizer dispensers that have been verified as compatible.



Available with removable deep drip tray see page 334.



THESE PRODUCTS CONTRIBUTE TO LEED® CREDITS



Product design consultant: Gensler

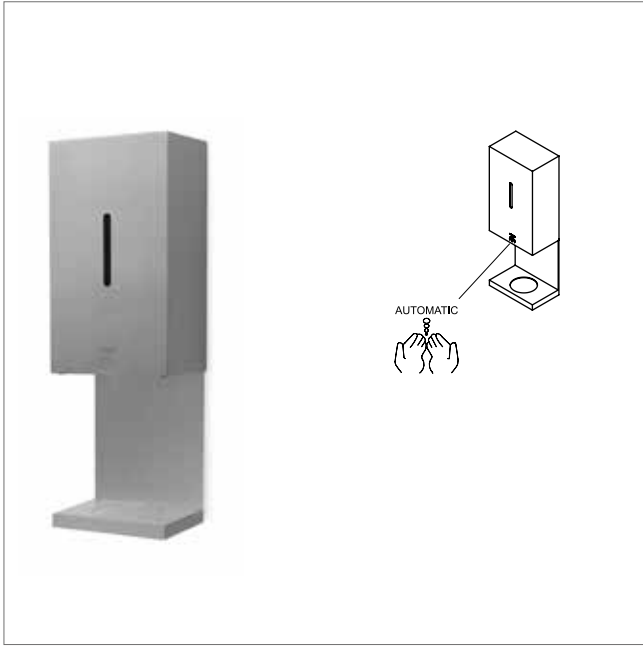

ART.
GBA.001.00D4.xx

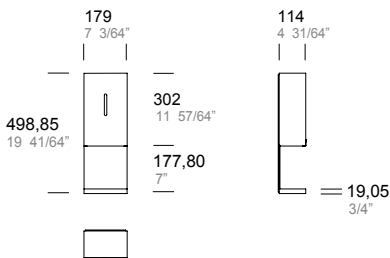

ADA compliant
when wall-mounted
over a counter or
similar and not in
the circulation path.

Design 4
Modello con fissaggio a parete
Wall-mounted
Modèle fixé au mur
Soporte dispensador mural

FINISHES .XX

STAINLESS STEEL



Satin
.44

STAINLESS STEEL POWDER-COATED



White
.31



Champagne
.38



Bronze
.39



Grey
.32



Black
.40

pba Hand Sanitizer Covers are compatible with all motion-activated hand sanitizer dispensers with these maximum dimensions: 298,5 mm (11.75") h x 163,9 mm (6.45") b x 104,2 mm (4.1"). See the Installation Note on page 334 for a list of hand sanitizer dispensers that have been verified as compatible.

Product design consultant: Gensler

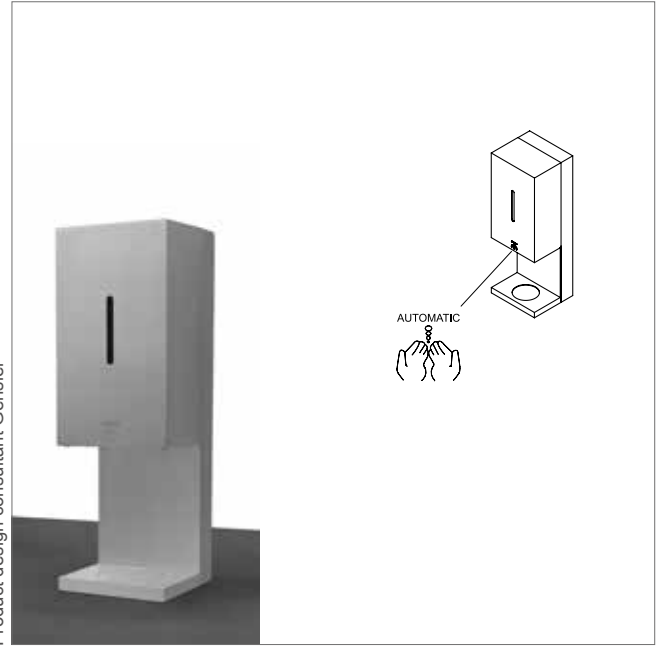

ART.
GBA.001.00D5.xx

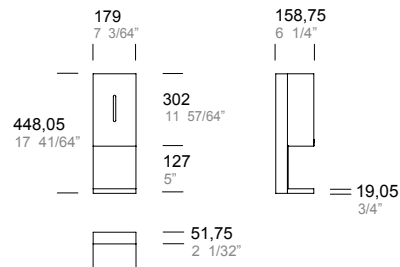

Design 5
Modello da tavolo
Countertop
Modèle d'appui
Soporte dispensador de sobremesa



Available with removable deep drip tray see page 334.



THESE PRODUCTS CONTRIBUTE TO LEED® CREDITS

**LASER CUT
LOGO CUSTOMIZATION**

SATIN FINISH



STAINLESS STEEL



Satin
.44

**LASER CUT
LOGO CUSTOMIZATION**

POWDER-COATED FINISH



STAINLESS STEEL POWDER-COATED



White .31
Champagne .38
Bronze .39
Grey .32
Black .40

**LASER CUT / BACKFILLED
LOGO CUSTOMIZATION**

SATIN FINISH



STAINLESS STEEL



Satin
.44

**LASER CUT / BACKFILLED
LOGO CUSTOMIZATION**

POWDER-COATED FINISH



STAINLESS STEEL POWDER-COATED



White .31
Champagne .38
Bronze .39
Grey .32
Black .40

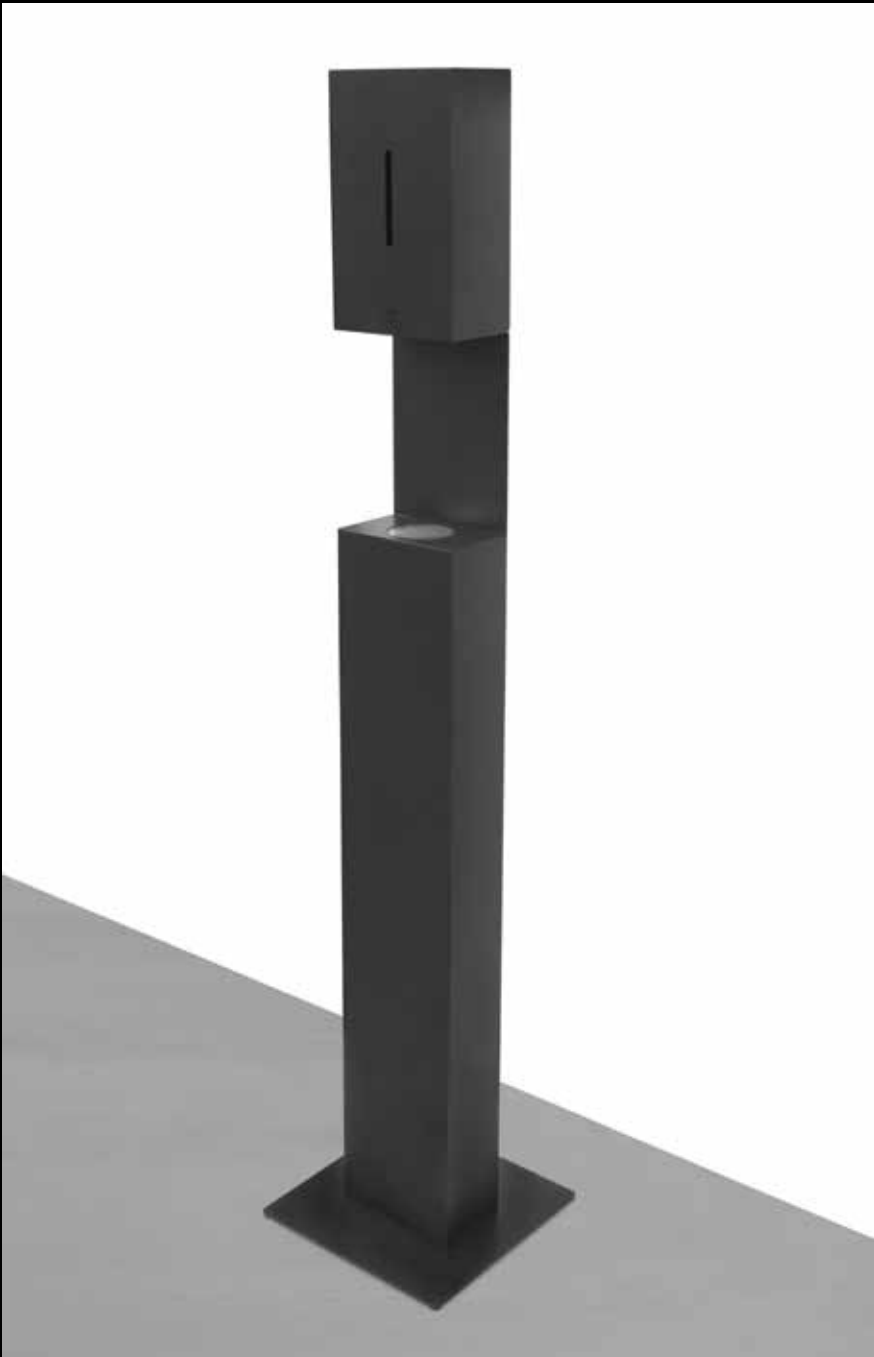









pba PER LA CERTIFICAZIONE LEED®

LEED® (LEADERSHIP IN ENERGY ENVIRONMENTAL DESIGN) È UN SISTEMA DI CERTIFICAZIONE A BASE VOLONTARIA PER LA GESTIONE, LA PROGETTAZIONE E LA COSTRUZIONE DI EDIFICI SOSTENIBILI DAL PUNTO DI VISTA SOCIALE, AMBIENTALE, ECONOMICO E DEL BENESSERE PER GLI UTILIZZATORI.





I PRODOTTI pba CONTRIBUISCONO AI PREREQUISITI E AI CREDITI LEED®.

PROCESSO INTEGRATO	IP	
MATERIALI E RISORSE	MR	
QUALITÀ DELL'AMBIENTE INTERNO	EQ	
INNOVAZIONE	I	

pba FOR LEED® CERTIFICATION

LEED® (LEADERSHIP IN ENERGY ENVIRONMENTAL DESIGN) IS A VOLUNTARY CERTIFICATION SYSTEM FOR THE MANAGEMENT, DESIGN AND CONSTRUCTION OF BUILDINGS THAT ARE SUSTAINABLE FROM A SOCIAL, ENVIRONMENTAL AND ECONOMIC POINT OF VIEW AND IN TERMS OF THE WELLBEING OF THE USERS.





pba PRODUCTS CONTRIBUTE TOWARD SATISFYING PREREQUISITES AND CREDITS UNDER LEED®.

INTEGRATED PROCESS	IP	
MATERIALS AND RESOURCES	MR	
INDOOR ENVIRONMENTAL QUALITY	EQ	
INNOVATION	I	

pba POUR LA CERTIFICATION LEED®

LEED® (LEADERSHIP IN ENERGY ENVIRONMENTAL DESIGN) EST UN SYSTÈME DE CERTIFICATION À BASE VOLONTAIRE POUR LA GESTION, LA CONCEPTION ET LA CONSTRUCTION DE BÂTIMENTS DURABLES D'UN POINT DE VUE SOCIAL, ENVIRONNEMENTAL, ÉCONOMIQUE ET DU BIEN-ÊTRE POUR LES UTILISATEURS.

LES PRODUITS pba CONTRIBUENT AUX CONDITIONS PRÉALABLES REQUISES ET AUX CRÉDITS LEED®.

PROCESSUS DE CONCEPTION INTÉGRÉE	IP	
MATÉRIAUX ET RESSOURCES	MR	
QUALITÉ DES ENVIRONNEMENTS INTÉRIEURS	EQ	
INNOVATION	I	

pba PARA LA CERTIFICACIÓN LEED®

LEED® (LEADERSHIP IN ENERGY ENVIRONMENTAL DESIGN) ES UN SISTEMA DE CERTIFICACIÓN DE BASE VOLUNTARIA PARA LA GESTIÓN, EL DISEÑO Y LA CONSTRUCCIÓN DE EDIFICIOS SOSTENIBLES DESDE EL PUNTO DE VISTA SOCIAL, MEDIOAMBIENTAL, ECONÓMICO Y DEL BIENESTAR PARA LOS USUARIOS.

LOS PRODUCTOS pba CONTRIBUYEN EN LOS PRE-REQUISITOS Y EN LOS CRÉDITOS LEED®.



PROCESO INTEGRADO	IP	
MATERIALES Y RECURSOS	MR	
CALIDAD DEL AMBIENTE INTERNO	EQ	
INNOVACIÓN	I	

CHART OF PBA PRODUCTS CONTRIBUTION TO LEED V4

INTEGRATIVE PROCESS

- IP PREREQUISITE INTEGRATIVE PROCESS PLANNING AND DESIGN





MATERIALS AND RESOURCES

- MR PREREQUISITE CONSTRUCTION AND DEMOLITION WASTE MANAGEMENT PLANNING
- MR CREDIT CONSTRUCTION AND DEMOLITION WASTE MANAGEMENT
- MR CREDIT BUILDING PRODUCT DISCLOSURE AND OPTIMIZATION - SOURCING OF RAW MATERIALS
➔ OPTION 2 LEADERSHIP EXTRACTION PRACTICES
- MR CREDIT BUILDING PRODUCT DISCLOSURE AND OPTIMIZATION - MATERIAL INGREDIENTS
➔ OPTION 2 MATERIAL INGREDIENT OPTIMIZATION

INDOOR ENVIRONMENTAL QUALITY

- EQ CREDIT LOW EMITTING MATERIALS
- EQ CREDIT CONSTRUCTION AIR QUALITY MANAGEMENT PLAN

INNOVATION

- IN PILOT CREDIT  DESIGN FOR FLEXIBILITY
- IN PILOT CREDIT  SOCIAL EQUITY
- IN PILOT CREDIT  INCLUSIVE DESIGN
- IN CREDIT  DESIGN FOR DECONSTRUCTION



Page 310



Page 310



Page 310



Page 312



Page 312

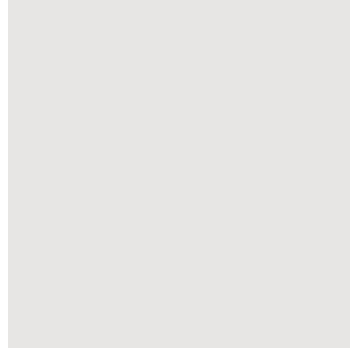
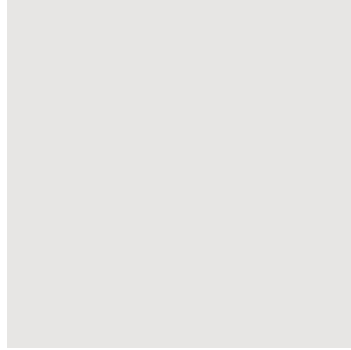
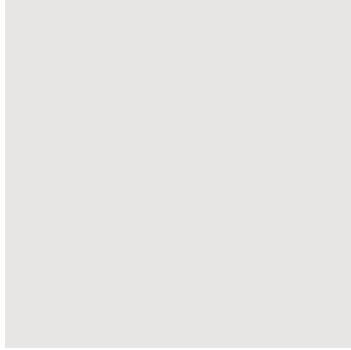
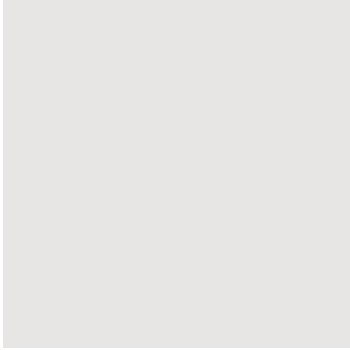
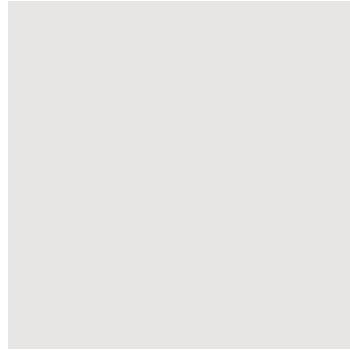
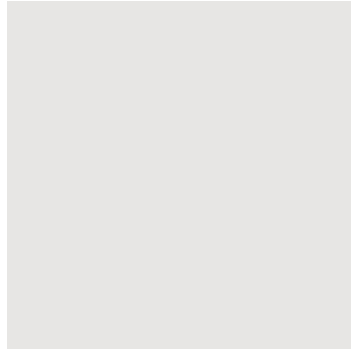
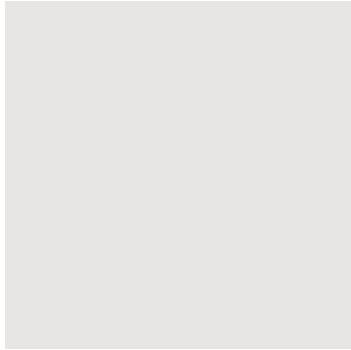
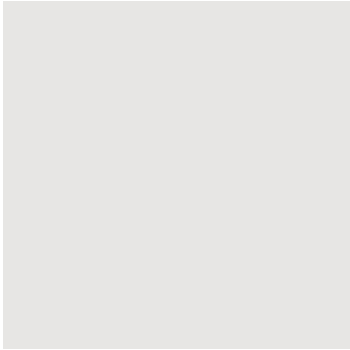

Page 311



Page 311



Page 311

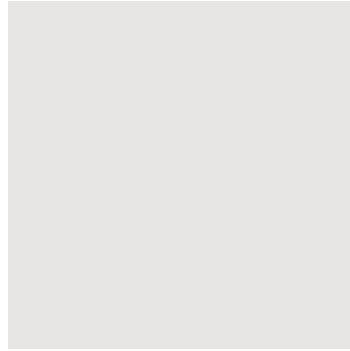

Page 313



Page 313

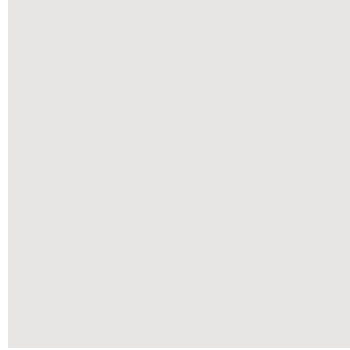
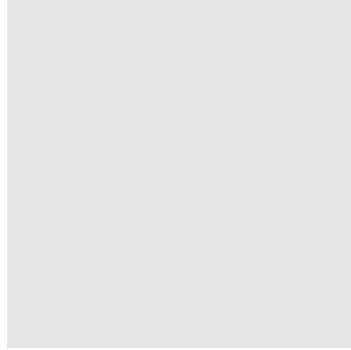
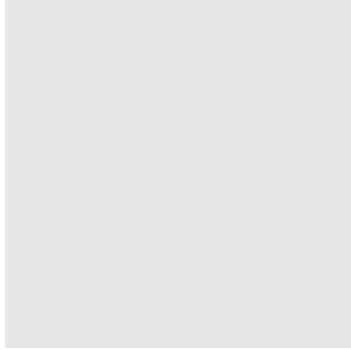
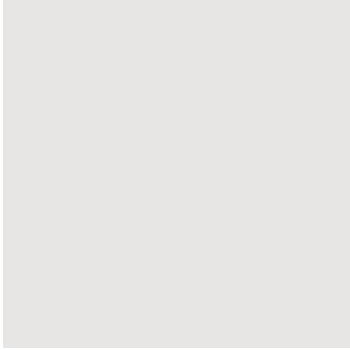
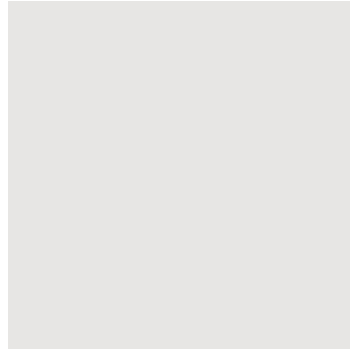
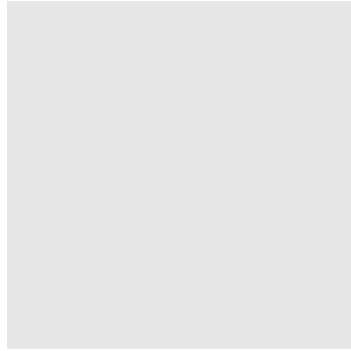
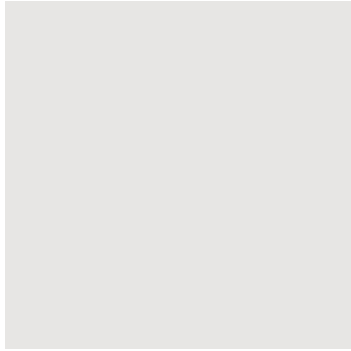
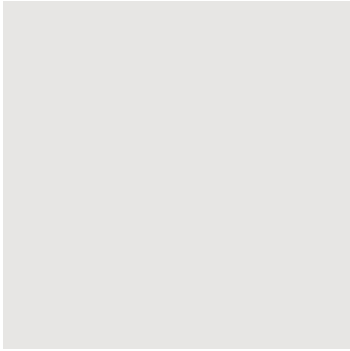
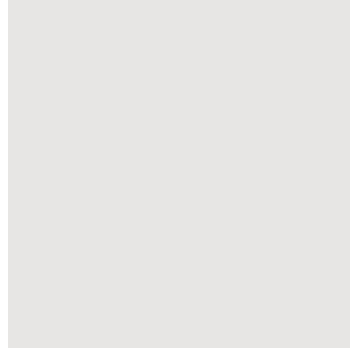
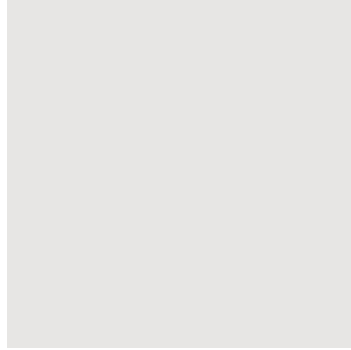

CORRIMANO CON SUPPORTO DRITTO
HANDRAIL WITH STRAIGHT SUPPORT
MAIN COURANTE AVEC SUPPORT DROITE
PASAMANO CON SOPORTE RECTO

Tratti piani
Level surfaces
Surfaces planes
Tramos rectos

Tratti inclinati
Sloping surfaces
Surfaces inclinées
Tramos inclinados

Calandrato
Bended
Circulaire
Tramos curvos

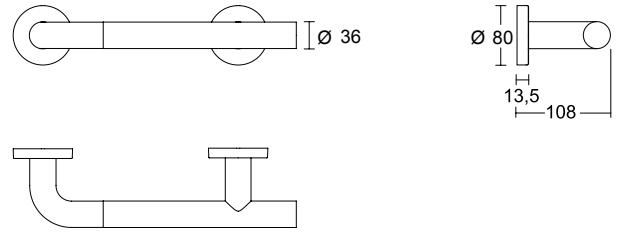

ART.

- 4CN.NYD.0002 . xx
- ↗ 4CN.NYD.0102 . xx
- ⤿ 4CN.NYD.0301 . xx

👤 5CN.557.00VB . xx
($\alpha = 90^\circ - 120^\circ$)

Corrimano in Poliammide con anima in alluminio
Polyamide handrail with aluminium core
Main courante en Polyamide avec âme en aluminium
Pasamano de Poliamida con alma de aluminio

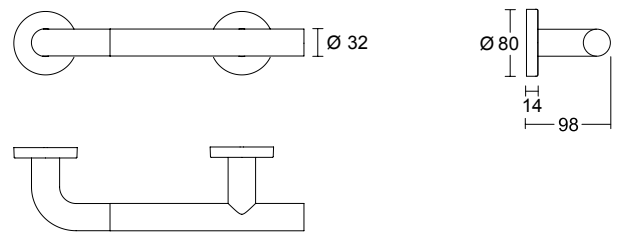

ART.

- 4CS.00D.0002 . xx
- ↗ 4CS.00D.0102 . xx
- ⤿ 4CS.00D.0301 . xx

👤 4CS.0SN.0000 . xx
($\alpha = 150^\circ - 180^\circ$)

Corrimano in Acciaio Inox AISI 316L
AISI 316L Stainless Steel handrail
Main courante en Acier Inoxydable AISI 316L
Pasamano de Acero Inoxidable AISI 316L

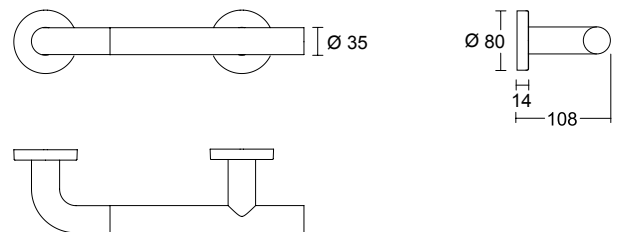

ART.

- 4WS.00D.0002 . xx
- ↗ 4WS.00D.0102 . xx

👤 4CS.WSN.0000 . xx
($\alpha = 150^\circ - 180^\circ$)

Corrimano in Legno di faggio con supporti in Acciaio Inox AISI 316L
Wooden beech handrail with AISI 316L Stainless Steel supports
Main courante en Hêtre avec supports en Acier Inox AISI 316L
Pasamano de Madera de haya con soportes de Acero Inoxidable AISI 316L

Standard:
Faggio Verniciato Trasparente
Transparent Powder-coated Beech
Hêtre Laqué Transparent
Haya Lacado Transparente

On request:
Frassino Rovere
Ash Oak
Frêne Chêne
Fresno Roble

THESE PRODUCTS CONTRIBUTE TO LEED® CREDITS

.XX FINISH

POLYAMIDE 6

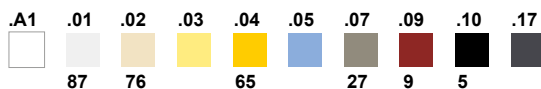

STAINLESS STEEL



WOOD



CORRIMANO CON SUPPORTO CURVATO
HANDRAIL WITH CURVED SUPPORT
MAIN COURANTE AVEC SUPPORT COUDÉ
PASAMANO CON SOPORTE CURVO

— Tratti piani
Level surfaces
Surfaces planes
Tramos rectos

↗ Tratti inclinati
Sloping surfaces
Surfaces inclinées
Tramos inclinados

⤿ Calandrato
Bended
Circulaire
Tramos curvos

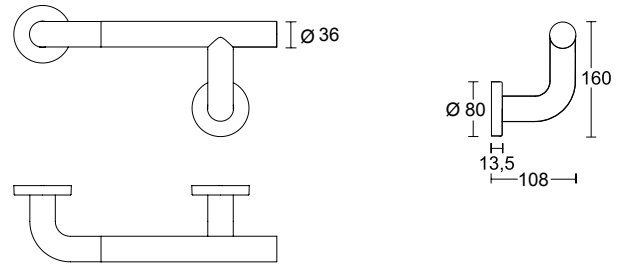

ART.

- 4CN.NYC.0002 . xx
- ↗ 4CN.NYC.0102 . xx
- ⤿ 4CN.NYC.0301 . xx

↻ 5CN.557.00VB . xx
($\alpha = 90^\circ - 120^\circ$)

Corrimano in Poliammide con anima in alluminio
Polyamide handrail with aluminium core
Main courante en Polyamide avec âme en aluminium
Pasamano de Poliamida con alma de aluminio

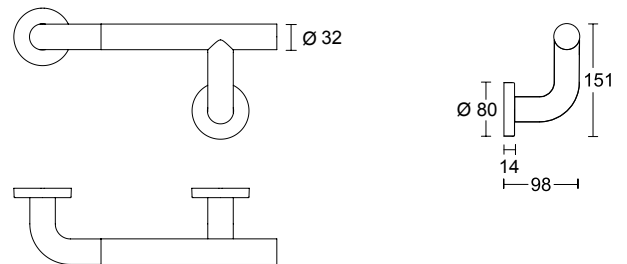

ART.

- 4CS.00C.0002 . xx
- ↗ 4CS.00C.0102 . xx
- ⤿ 4CS.00C.0301 . xx

↻ 4CS.0SN.0000 . xx
($\alpha = 150^\circ - 180^\circ$)

Corrimano in Acciaio Inox AISI 316L
AISI 316L Stainless Steel handrail
Main courante en Acier Inoxydable AISI 316L
Pasamano de Acero Inoxidable AISI 316L

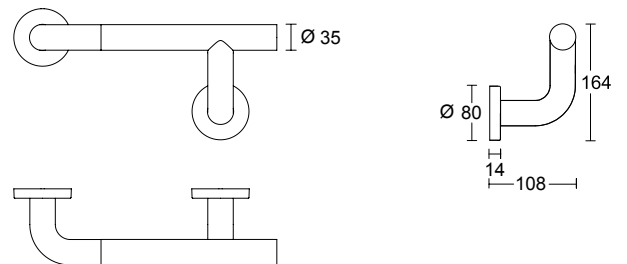

ART.

- 4WS.00C.0002 . xx
- ↗ 4WS.00C.0102 . xx

↻ 4CS.WSN.0000 . xx
($\alpha = 150^\circ - 180^\circ$)

Corrimano in Legno di faggio con supporti in Acciaio Inox AISI 316L
Wooden beech handrail with AISI 316L Stainless Steel supports
Main courante en Hêtre avec supports en Acier Inox AISI 316L
Pasamano de Madera de haya con soportes de Acero Inoxidable AISI 316L

Standard:
Faggio Verniciato Trasparente
Transparent Powder-coated Beech
Hêtre Laqué Transparent
Haya Lacado Transparente

On request:
Frassino Rovere
Ash Oak
Frêne Chêne
Fresno Roble

THESE PRODUCTS CONTRIBUTE TO LEED® CREDITS

.XX FINISH

POLYAMIDE 6										
	.A1	.01	.02	.03	.04	.05	.07	.09	.10	.17
LRV	87	76	65	27	9	5				

STAINLESS STEEL	
.44	.43
53	70



CORRIMANO CON SUPPORTO CURVATO Ø 20
 HANDRAIL WITH CURVED SUPPORT Ø 20
 MAIN COURANTE AVEC SUPPORT COUDÉ Ø 20
 PASAMANO CON SOPORTE CURVO Ø 20

Tratti piani
 Level surfaces
 Surfaces planes
 Tramos rectos

Tratti inclinati
 Sloping surfaces
 Surfaces inclinées
 Tramos inclinados

Calandrato
 Bended
 Circulaire
 Tramos curvos

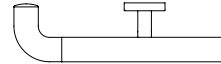
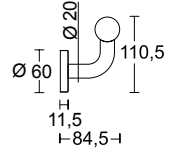
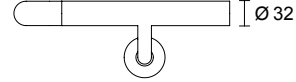

ART.

4CS.00P.0001 . xx

4CS.00P.0101 . xx

4CS.00P.0301 . xx

4CS.0SN.0000 . xx
 ($\alpha = 150^\circ - 180^\circ$)

Corrimano in Acciaio Inox AISI 316L
 AISI 316L Stainless Steel handrail
 Main courante en Acier Inoxydable AISI 316L
 Pasamano de Acero Inoxidable AISI 316L

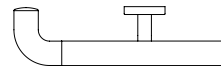
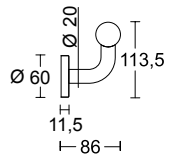
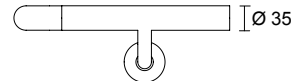

ART.

4WP.001.0000 . xx

4WP.101.0000 . xx

4CS.WSN.0000 . xx
 ($\alpha = 150^\circ - 180^\circ$)

Corrimano in Legno di faggio con supporti in Acciaio Inox AISI 316L
 Wooden beech handrail with AISI 316L Stainless Steel supports
 Main courante en Hêtre avec supports en Acier Inox AISI 316L
 Pasamano de Madera de haya con soportes de Acero Inoxidable AISI 316L

Standard:
 Faggio Verniciato Trasparente
 Transparent Powder-coated Beech
 Hêtre Laqué Transparent
 Haya Lacado Transparente

On request:
 Frassino Rovere
 Ash Oak
 Frêne Chêne
 Fresno Roble

THESE PRODUCTS CONTRIBUTE TO LEED® CREDITS

.XX FINISH

STAINLESS STEEL

.44 .43

LVR

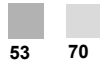

WOOD



CORRIMANO CON SUPPORTO A 90°
HANDRAIL WITH 90° SUPPORT
MAIN COURANTE AVEC SUPPORT ANGLE DROIT À 90°
PASAMANO CON SOPORTE A 90°

- | | | | | | |
|---|--|---|---|---|---|
| — | Tratti piani
Level surfaces
Surfaces planes
Tramos rectos | ⌋ | Tratti inclinati
Sloping surfaces
Surfaces inclinées
Tramos inclinados | ⤿ | Calandrato
Bended
Circulaire
Tramos curvos |
|---|--|---|---|---|---|

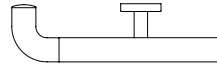
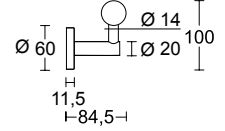
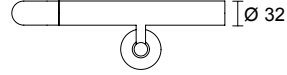

ART.

- 4CS.00R.0001 . xx
- ⌋ 4CS.00R.0101 . xx
- ⤿ 4CS.00R.0301 . xx

⌋ 4CS.0SN.0000 . xx
(α = 150° - 180°)

Corrimano in Acciaio Inox AISI 316L
AISI 316L Stainless Steel handrail
Main courante en Acier Inoxydable AISI 316L
Pasamano de Acero Inoxidable AISI 316L

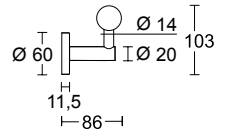
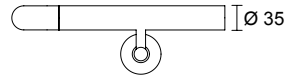

ART.

- 4WR.001.0000 . xx
- ⌋ 4WR.101.0000 . xx

⌋ 4CS.WSN.0000 . xx
(α = 150° - 180°)

Corrimano in Legno di faggio con supporti in Acciaio Inox AISI 316L
Wooden beech handrail with AISI 316L Stainless Steel supports
Main courante en Hêtre avec supports en Acier Inox AISI 316L

Standard:
Faggio Verniciato Trasparente
Transparent Powder-coated Beech
Hêtre Laqué Transparent
Haya Lacado Transparente

On request:
Frassino Rovere
Ash Oak
Frêne Chêne
Fresno Roble

THESE PRODUCTS CONTRIBUTE TO LEED® CREDITS

.XX FINISH

STAINLESS STEEL

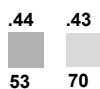

WOOD



INFORMAZIONI TECNICHE

TECHNICAL INFORMATION

INFORMATIONS TECHNIQUES

INFORMACIONES TÉCNICAS

CERTIFICATO TÜV - TÜV CERTIFICATE
CERTIFICAT TÜV - CERTIFICACIÓN TÜV



Certificate N° : Z1 029615 0020 Rev. 00

CONFORMITÀ CE - CE CONFORMITY
CONFORMITÉ CE - CONFORMIDAD CE



Regulation UE 2017/745
Directive 2014/35/UE

TEST CITOTOSSICITÀ - CITOTOXICITY TEST
TEST DE CYTOTOXICITÉ
PRUEBA DE CITOTOXICIDAD

Cytotoxicity test to DIN EN ISO 10993-5

MATERIALI - MATERIALS - MATÉRIAUX - MATERIALES



NYLON

- Resina termoplastica (Poliammide 6).
- Alta resistenza meccanica.
- Tenacità agli urti.
- Resistenza ad usura e abrasione.
- Comportamento antistatico, buon potere di isolamento elettrico e buona resistenza alle correnti striscianti.
- Buona stabilità ad agenti chimici quali idrocarburi, oli, grassi e buona resistenza agli agenti chimici come per esempio solventi, detersivi e disinfettanti.
- Scarsa conducibilità termica.
- Classificata come autoestinguenta di categoria UL 94V-2 e non emana gas tossici.
- È fisiologicamente innocuo.
- Soddisfa i requisiti della direttiva 2011/65/EU e non contiene Piombo (Pb), Mercurio (Hg), Cromo Esivalente Cr+6, Bifenili polibromurati (PBB), Etere di difenile polibromurato (PBDE), Cadmio (Cd).

ALLUMINIO

- Robustezza meccanica.
- Ridotto peso specifico.
- Ottima resistenza alla corrosione.

NYLON

- Thermoplastic resin (Polyamide 6).
- High mechanical resistance.
- Tenacity.
- Resistance to wear and abrasion.
- Antistatic, with good insulating power and good resistance to creeping currents.
- Good stability to chemical agents such as hydrocarbons, oils and fats; good resistance to numerous chemical agents such as solvents, detergents and disinfectants.
- Poor thermal conduction.
- Classified as self-extinguishable into category UL 94V-2. It does not generate toxic gases.
- Physiologically innocuous.
- Compliance with the requirements of Directive 2011/65/EU. It is also free of Lead (Pb), Mercury (Hg), Hexavalent Chromium (Cr+6), Polybrominated Biphenyls (PBB), Polybrominated Diphenyl Ethers (PBDE) and Cadmium (Cd).

ALUMINUM

- Mechanical strength.
- Reduced specific weight.
- Excellent resistance to corrosion.

NYLON

- Résine thermoplastique (Polyamide 6).
- Résistance mécanique élevée.
- Grande résistance aux chocs.
- Résistance à l'usure et à l'abrasion.
- Comportement antistatique, bon pouvoir d'isolation électrique et bonne résistance aux courants rampants.
- Bonne stabilité aux agents chimiques, tels que les hydrocarbures, les huiles et les graisses et bonne résistance aux nombreux agents chimiques tels que les solvants, les détergers et les désinfectants.
- Faible conductivité thermique.
- Classé comme auto-extinguible de catégorie UL 94V-2, il ne libère pas de gaz toxiques.
- Physiologiquement inoffensif.
- Conforme aux directives 2011/65/EU et il ne contient ni de plomb (Pb), ni de mercure (Hg), ni de chrome hexavalent (Cr+6), ni de polybromodiphényles (PBB), ni de polybromodiphényléthers (PBDE), ni de cadmium (Cd).

ALUMINIUM

- Robustesse mécanique.
- Poids spécifique réduit.
- Très bonne résistance à la corrosion.

NYLON

- Resina de termoplástica (Poliamida 6).
- Alta resistencia mecánica.
- Resistencia contra impactos.
- Resistencia a desgaste y abrasión.
- Comportamiento antiestático, buen poder de aislamiento eléctrico y buena resistencia a corrientes de arrastre.
- Buena estabilidad a agentes químicos como hidrocarburos, aceites, grasas y buena resistencia a numerosísimos agentes químicos, como, por ejemplo, disolventes, detergentes y desinfectantes.
- Escasa conductibilidad térmica.
- Clasificada como auto-extinguible de clase UL 94V-2 y no emana gases tóxicos.
- Es fisiológicamente inocuo.
- Conforme a los requisitos de las directivas 2011/65/EU, no contiene plomo (Pb), mercurio (Hg), cromo hexavalente (Cr+6y), polibromobifenilos (PBB), polibromodifenil éteres (PBDE), y cadmio (Cd).

ALUMINIO

- Robustez mecánica.
- Extraordinaria ligereza.
- Buena resistencia a corrosión.

PULIZIA - MAINTENANCE - NETTOYAGE - LIMPIEZA

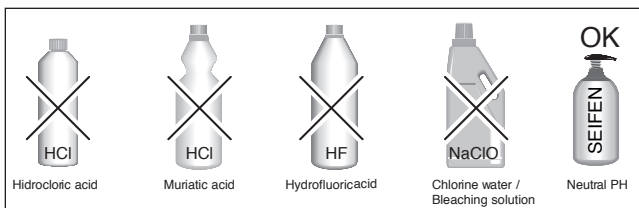

ELEMENTI COSTRUTTIVI - STRUCTURAL ELEMENTS - ELEMENTS CONSTRUCTIFS - ELEMENTOS CONSTRUCTIVOS

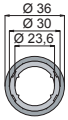
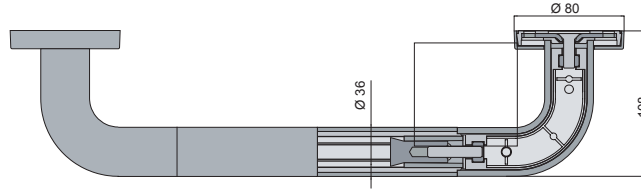

ELEMENTO RETTILINEO
Tubo in nylon estruso Ø 36 mm, senza linee di saldatura, con anima in alluminio.
STRAIGHT ELEMENT
Rail made of extruded seamless nylon Ø 36 mm, without shut, with a full-length aluminium core.
ÉLÉMENT RECTILIGNE
Tube en nylon extrudé Ø 36 mm, sans plan de joint, avec âme en aluminium.
ELEMENTO RECTILÍNEO
Tubo de nylon extruído Ø 36 mm sin soldaduras y con alma metálica de aluminio.

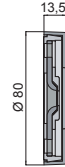

ROSETTA
Flangia in acciaio ricoperta di nylon stampato e coperchio a scatto.
ROSE
Flange in steel covered in coloured nylon and snap-on cap.
ROSACE
Bride an acier recouverte de nylon moulé et de couvercle à déclic.
ROSETA
Roseta de acero recubierta de nylon moldeado y tapa de resorte.

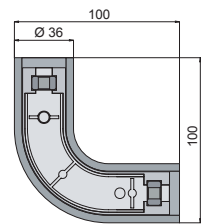

ELEMENTO CURVO A 90°
Curva in nylon stampato con anima interna.
90° BEND
Moulded nylon bend with core.
ÉLÉMENT CINTRÉ À 90°
Coude en nylon moulé avec âme interne.
ELEMENTO CURVO EN ÁNGULO DE 90°
Codo de nylon moldeado con ánima interna.

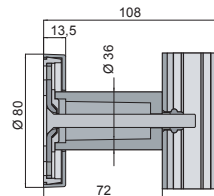

SUPPORTO DRITTO
Supporto in nylon stampato con anima interna.
STRAIGHT SUPPORT
Moulded nylon support with aluminium core.
SUPPORT DROIT
Support en nylon moulé avec âme interne.
SOPORTE RECTO
Soporte de nylon moldeado con ánima interna.

ADIPOSE SERIE

ELEMENTI COSTRUTTIVI - STRUCTURAL ELEMENTS - ELEMENTS CONSTRUCTIFS - ELEMENTOS CONSTRUCTIVOS

La rosetta con anima in acciaio inox di spessore 25/10 è fissata tramite una vite in acciaio inox che si connette all'anima metallica delle curve a 90°. Il tubo è connesso mediante uno speciale tassello metallico pba ad espansione a sezione rinforzata che si avvita nell'anima della curva.

The rose with stainless steel core of 25/10 thickness is fixed by a stainless steel screw that connects to the metal core of the 90° bends. The tube is connected by a special pba metal insert with a reinforced section that is screwed into the core of the bend.

La rosace avec âme en acier inox épaisseur de 25/10 est fixée par une vis en acier inox qui se connecte au noyau métallique des coudes à 90°. Le tube est relié par un insert métallique spécial pba avec une section renforcée qui est vissée dans le noyau de la coude.

La roseta con alma de acero inoxidable de 25/10 de espesor se fija mediante un tornillo de acero inoxidable que se conecta a la alma de metal de los codos en ángulo de 90°. El tubo está conectado mediante un inserto de metal pba especial con una sección reforzada que se atornilla en la alma del codo.

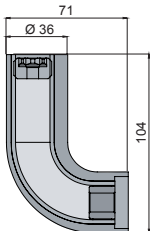
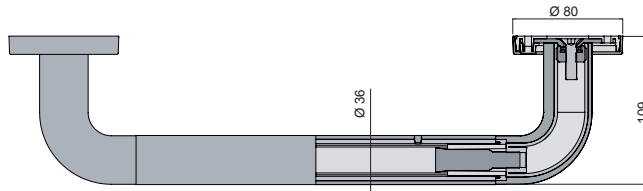

ELEMENTO CURVO A 90°
Curva speciale pba in nylon stampato con anima interna composta da tubolare in acciaio inox Ø25, spessore 2,5mm e due inserti metallici filettati alle estremità.
90° BEND
Special moulded nylon pba Bend with internal core made of stainless steel tube Ø25, thickness 2,5mm and solid metallic bushes on both sides.
ELEMENT À 90°
Coude spécial pba en nylon moulé avec âme interne en tube d'acier inoxydable Ø25, épaisseur 2,5mm et douilles métalliques filetéés aux deux côtés.
ELEMENTO CURVO EN ÁNGULO DE 90°
Codo especial pba de nylon moldeado con alma interna en tubo de acero inoxidable Ø25, de espesor 2,5 mm y casquillos metálicos roscados en ambos lados.

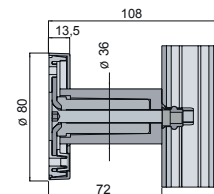

SUPPORTO DRITTO
Supporto in nylon stampato con anima interna.
STRAIGHT SUPPORT
Moulded nylon support with aluminium core.
SUPPORT DROIT
Support en nylon moulé avec âme interne.
SOPORTE RECTO
Soporte de nylon moldeado con alma interna.

ANTISUICIDE SERIE



POLYAMIDE-6 AND METAL COMPONENTS ARE COMPLETELY SEPARABLE FOR RECYCLING

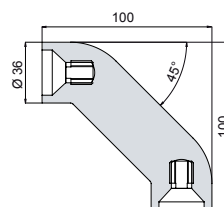

ELEMENTO INCLINATO A 45°
45° INCLINED BEND
ÉLÉMENT INCLINÉ À ANGLE 45°
ELEMENTO INCLINADO EN ÁNGULO DE 45°

GUIDA AL PROGETTO - GUIDE TO THE PROJECT - DESCRIPTIF PROJET - GUÍA PARA EL PROYECTO

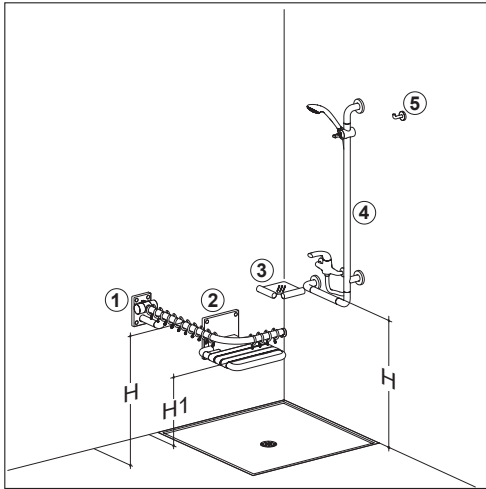

- ① 4CN.435.0000
- ② 4CN.447.000B
- ③ 4CN.493.0000
- ④ 4CN.22J.00LA
- ⑤ 4CN.488.0000

(D)	DIN 18040-1 DIN 18040-2	H= 850	H1= 460/480
(I)	DM 236 14/06/1989	H= 800	H1= 450/500
(GB)	APPROVED DOCUMENT M	H= 680	H1= 480
(A)	Ö - NORM B 1600	H= 750/850	H1= 460/480
(F)	JORF n°195 (24/08/2006) Text 14 AFNOR NF P 99-611	H= 700/800	H1= 450/500
(CH)	SIA 500	H= 700/750	H1= 460

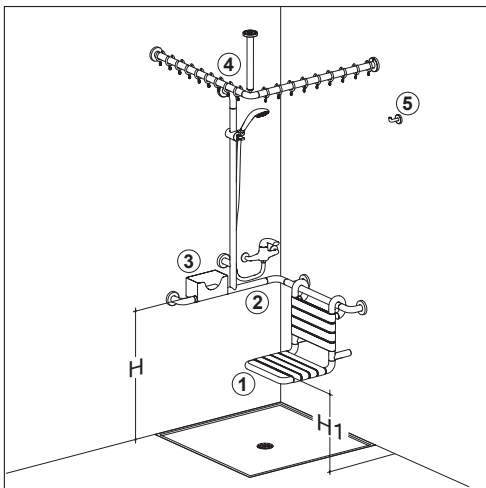

- ① 4CN.446.000B
4CN.446.000BL
- ② 4CN.43J.000B
- ③ 4CN.492.000B
- ④ 4CN.436.000B
- ⑤ 4CN.488.0000

(D)	DIN 18040-1 (4CN.446.00BL) DIN 18040-2 (4CN.446.00BL)	H= 850	H1= 480
(I)	DM 236 14/06/1989 (4CN.446.000B)	H= 800	H1= 495
(GB)	APPROVED DOCUMENT M	H= 680	H1= -
(A)	Ö - NORM B 1600 (4CN.446.000B) (4CN.446.00BL)	H= 765/785 H= 830/850	H1= 460/480 H1= 460/480
(F)	JORF n°195 (24/08/2006) Text 14 AFNOR NF P 99-611 (4CN.446.000B)	H= 755/800	H1= 450/495
(CH)	SIA 500	H= 700/750	H1= 460

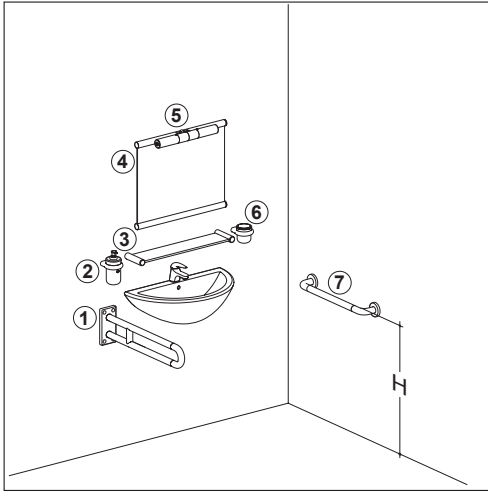

<p>(D) DIN 18040-1 DIN 18040-2</p> <p>(I) DM 236 14/06/1989</p> <p>(GB) APPROVED DOCUMENT M</p> <p>(A) Ö - NORM B 1600</p> <p>(F) JORF n°195 (24/08/2006) Text 14 AFNOR NF P 99-611</p> <p>(CH) SIA 500</p>	<p>H= 850</p> <p>H= 800</p> <p>H= 680</p> <p>H= 750</p> <p>H= 700/800</p> <p>H= 700/750</p>
---	---

- | | |
|------------------|------------------|
| (1) 4CN.441.000P | (6) 4CN.483.00BN |
| (2) 4CN.456.0000 | (7) 4CN.440.0000 |
| (3) 4CN.484.00AL | |
| (4) 4CN.470.0000 | |
| (5) 4CN.407.0TUC | |

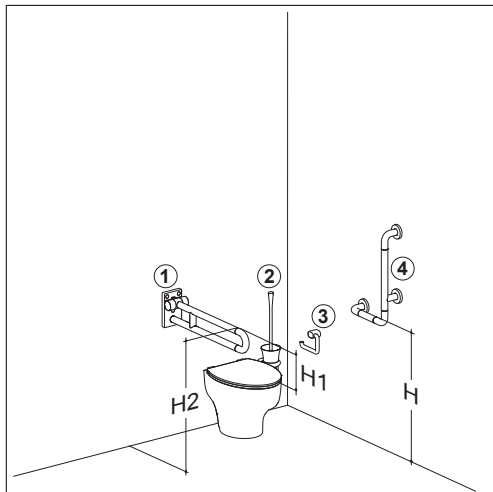

<p>(D) DIN 18040-1 DIN 18040-2</p> <p>(I) DM 236 14/06/1989</p> <p>(GB) APPROVED DOCUMENT M</p> <p>(A) Ö - NORM B 1600</p> <p>(F) JORF n°195 (24/08/2006) Text 14 AFNOR NF P 99-611</p> <p>(CH) SIA 500</p>	<p>H= 850 H1= 280 H1= 740/760</p> <p>H= 800 H1= - H2= 800</p> <p>H= 680 H1= - H2= 680</p> <p>H= 750 H1= - H2= 750</p> <p>H= 700/800 H1= - H2= 700/800</p> <p>H= 700/750 H1= 290 H2= 700/750</p>
---	---

- | |
|------------------|
| (1) 4CN.445.000R |
| (2) 4CN.486.000C |
| (3) 4CN.481.0000 |
| (4) 4CN.422.0000 |

I riferimenti normativi sono riferiti alle quote di installazione da pavimento, non alle altre distanze e alle tipologie di bagno.
The norms references refer to installation measurements from the floor and not to other distances and types of bathroom.
Les références normatives se réfèrent aux mesures d'installation du sol et pas à d'autres distances et types de salle de bain.
Las referencias normativas se refieren a las medidas de montaje desde suelo y no a otras distancias y tipos de baño.

SISTEMI DI FISSAGGIO - FIXING MATERIAL - SISTÈMES DE FIXATION - SISTEMAS DE FIJACIÓN

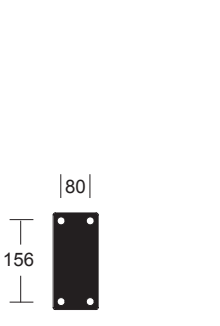

Art. 4CN.441.000P.xx
4CN.441.00PL.xx
4CN.441.00PLL.xx
4CN.441.00PA.xx
4CN.441.00PLA.xx
4CN.441.00PLLA.xx

Calcestruzzo e Pietra naturale - Concrete, Natural stone - Béton et Pierre naturelle - Hormigón y piedra natural

KIT 4CN.0VM.0001.00
In dotazione - Included
- Inclus - Includido:

- N°4 Fischer FU 10x60
- N°4 6,3x80
- N°4 bussola guida
guide bushes
douilles de guidage
casquillo guía

Mattone pieno e Mattone calcareo - Solid brick, Sand-lime brick - Brique pleine et brique calcaire - Ladrillo macizo y sílico calcáreo

KIT 4CN.0VM.0026.00 (INOX)
A pagamento - Extra -
En supplément - De pago:

- N°4 Fischer FUR 10x80SS
- N°4 7x85 INOX

Mattone forato - Hollow brick masonry - Brique creuse - Ladrillo hueco

KIT 4CN.0VM.0003.00
A pagamento - Extra -
En supplément - De pago:

- N°4 Fischer FIS H 20X85 K
- N°4 M10X30 INOX
- N°4 FIS E 15X85 M10

Cartongesso e legno stratificato - Plasterboard, Wooden plate - Placoplâtre - Panneau de bois lamellé - Panel de cartón yeso y madera laminada

KIT 4CN.0VM.0009.00
A pagamento - Extra -
En supplément - De pago:

- N°4 8x90
- N°4 bussola guida
guide bushes
douilles de guidage
casquillo guía

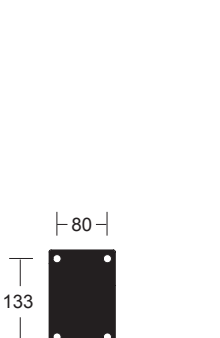

Art. 4CN.435.0000.xx.1
4CN.435.0000.xx.2

Calcestruzzo e Pietra naturale - Concrete, Natural stone - Béton et Pierre naturelle - Hormigón y piedra natural

KIT 4CN.0VM.0001.00
In dotazione - Included
- Inclus - Includido:

- N°4 Fischer FU 10x60
- N°4 6,3x80
- N°4 bussola guida
guide bushes
douilles de guidage
casquillo guía

Mattone pieno e Mattone calcareo - Solid brick, Sand-lime brick - Brique pleine et brique calcaire - Ladrillo macizo y sílico calcáreo

KIT 4CN.0VM.0001.00
In dotazione - Included
- Inclus - Includido:

- N°4 Fischer FU 10x60
- N°4 6,3x80
- N°4 bussola guida
guide bushes
douilles de guidage
casquillo guía

Mattone forato - Hollow brick masonry - Brique creuse - Ladrillo hueco

KIT 4CN.0VM.0003.00
A pagamento - Extra -
En supplément - De pago:

- N°4 Fischer FIS H 20X85 K
- N°4 M10X30 INOX
- N°4 FIS E 15X85 M10

Cartongesso e legno stratificato - Plasterboard, Wooden plate - Placoplâtre - Panneau de bois lamellé - Panel de cartón yeso y madera laminada

KIT 4CN.0VM.0009.00
A pagamento - Extra -
En supplément - De pago:

- N°4 8x90
- N°4 bussola guida
guide bushes
douilles de guidage
casquillo guía

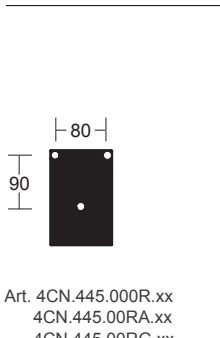

Art. 4CN.445.000R.xx
4CN.445.00RA.xx
4CN.445.00RG.xx
4CN.445.00RGA.xx
4CN.445.00RV.xx
4CN.445.00RE.xx
4CN.445.00RAE.xx
4CN.445.00RGE.xx
4CN.445.00RGO.xx

Calcestruzzo e Pietra naturale - Concrete, Natural stone - Béton et Pierre naturelle - Hormigón y piedra natural

KIT 4CN.0VM.0014.00
In dotazione - Included
- Inclus - Includido:

- N°3 Fischer FU 10x60
- N°3 6,3x80
- N°3 bussola guida
guide bushes
douilles de guidage
casquillo guía

Mattone pieno e Mattone calcareo - Solid brick, Sand-lime brick - Brique pleine et brique calcaire - Ladrillo macizo y sílico calcáreo

KIT 4CN.0VM.0015.00
A pagamento - Extra -
En supplément - De pago :

- N°3 Fischer FUR 10x80SS
- N°3 7x85

KIT 4CN.0VM.0029.00 (INOX)
A pagamento - Extra -
En supplément - De pago :

- N°3 Fischer FUR 10x80SS
- N°3 7x85 INOX

Mattone forato - Hollow brick masonry - Brique creuse - Ladrillo hueco

KIT 4CN.0VM.0016.00
A pagamento - Extra -
En supplément - De pago:

- N°3 Fischer FIS H 20X85 K
- N°3 M10X30 INOX
- N°3 FIS E 15X85 M10

Cartongesso e legno stratificato - Plasterboard, Wooden plate - Placoplâtre - Panneau de bois lamellé - Panel de cartón yeso y madera laminada

KIT 4CN.0VM.0017.00
A pagamento - Extra -
En supplément - De pago:

- N°3 8x90
- N°3 bussola guida
guide bushes
douilles de guidage
casquillo guía



Ausili con rosetta e Art. 4CN.447.000F.xx
4CN.447.00FT.xx

Disabled accessories with washer and Art. 4CN.447.000F.xx
4CN.447.00FT.xx

Barres de maintien avec rosace et Art. 4CN.447.000F.xx
4CN.447.00FT.xx

Asideros con roseta y Art. 4CN.447.000F.xx
4CN.447.00FT.xx

Calcestruzzo e Pietra naturale - Concrete, Natural stone - Béton et Pierre naturelle - Hormigón y piedra natural

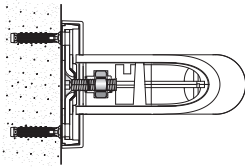

KIT 4CN.0VM.0004.00
In dotazione - Included
- Inclus - Includido:
N°3 Fischer SX8
N°3 5x60

Mattone pieno e Mattone calcareo - Solid brick, Sand-lime brick - Brique pleine et brique calcaire - Ladrillo macizo y sílico calcáreo

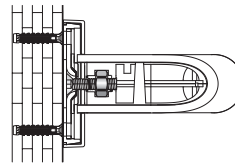

KIT 4CN.0VM.0004.00
In dotazione - Included
- Inclus - Includido:
N°3 Fischer SX8
N°3 5x60

Mattone forato - Hollow brick masonry - Brique creuse - Ladrillo hueco

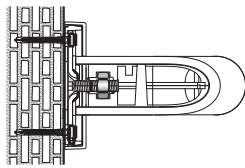

KIT 4CN.0VM.0005.00
A pagamento - Extra -
En supplément - De pago:
N°3 Fischer FUR 8x80T
KIT 4CN.0VM.0027.00 (INOX)
A pagamento - Extra -
En supplément - De pago:
N°3 Fischer FUR 8x80T INOX

Cartongesso e legno stratificato - Plasterboard, Wooden plate - Placoplâtre - Panneau de bois lamellé - Panel de cartón yeso y madera laminada

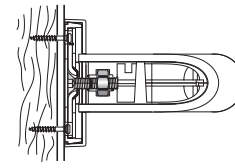

KIT 4CN.0VM.0010.00
A pagamento - Extra -
En supplément - De pago:
N°3 6x80

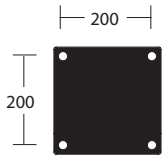

Art. 4CN.447.0000.xx
4CN.447.000B.xx
4CN.447.00CM.xx
4CN.447.00BS.xx
4CN.447.00BL.xx

Calcestruzzo e Pietra naturale - Concrete, Natural stone - Béton et Pierre naturelle - Hormigón y piedra natural

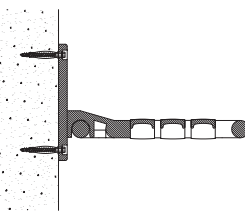

KIT 4CN.0VM.0001.00
In dotazione - Included
- Inclus - Includido:
N°4 Fischer FU 10x60
N°4 6,3x80
N°4 bussole guida
guide bushes
douilles de guidage
casquillo guía

Mattone pieno e Mattone calcareo - Solid brick, Sand-lime brick - Brique pleine et brique calcaire - Ladrillo macizo y sílico calcáreo

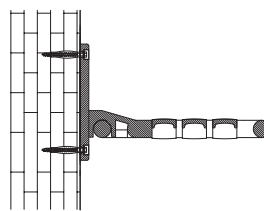

KIT 4CN.0VM.0001.00
In dotazione - Included
- Inclus - Includido:
N°4 Fischer FU 10x60
N°4 6,3x80
N°4 bussole guida
guide bushes
douilles de guidage
casquillo guía

Mattone forato - Hollow brick masonry - Brique creuse - Ladrillo hueco

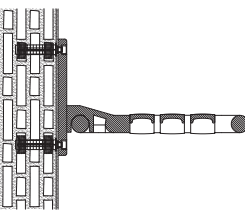

KIT 4CN.0VM.0003.00
A pagamento - Extra -
En supplément - De pago:
N°4 Fischer FIS H 20X85 K
N°4 M10X30 INOX
N°4 FIS E 15X85 M10

Cartongesso e legno stratificato - Plasterboard, Wooden plate - Placoplâtre - Panneau de bois lamellé - Panel de cartón yeso y madera laminada

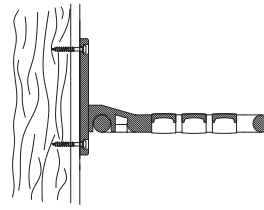

KIT 4CN.0VM.0009.00
A pagamento - Extra -
En supplément - De pago:
N°4 8x90
N°4 bussole guida
guide bushes
douilles de guidage
casquillo guía

Calcestruzzo e Pietra naturale - Concrete, Natural stone - Béton et Pierre naturelle - Hormigón y piedra natural

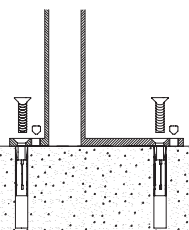

KIT 4CN.0VM.0006.00
A pagamento - Extra -
En supplément - De pago:
N°3 Fischer TAM 10
N°3 M10x90 INOX
KIT 4CN.0VM.0028.00 (INOX)
A pagamento - Extra -
En supplément - De pago:
N°3 Fischer TAM 10 INOX
N°3 M10x90 INOX

Mattone pieno e Mattone calcareo - Solid brick, Sand-lime brick - Brique pleine et brique calcaire - Ladrillo macizo y sílico calcáreo

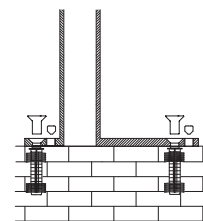

KIT 4CN.0VM.0007.00
A pagamento - Extra -
En supplément - De pago:
N°3 Fischer FIS H 20X85 K
N°3 M10X50 INOX
N°3 FIS E 15X85 M10

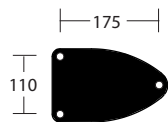

Art. 4CN.445.0RPT.xx
4CN.445.00RP.xx
4CN.445.0RPL.xx
4CN.45Y.0RPT.xx
4CN.45Y.00RP.xx
4CN.45Y.0RPL.xx
4CN.445.RPTA.xx
4CN.445.0RPA.xx
4CN.445.RPLA.xx
4CN.45Y.RPTA.xx
4CN.45Y.0RPA.xx
4CN.45Y.RPLA.xx

Mattone forato - Hollow brick masonry - Brique creuse - Ladrillo hueco

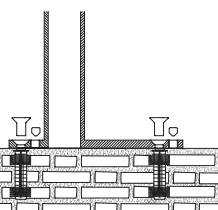

KIT 4CN.0VM.0007.00
A pagamento - Extra -
En supplément - De pago:
N°3 Fischer FIS H 20X85 K
N°3 M10X50 INOX
N°3 FIS E 15X85 M10

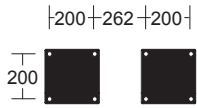

Art. 4CN.447.00BD.xx.1
4CN.447.00BD.xx.2

Calcestruzzo e Pietra naturale - Concrete, Natural stone - Béton et Pierre naturelle - Hormigón y piedra natural

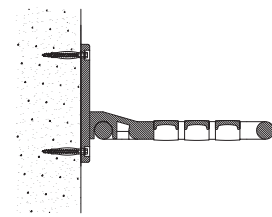

2 KIT 4CN.0VM.0001.00
In dotazione - Included
- Inclus - Includido:

- N°8 Fischer FU 10x60
- N°8 6,3x80
- N°8 bussola guida
guide bushes
douilles de guidage
casquillo guía

Mattone pieno e Mattone calcareo - Solid brick, Sand-lime brick - Brique pleine et brique calcaire - Ladrillo macizo y sílico calcáreo

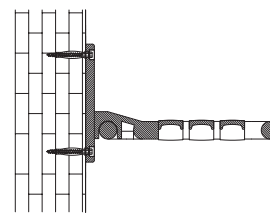

2 KIT 4CN.0VM.0001.00
In dotazione - Included
- Inclus - Includido:

- N°8 Fischer FU 10x60
- N°8 6,3x80
- N°8 bussola guida
guide bushes
douilles de guidage
casquillo guía

Mattone forato - Hollow brick masonry - Brique creuse - Ladrillo hueco

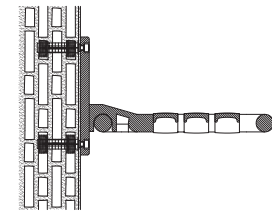

2 KIT 4CN.0VM.0003.00
A pagamento - Extra -
En supplément - De pago:

- N°8 Fischer FIS H 20X85 K
- N°8 M10X30 INOX
- N°8 FIS E 15X85 M10

Cartongesso e legno stratificato - Plasterboard, Wooden plate - Placoplâtre - Panneau de bois lamellé - Panel de cartón yeso y madera laminada

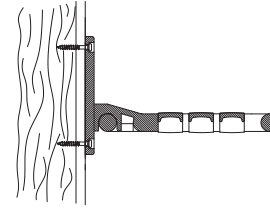

2 KIT 4CN.0VM.0009.00
A pagamento - Extra -
En supplément - De pago:

- N°8 8x90
- N°8 bussola guida
guide bushes
douilles de guidage
casquillo guía



Art. 4CN.448.0000.xx
4CN.448.000B.xx

Calcestruzzo e Pietra naturale - Concrete, Natural stone - Béton et Pierre naturelle - Hormigón y piedra natural

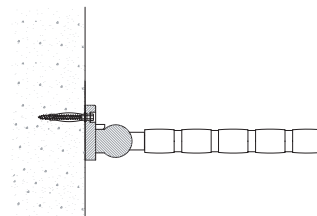

KIT 4CN.0VM.0001.00
In dotazione - Included
- Inclus - Includido:

- N°4 Fischer FU 10x60
- N°4 6,3x80
- N°4 bussola guida
guide bushes
douilles de guidage
casquillo guía

Mattone pieno e Mattone calcareo - Solid brick, Sand-lime brick - Brique pleine et brique calcaire - Ladrillo macizo y sílico calcáreo

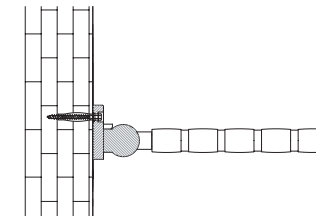

KIT 4CN.0VM.0001.00
In dotazione - Included
- Inclus - Includido:

- N°4 Fischer FU 10x60
- N°4 6,3x80
- N°4 bussola guida
guide bushes
douilles de guidage
casquillo guía

Mattone forato - Hollow brick masonry - Brique creuse - Ladrillo hueco

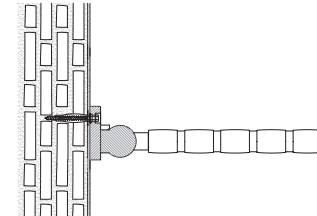

KIT 4CN.0VM.0001.00
In dotazione - Included
- Inclus - Includido:

- N°4 Fischer FU 10x60
- N°4 6,3x80
- N°4 bussola guida
guide bushes
douilles de guidage
casquillo guía

Calcestruzzo e Pietra naturale - Concrete, Natural stone - Béton et Pierre naturelle - Hormigón y piedra natural

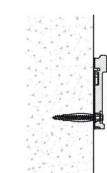

KIT 4CN.0VM.0014.00
In dotazione - Included
- Inclus - Includido:

- N°3 Fischer FU 10x60
- N°3 6,3x80
- N°3 bussola guida
guide bushes
douilles de guidage
casquillo guía

Mattone pieno e Mattone calcareo - Solid brick, Sand-lime brick - Brique pleine et brique calcaire - Ladrillo macizo y sílico calcáreo

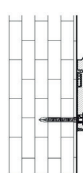

KIT 4CN.0VM.0015.00
A pagamento - Extra - En
supplément - De pago:

- N°3 Fischer FUR 10x80SS
 - N°3 7x85
- KIT 4CN.0VM.0029.00 (INOX)
A pagamento - Extra - En
supplément - De pago:
- N°3 Fischer FUR 10x80SS INOX
 - N°3 7x85

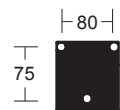

Art. 4CN.445.0CPM.00

Mattone forato - Hollow brick masonry - Brique creuse - Ladrillo hueco

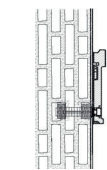

KIT 4CN.0VM.0016.00
A pagamento - Extra - En
supplément - De pago:

- N°3 Fischer FIS H 20X85 K
- N°3 M10X30 INOX
- N°3 FIS E 15X85 M10

Cartongesso e legno stratificato - Plasterboard, Wooden plate - Placoplâtre - Panneau de bois lamellé - Panel de cartón yeso y madera laminada

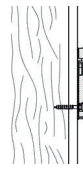

KIT 4CN.0VM.0017.00
A pagamento - Extra - En
supplément - De pago:

- N°3 8x90
- N°3 bussola guida
guide bushes
douilles de guidage
casquillo guía

NOTA: PER FISSAGGI SU ALTRI MATERIALI E PER LO SPESSORE MINIMO DEL LEGNO DA UTILIZZARE COME RINFORZO DEL CARTONGESSO, RIVOLGERSI ALL'UFFICIO TECNICO pba.
NOTE: FOR FIXING ON OTHER MATERIALS AND FOR THE MINIMUM THICKNESS OF THE WOOD REINFORCEMENT FOR PLASTERBOARD, PLEASE CONTACT pba TECHNICAL DEPT.
REMARQUE: POUR FIXATION SUR D'AUTRES MATÉRIAUX ET POUR L'ÉPAISSEUR MINIMUM DU BOIS À UTILISER COMME RENFORCEMENT DANS LE PLACOPLÂTRE, CONTACTEZ LE SERVICE TECHNIQUE pba.
NOTA: PARA FIJAR EN OTROS MATERIALES Y PARA EL ESPESOR MÍNIMO DE LA MADERA QUE HAY QUE UTILIZAR COMO REFUERZO DEL PANEL DE CARTÓN YESO, CONTACTEN EL DEPARTAMENTO TÉCNICO pba.

Per le etichette energetiche degli apparecchi di illuminazione: www.pba.it
For the Energy Labels of the illumination instruments see our website: www.pba.it
Pour l'étiquette-énergie des nos appareils d'éclairage voir le site: www.pba.it
Para las etiquetas energéticas de los dispositivos de iluminación: www.pba.it

ANTISUICIDE

CARICHI REGOLABILI (Art. 4CN.436.XXXX .xx)

La resistenza al carico dei singoli agganci del reggitenda è regolabile da pba S.p.A. secondo le specifiche d'ordine. La resistenza al carico nel punto centrale, tra due punti di fissaggio (F), equivale alla somma delle resistenze dei singoli punti di fissaggio.
 $5 \text{ kg} \leq F \leq 30 \text{ kg}$

ADJUSTABLE LOAD RESISTANCE (Art. 4CN.436.XXXX .xx)

The load resistance of each ceiling support is adjustable by pba S.p.A. according to customer specifications. The load resistance at midpoint between two ceiling supports (F) is equal to the sum of the load resistance of each ceiling support.
 $5 \text{ kg} \leq F \leq 30 \text{ kg}$

CHARGES RÉGLABLES (Art. 4CN.436.XXXX .xx)

La résistance de charge de chaque support plafond est réglable par pba S.p.A selon les spécifications du client. La résistance de charge au milieu, entre deux supports plafond (F) est égal à la somme de la résistance de chaque support plafond.
 $5 \text{ kg} \leq F \leq 30 \text{ kg}$

CARGAS AJUSTABLES (Art. 4CN.436.XXXX .xx)

La resistencia a la carga de cada soporte de techo de las barras de cortina es ajustable por pba S.p.A. de acuerdo con las especificaciones del cliente. La resistencia a la carga en el punto central, entre dos puntos de fijación (F), es igual a la suma de las resistencias de cada punto de fijación. $5 \text{ kg} \leq F \leq 30 \text{ kg}$

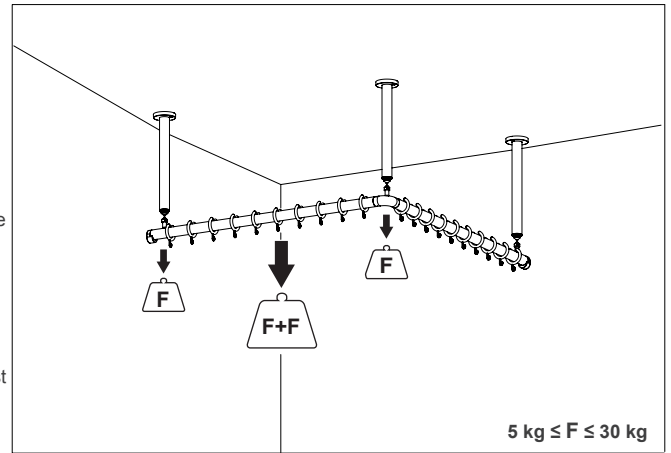

ARTICOLI RIAGGANCIABILI

I reggitenda e i ganci appendiabiti dopo lo sgancio sono facilmente riagganciabili



ARTICLES RACCROCHABLES

Les barres de rideau et les patères se raccrochent facilement en cas de déclenchement.



REATTACHABLE ITEMS

The shower curtain rails and the cloth hooks are easy to be refastened in case of release.



ARTÍCULOS REENGANCHABLES

Las barras de cortina y las perchas se pueden fácilmente reenganchar después del desenganche



ANCORAGGIO ANTICADUTA (Art. 4CN.436.XXXX .xx)

I reggitenda 4CN.436.XXXX.xx sono stati progettati per evitare la caduta a terra della barra dopo lo sgancio.

FIXATION POUR PRÉVENTION DES CHUTES (Art. 4CN.436.XXXX .xx)

Les barres de rideau 4CN.436.XXXX.xx ont été conçues pour empêcher la chute de la barre au sol après le déclenchement.

SECURITY FALL PREVENTION FIXING (Art. 4CN.436.XXXX .xx)

The curtain rails 4CN.436.XXXX.xx have been designed to avoid the rail to falling on the floor in case of release.

FIJACIÓN PARA PREVENCIÓN DE CAÍDAS (Art. 4CN.436.XXXX .xx)

Las barras de cortina 4CS.436.XXXX.xx se han proyectado para evitar la caída al suelo de la barra después del desenganche.

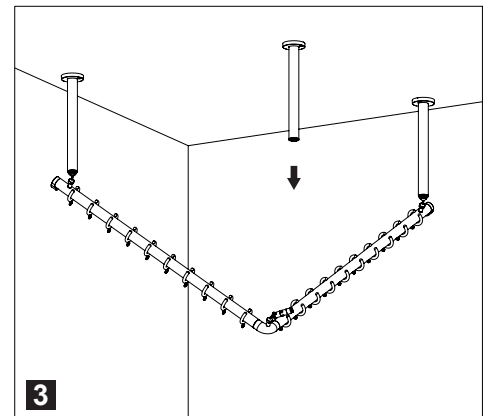
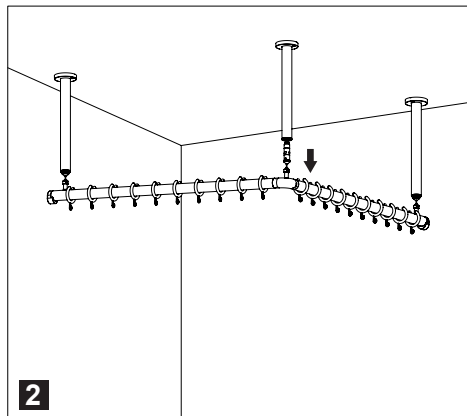
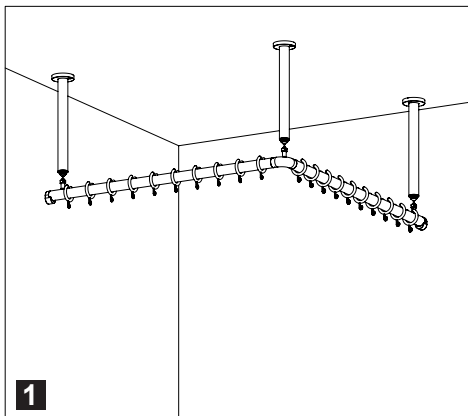

CERTIFICATO TÜV - TÜV CERTIFICATE
CERTIFICAT TÜV - CERTIFICACIÓN TÜV



Certificate N° : Z1 029615 0021

CONFORMITÀ CE - CE CONFORMITY
CONFORMITÉ CE - CONFORMIDAD CE



Regulation UE 2017/745
Directive 2014/35/UE

TEST CITOTOSSICITÀ - CITOTOXICITY TEST
TEST DE CYTOTOXICITÉ
PRUEBA DE CITOTOXICIDAD

Cytotoxicity test to DIN EN ISO 10993-5

MATERIALI - MATERIALS - MATÉRIAUX - MATERIALES

ALUMINUM EN-AW 6060

La lega di alluminio 6060 è una lega a media resistenza con un livello leggermente più basso rispetto alla lega 6005A. Ha un'ottima resistenza alla corrosione, ottima saldabilità e buona resistenza alle basse temperature. È comunemente usata per realizzare elementi anche con forma complessa e risulta molto buona nei processi di anodizzazione.

The aluminum 6060 alloy has an excellent resistance to corrosion, to low temperatures and allows quality weldings. In the design world it is commonly used to create components with complex shapes allowing excellent quality results compared to other alloys for anodizing treatments.

L'alliage d'aluminium 6060 est un alliage pouvant être traité thermiquement de résistance moyenne, avec une résistance légèrement inférieure à l'alliage 6005A. Il présente une très bonne résistance à la corrosion, une très bonne soudabilité et une bonne formabilité à froid. Il est couramment utilisé pour les sections complexes et présente une très bonne réponse au processus d'anodisation.

La aleación de aluminio 6060 es una aleación que se puede tratar con calor de resistencia media, ligeramente inferior a 6005A. Tiene muy buena resistencia a la corrosión, muy buena soldabilidad y buena conformabilidad en frío. Se usa comúnmente para cortes transversales complejos y tiene una respuesta de anodización muy buena.

Alloy	Forms	Characteristics - Properties	Applications
EN - AW 6060	• Extruded round rod/bar	• Very good corrosion resistance • Medium strength • Complex sections • Anodizing quality	Architectural sections, frames, lightings, railing, ladders, furniture, fences, flooring

Alloy	Temper	Temper designation (EN 515)
EN - AW 6060	O	Annealed wrought alloys
	T4	Solution heat treated & natural aged
	T5	Cooled from an elevated temperature forming operation & artificially aged (precipitation hardened)
	T6	Solution heat treated & artificially aged (precipitation hardened) Press quenching required
	T64	Solution heat treated & artificially aged (precipitation hardened) Under aged to improve formability (bending temper)
T66	Cooled from an elevated temperature forming operation & artificially aged (precipitation hardened) to a higher level of mechanical properties through special control of manufacturing processes. Press quenching required.	

REGISTRAZIONE MODELLI - REGISTERED MODELS -
MODÈLES ENREGISTRÉS - REGISTRACIÓN MODELOS

I modelli del Programma 400-ALU sono stati registrati con domanda di brevetto numero 002497834.

All Programma 400-ALU models are registered with application number 002497834.

Tous les modèles Programma 400-ALU ont été enregistrés avec la demande de brevet numéro 002497834.

Les modelos del Programma 400-ALU se registraron con solicitud de patente número 002497834.

PULIZIA - MAINTENANCE - NETTOYAGE - LIMPIEZA

HCl
 Muriatic acid
 HF
 Chlorine water / Bleaching solution
 Neutral PH

ELEMENTI COSTRUTTIVI - STRUCTURAL ELEMENTS -
ELEMENTS CONSTRUCTIFS - ELEMENTOS CONSTRUCTIVOS



ALUMINUM COMPONENTS
ARE COMPLETELY
SEPARABLE FOR RECYCLE

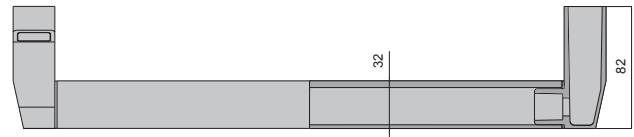

ELEMENTO RETTILINEO

Profilo in alluminio estruso lega EN AW-6060 anodizzato (HB=80MIN)

STRAIGHT ELEMENT

Extruded alloy EN AW-6060 aluminum tube anodized (HB=80MIN)

ÉLÉMENT RECTILIGNE

Tube en aluminium extrudé alliage EN AW-6060 anodisé (HB=80MIN)

ELEMENTO RECTILÍNEO

Perfil de aluminio extruido aleación EN AW-6060 anodizado (HB=80MIN)



ELEMENTO CURVO A 90°

Curva in alluminio pressofuso con cataforesi e verniciatura

90° BEND

Die-cast aluminum bend with cathaphoresis treatment and powder-coating

ÉLÉMENT CINTRÉ À 90°

Coude en aluminium moulé sous pression avec traitement de cathaphorèse et revêtement en poudre

ELEMENTO CURVO EN ÁNGULO DE 90°

Codo de aluminio moldeado a presión con cataforesi y recubrimiento en polvo

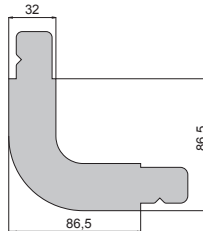

SUPPORTO A MURO

Supporto in lega di zinco (ZAMAK) con cataforesi e verniciatura

WALL SUPPORT

Zinc alloy support (ZAMAK) with cathaphoresis treatment and powder-coating

SUPPORT MURAL

Support en alliage de zinc (ZAMAK) avec traitement de cathaphorèse et revêtement en poudre

SOPORTE DE PARED

Soporte de aleación de zinc (ZAMAK) con cataforesi y recubrimiento en polvo

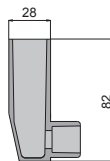

SUPPORTO DRITTO

Supporto in lega di zinco (ZAMAK) con cataforesi e verniciatura

STRAIGHT SUPPORT

Zinc alloy support (ZAMAK) with cathaphoresis treatment and powder-coating

SUPPORT DROIT

Support en alliage de zinc (ZAMAK) avec traitement de cathaphorèse et revêtement en poudre

SOPORTE RECTO

Soporte de aleación de zinc (ZAMAK) con cataforesi y recubrimiento en polvo

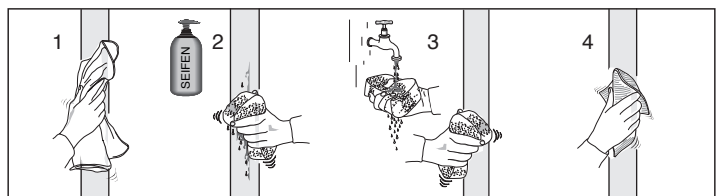
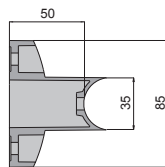

GUIDA AL PROGETTO - GUIDE TO THE PROJECT - DESCRIPTIF PROJET - GUÍA PARA EL PROYECTO

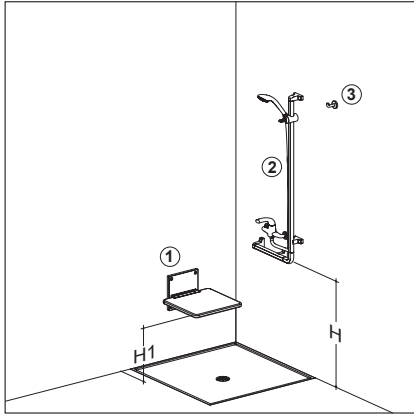

- ① 4CN.447.00CM ② 4CA.22J.00LA ③ 4CN.488.000P

(D)	DIN 18040-1 DIN 18040-2	H= 850	H1= 460/480
(I)	DM 236 14/06/1989	H= 800	H1= 450/500
(GB)	APPROVED DOCUMENT M	H= 680	H1= 480
(A)	Ö - NORM B 1600	H= 750/850	H1= 460/480
(F)	JORF n°195 (24/08/2006) Text 14 AFNOR NF P 99-611	H= 700/800	H1= 450/500
(CH)	SIA 500	H= 700/750	H1= 460

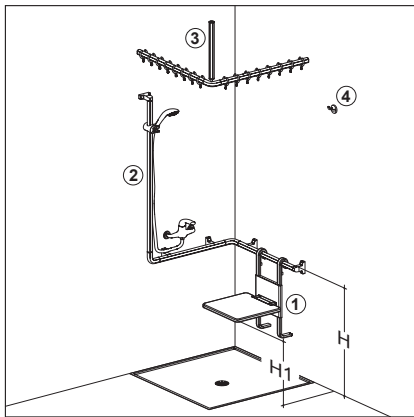

- ① 4CA.450.00CM ② 4CA.24J.00LA ③ 4CA.436.000B ④ 4CN.488.000P

(D)	DIN 18040-1 (4CA.450.0CML) DIN 18040-2 (4CA.450.0CML)	H= 850	H1= 480
(I)	DM 236 14/06/1989 (4CA.450.00CM)	H= 800	H1= 500
(GB)	APPROVED DOCUMENT M	H= 680	H1= -
(A)	Ö - NORM B 1600 (4CA.450.00CM) (4CA.450.0CML)	H= 760/780 H= 830/850	H1= 460/480 H1= 460/480
(F)	JORF n°195 (24/08/2006) Text 14 AFNOR NF P 99-611 (4CA.450.00CM)	H= 750/800	H1= 450/500
(CH)	SIA 500	H= 700/750	H1= 460

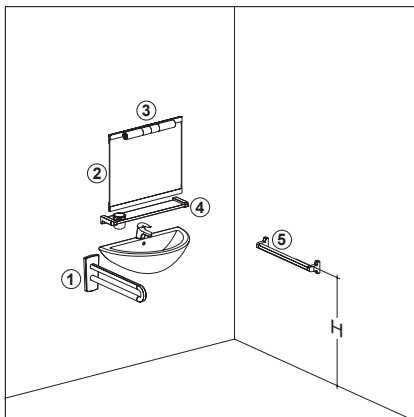

- ① 4CA.441.000P ② 4CA.470.0000 ③ 4CN.407.0TUA ④ 4CA.485.00AL ⑤ 4CA.440.000A

(D)	DIN 18040-1 DIN 18040-2	H= 850
(I)	DM 236 14/06/1989	H= 800
(GB)	APPROVED DOCUMENT M	H= 680
(A)	Ö - NORM B 1600	H= 750
(F)	JORF n°195 (24/08/2006) Text 14 AFNOR NF P 99-611	H= 700/800
(CH)	SIA 500	H= 700/750

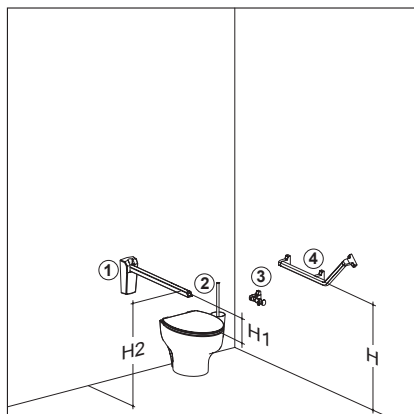

- ① 4CA.445.0000 ② 4CA.486.000C ③ 4CA.481.0000 ④ 4CA.427.0000

(D)	DIN 18040-1 DIN 18040-2	H= 850	H1= 280	H2= 740/760
(I)	DM 236 14/06/1989	H= 800	H1= -	H2= 800
(GB)	APPROVED DOCUMENT M	H= 680	H1= -	H2= 680
(A)	Ö - NORM B 1600	H= 750	H1= -	H2= 750
(F)	JORF n°195 (24/08/2006) Text 14 AFNOR NF P 99-611	H= 700/800	H1= -	H2= 700/800
(CH)	SIA 500	H= 700/750	H1= 290	H2= 700/750

I riferimenti normativi sono riferiti alle quote di installazione da pavimento, non alle altre distanze e alle tipologie di bagno.
 The norms references refer to installation measurements from the floor and not to other distances and types of bathroom.
 Les références normatives se réfèrent aux mesures d'installation du sol et pas à d'autres distances et types de salle de bain.
 Las referencias normativas se refieren a las medidas de montaje desde suelo y no a otras distancias y tipos de baño.

SISTEMI DI FISSAGGIO - FIXING MATERIAL - SISTÈMES DE FIXATION - SISTEMAS DE FIJACIÓN

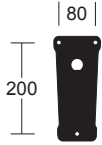

Art. 4CA.441.000P.xx
Art. 4CA.441.00PL.xx
Art. 4CA.441.0PLL.xx

Calcestruzzo e Pietra naturale - Concrete, Natural stone - Béton et Pierre naturelle - Hormigón y piedra natural

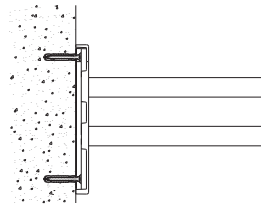

- KIT 4CN.0VM.0014.00**
In dotazione - Included
- Inclus - Includido:
- N°3 Fischer FU 10x60
 - N°3 6.3x80 INOX
 - N°3 bussole guida
guide bushes
douilles de guidage
casquillo guía

Mattone pieno e Mattone calcareo - Solid brick, Sand-lime brick - Brique pleine et brique calcaire - Ladrillo macizo y silico calcáreo

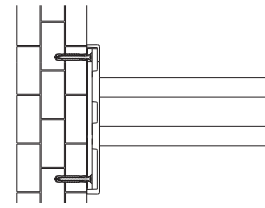

- KIT 4CN.0VM.0014.00**
In dotazione - Included
- Inclus - Includido:
- N°3 Fischer FU 10x60
 - N°3 6.3x80 INOX
 - N°3 bussole guida
guide bushes
douilles de guidage
casquillo guía

Mattone forato - Hollow brick masonry - Brique creuse - Ladrillo hueco

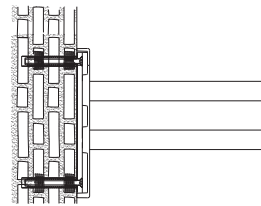

- KIT 4CN.0VM.0036.00**
A pagamento - Extra
- En supplément - De pago:
- N°3 Fischer FIS H 16x85 K
 - N°3 M8x25 INOX
 - N°3 FIS E 11x85 M8

Cartongesso e legno stratificato - Plasterboard, Wooden plate - Placoplâtre - Panneau de bois lamellé - Panel de cartón yeso y madera laminada

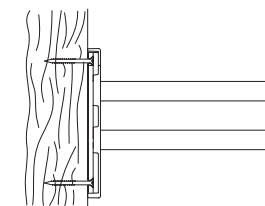

- KIT 4CN.0VM.0017.00**
A pagamento - Extra
- En supplément - De pago:
- N°3 8x80 INOX
 - N°3 bussole guida
guide bushes
douilles de guidage
geleidmof
casquillo guía

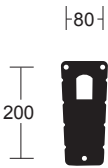

Art. 4CA.445.000T.xx
4CA.45Y.000T.xx
4CA.45K.000T.xx
4CA.445.0000.xx
4CA.45Y.0000.xx
4CA.45K.0000.xx
4CA.445.000L.xx
4CA.45Y.000L.xx
4CA.45K.000L.xx

Calcestruzzo e Pietra naturale - Concrete, Natural stone - Béton et Pierre naturelle - Hormigón y piedra natural

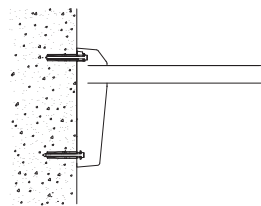

- KIT 4CN.0VM.0014.00**
In dotazione - Included
- Inclus - Includido:
- N°3 Fischer FU 10x60
 - N°3 6.3x80 INOX
 - N°3 bussole guida
guide bushes
douilles de guidage
führungsbuchse
casquillo guía

Mattone pieno e Mattone calcareo - Solid brick, Sand-lime brick - Brique pleine et brique calcaire - Ladrillo macizo y silico calcáreo

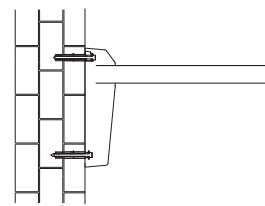

- KIT 4CN.0VM.0014.00**
In dotazione - Included
- Inclus - Includido:
- N°3 Fischer FU 10x60
 - N°3 6.3x80 INOX
 - N°3 bussole guida
guide bushes
douilles de guidage
führungsbuchse
casquillo guía

Mattone forato - Hollow brick masonry - Brique creuse - Ladrillo hueco

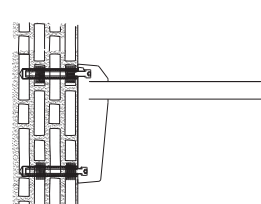

- KIT 4CN.0VM.0033.00**
A pagamento - Extra
- En supplément - De pago:
- N°3 Fischer FIS H 16x85 K
 - N°3 M8x30 INOX
 - N°3 FIS E 11x85 M8

Cartongesso e legno stratificato - Plasterboard, Wooden plate - Placoplâtre - Panneau de bois lamellé - Panel de cartón yeso y madera laminada

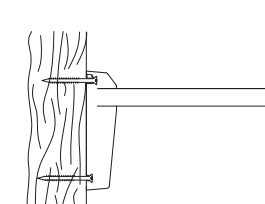

- KIT 4CN.0VM.0034.00**
A pagamento - Extra
- En supplément - De pago:
- N°3 8x90 INOX

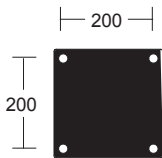

Art. 4CN.447.00CM.xx
4CN.47K.00CM.xx

Calcestruzzo e Pietra naturale - Concrete, Natural stone - Béton et Pierre naturelle - Hormigón y piedra natural

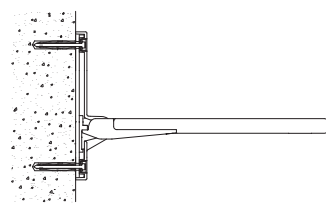

- KIT 4CN.0VM.0001.00**
In dotazione - Included
- Inclus - Includido:
- N°4 Fischer FU 10x60
 - N°4 6.3x80 INOX
 - N°4 bussole guida
guide bushes
douilles de guidage
casquillo guía

Mattone pieno e Mattone calcareo - Solid brick, Sand-lime brick - Brique pleine et brique calcaire - Ladrillo macizo y silico calcáreo

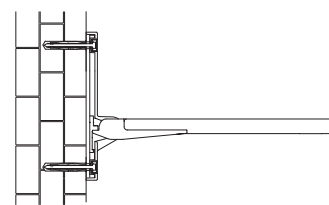

- KIT 4CN.0VM.0001.00**
In dotazione - Included
- Inclus - Includido:
- N°4 Fischer FU 10x60
 - N°4 6.3x80 INOX
 - N°4 bussole guida
guide bushes
douilles de guidage
casquillo guía

Mattone forato - Hollow brick masonry - Brique creuse - Ladrillo hueco

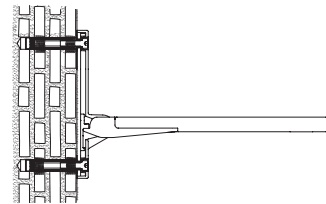

- KIT 4CN.0VM.0003.00**
A pagamento - Extra
- En supplément - De pago:
- N°4 Fischer FIP 20x85R
 - N°4 M10x30 INOX
 - N°4 FIP 14x80 M10i

Cartongesso e legno stratificato - Plasterboard, Wooden plate - Placoplâtre - Panneau de bois lamellé - Panel de cartón yeso y madera laminada

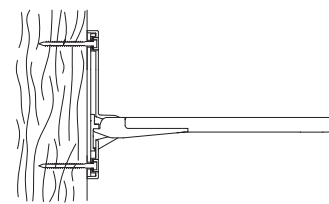

- KIT 4CN.0VM.0009.00**
A pagamento - Extra
- En supplément - De pago:
- N°4 8x90 INOX
 - N°4 bussole guida
guide bushes
douilles de guidage
führungsbuchse
casquillo guía

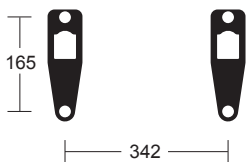

Art. 4CA.451.000B.xx



Ausili
Disabled
Accessories Barres
de maintien
Asideros

Calcestruzzo e Pietra naturale - Concrete, Natural stone - Béton et Pierre naturelle - Hormigón y piedra natural

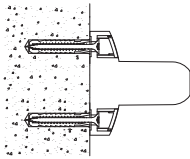

KIT 4CN.VM.0030.00
In dotazione - Included
- Inclus - Includido:

- N°2 Fischer SX10
- N°2 6x70 INOX
- N°2 bussola guida
guide bushes
douilles de guidage
casquillo guía

Mattone pieno e Mattone calcareo - Solid brick, Sand-lime brick - Brique pleine et brique calcaire - Ladrillo macizo y sílico calcáreo

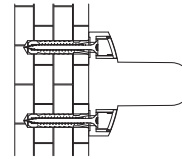

KIT 4CN.VM.0030.00
In dotazione - Included
- Inclus - Includido:

- N°2 Fischer SX10
- N°2 6x70 INOX
- N°2 bussola guida
guide bushes
douilles de guidage
casquillo guía

Mattone forato - Hollow brick masonry - Brique creuse - Ladrillo hueco

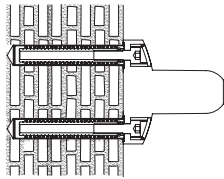

KIT 4CN.0VM.0031.00
A pagamento - Extra -
En supplément - De pago:

- N°2 Fischer FIS H 16X85 K
- N°2 M8X30 INOX
- N°2 FIS E 11X85 M8
- N°2 bussola guida
guide bushes
douilles de guidage
casquillo guía

Cartongesso e legno stratificato - Plasterboard, Wooden plate - Placoplâtre - Panneau de bois lamellé - Panel de cartón yeso y madera laminada

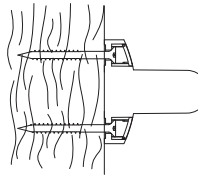

KIT 4CN.0VM.0032.00
A pagamento - Extra -
En supplément - De pago:

- N°2 8x80 INOX
- N°2 bussola guida
guide bushes
douilles de guidage
casquillo guía

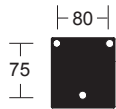

Art. 4CN.445.0CPM.00

Calcestruzzo e Pietra naturale - Concrete, Natural stone - Béton et Pierre naturelle - Hormigón y piedra natural

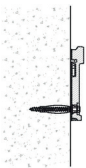

KIT 4CN.0VM.0014.00
In dotazione - Included
- Inclus - Includido:

- N°3 Fischer FU 10x60
- N°3 6,3x80
- N°3 bussola guida
guide bushes
douilles de guidage
casquillo guía

Mattone pieno e Mattone calcareo - Solid brick, Sand-lime brick - Brique pleine et brique calcaire - Ladrillo macizo y sílico calcáreo

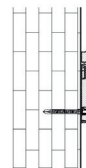

KIT 4CN.0VM.0015.00
A pagamento - Extra - En
supplément - De pago:

- N°3 Fischer FUR 10x80SS
- N°3 7x85

KIT 4CN.0VM.0029.00 (INOX)
A pagamento - Extra - En
supplément - De pago:

- N°3 Fischer FUR 10x80SS INOX
- N°3 7x85

Mattone forato - Hollow brick masonry - Brique creuse - Ladrillo hueco

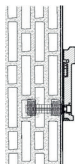

KIT 4CN.0VM.0016.00
A pagamento - Extra - En
supplément - De pago:

- N°3 Fischer FIS H 20X85 K
- N°3 M10X30 INOX
- N°3 FIS E 15X85 M10

Cartongesso e legno stratificato - Plasterboard, Wooden plate - Placoplâtre - Panneau de bois lamellé - Panel de cartón yeso y madera laminada

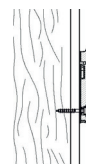

KIT 4CN.0VM.0017.00
A pagamento - Extra - En
supplément - De pago:

- N°3 8x90
- N°3 bussola guida
guide bushes
douilles de guidage
casquillo guía

NOTA: PER FISSAGGI SU ALTRI MATERIALI E PER LO SPESSORE MINIMO DEL LEGNO DA UTILIZZARE COME RINFORZO DEL CARTONGESSO, RIVOLGERSI ALL'UFFICIO TECNICO pba.
NOTE: FOR FIXING ON OTHER MATERIALS AND FOR THE MINIMUM THICKNESS OF THE WOOD REINFORCEMENT FOR PLASTERBOARD, PLEASE CONTACT pba TECHNICAL DEPT.
REMARQUE: POUR FIXATION SUR D'AUTRES MATÉRIAUX ET POUR L'ÉPAISSEUR MINIMUM DU BOIS À UTILISER COMME RENFORCEMENT DANS LE PLACOPLÂTRE, CONTACTEZ LE SERVICE TECHNIQUE pba.
NOTA: PARA FIJAR EN OTROS MATERIALES Y PARA EL ESPESOR MÍNIMO DE LA MADERA QUE HAY QUE UTILIZAR COMO REFUERZO DEL PANEL DE CARTÓN YESO, CONTACTEN EL DEPARTAMENTO TÉCNICO pba.

Per le etichette energetiche degli apparecchi di illuminazione: www.pba.it
For the Energy Labels of the illumination instruments see our website: www.pba.it
Pour l'étiquette-énergie des nos appareils d'éclairage voir le site: www.pba.it
Para las etiquetas energéticas de los dispositivos de iluminación: www.pba.it

CONFORMITÀ CE - CE CONFORMITY
CONFORMITÉ CE
CONFORMIDAD CE



Regulation UE 2017/745
Directive 2014/35/UE

MATERIALI - MATERIALS - MATÉRIAUX - MATERIALES

ALUMINUM EN-AW 6060

La lega di alluminio 6060 è una lega a media resistenza con un livello leggermente più basso rispetto alla lega 6005A. Ha un'ottima resistenza alla corrosione, ottima saldabilità e buona resistenza alle basse temperature. È comunemente usata per realizzare elementi anche con forma complessa e risulta molto buona nei processi di anodizzazione.

The aluminum 6060 alloy has an excellent resistance to corrosion, to low temperatures and allows quality weldings. In the design world it is commonly used to create components with complex shapes allowing excellent quality results compared to other alloys for anodizing treatments.

L'alliage d'aluminium 6060 est un alliage pouvant être traité thermiquement de résistance moyenne, avec une résistance légèrement inférieure à l'alliage 6005A. Il présente une très bonne résistance à la corrosion, une très bonne soudabilité et une bonne formabilité à froid. Il est couramment utilisé pour les sections complexes et présente une très bonne réponse au processus d'anodisation.

La aleación de aluminio 6060 es una aleación que se puede tratar con calor de resistencia media, ligeramente inferior a 6005A. Tiene muy buena resistencia a la corrosión, muy buena soldabilidad y buena conformabilidad en frío. Se usa comúnmente para cortes transversales complejos y tiene una respuesta de anodización muy buena.

Alloy	Forms	Characteristics - Properties	Applications
EN - AW 6060	• Extruded round rod/bar	• Very good corrosion resistance • Medium strength • Complex sections • Anodising quality	Architectural sections, frames, lightings, railing, ladders, furniture, fences, flooring

Alloy	Temper	Temper designation (EN 515)
EN - AW 6060	O	Annealed wrought alloys
	T4	Solution heat treated & natural aged
	T5	Cooled from an elevated temperature forming operation & artificially aged (precipitation hardened)
	T6	Solution heat treated & artificially aged (precipitation hardened) Press quenching required
	T64	Solution heat treated & artificially aged (precipitation hardened) Under aged to improve formability (bending temper)
T66	Cooled from an elevated temperature forming operation & artificially aged (precipitation hardened) to a higher level of mechanical properties through special control of manufacturing processes. Press quenching required.	

REGISTRAZIONE MODELLI - REGISTERED MODELS - MODÈLES ENREGISTRÉS - REGISTRACIÓN MODELOS

I modelli del Programma CAP sono stati registrati con domanda di brevetto numero 0087324.

All Programma CAP models are registered with application number 0087324.

Tous les modèles Programma CAP ont été enregistrés avec la demande de brevet numéro 0087324.

Los modelos del Programma CAP se registraron con solicitud de patente número 0087324.

PULIZIA - MAINTENANCE - NETTOYAGE - LIMPIEZA

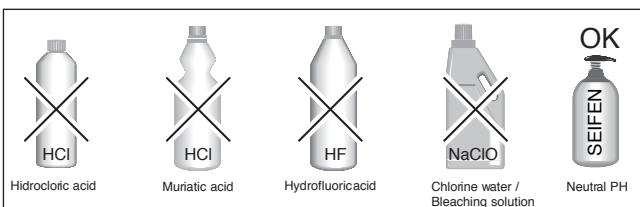

ELEMENTI COSTRUTTIVI - STRUCTURAL ELEMENTS - ELEMENTS CONSTRUCTIFS - ELEMENTOS CONSTRUCTIVOS



ALUMINUM COMPONENTS ARE COMPLETELY SEPARABLE FOR RECYCLE

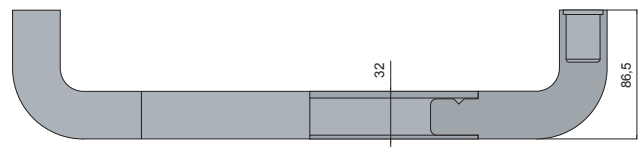

ELEMENTO RETTILINEO

Profilo in alluminio estruso lega EN AW-6060

STRAIGHT ELEMENT

Extruded alloy EN AW-6060 aluminum tube

ÉLÉMENT RECTILIGNE

Tube en aluminium extrudé alliage EN AW-6060

ELEMENTO RECTILÍNEO

Perfil de aluminio extruido aleación EN AW-6060



ELEMENTO CURVO A 90°

Curva in alluminio pressofuso

90° BEND

Die-cast aluminum bend

ÉLÉMENT CINTRÉ À 90°

Coude en aluminium moulé sous pression

ELEMENTO CURVO EN ÁNGULO DE 90°

Codo de aluminio moldeado a presión

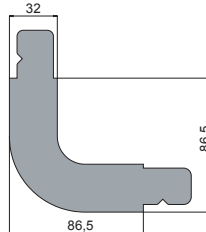

ELEMENTO CURVO TERMINALE A 90°

90° WALL BEND

ÉLÉMENT TERMINAL À ANGLE 90°

ELEMENTO TERMINAL DE PARED EN ÁNGULO A 90°

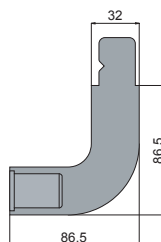

SUPPORTO DRITTO

Supporto in alluminio pressofuso

STRAIGHT SUPPORT

Die-cast aluminum moulded bend

SUPPORT DROIT

Support en aluminium moulé sous pression

SOPORTE RECTO

Soporte de aluminio moldeado a presión

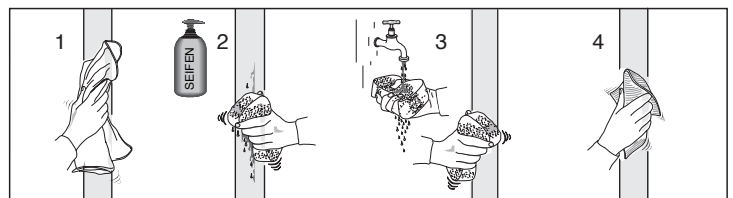
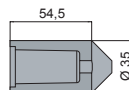

GUIDA AL PROGETTO - GUIDE TO THE PROJECT - DESCRIPTIF PROJET - GUÍA PARA EL PROYECTO

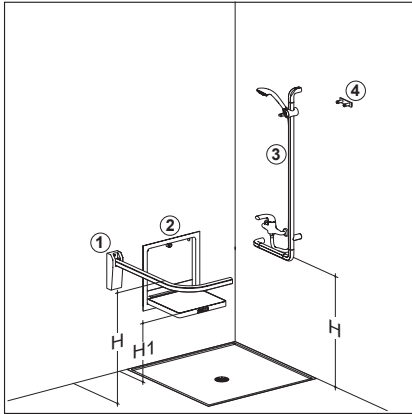

① CAP.435.0000	② CAP.447.000B	③ CAP.22J.0000	④ CAP.488.0000		
(D) DIN 18040-1 DIN 18040-2				H= 850	H1= 460/480
(I) DM 236 14/06/1989				H= 800	H1= 450/500
(GB) APPROVED DOCUMENT M				H= 680	H1= 480
(A) Ö - NORM B 1600				H= 750/850	H1= 460/480
(F) JORF n°195 (24/08/2006) Text 14 AFNOR NF P 99-611				H= 700/800	H1= 450/500
(CH) SIA 500				H= 700/750	H1= 460

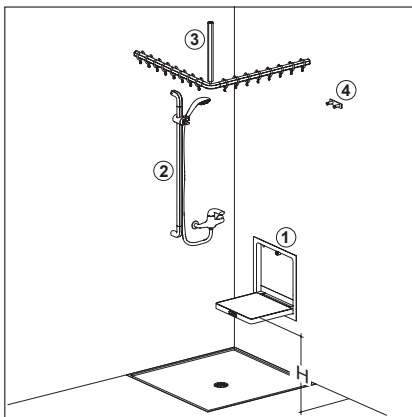

① CAP.447.000B	② CAP.487.0000	③ CAP.436.000B	④ CAP.488.0000		
(D) DIN 18040-1 DIN 18040-2				H= 460/480	
(I) DM 236 14/06/1989				H= 450/500	
(GB) APPROVED DOCUMENT M				H= 480	
(A) Ö - NORM B 1600				H= 460/480	
(F) JORF n°195 (24/08/2006) Text 14 AFNOR NF P 99-611				H= 450/500	
(CH) SIA 500				H= 460	

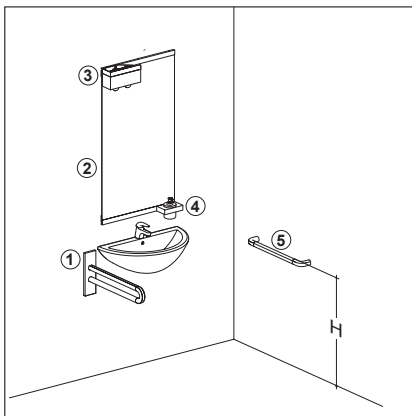

① CAP.441.000P	② CAP.490.0000	③ CAP.407.0000	④ CAP.483.000D	⑤ CAP.440.0000	
(D) DIN 18040-1 DIN 18040-2					H= 850
(I) DM 236 14/06/1989					H= 800
(GB) APPROVED DOCUMENT M					H= 680
(A) Ö - NORM B 1600					H= 750
(F) JORF n°195 (24/08/2006) Text 14 AFNOR NF P 99-611					H= 700/800
(CH) SIA 500					H= 700/750

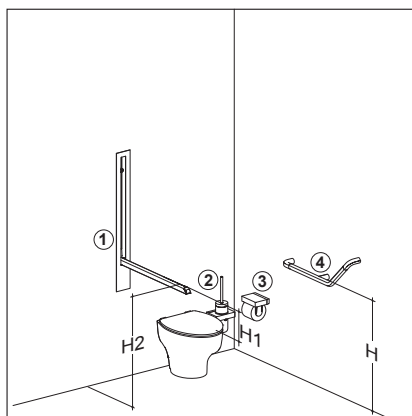

① CAP.445.0000	② CAP.486.0000	③ CAP.481.00BA	④ CAP.427.0000			
(D) DIN 18040-1 DIN 18040-2				H= 850	H1= 280	H2= 740/760
(I) DM 236 14/06/1989				H= 800	H1= -	H2= 800
(GB) APPROVED DOCUMENT M				H= 680	H1= -	H2= 680
(A) Ö - NORM B 1600				H= 750	H1= -	H2= 750
(F) JORF n°195 (24/08/2006) Text 14 AFNOR NF P 99-611				H= 700/800	H1= -	H2= 700/800
(CH) SIA 500				H= 700/750	H1= 290	H2= 700/750

I riferimenti normativi sono riferiti alle quote di installazione da pavimento, non alle altre distanze e alle tipologie di bagno.
 The norms references refer to installation measurements from the floor and not to other distances and types of bathroom.
 Les références normatives se réfèrent aux mesures d'installation du sol et pas à d'autres distances et types de salle de bain.
 Las referencias normativas se refieren a las medidas de montaje desde suelo y no a otras distancias y tipos de baño.

SISTEMI DI FISSAGGIO - FIXING MATERIAL - SISTÈMES DE FIXATION - SISTEMAS DE FIJACIÓN

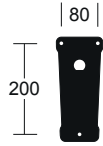

Art. CAP.441.000P. xx
Art. CAP.441.00PL. xx
Art. CAP.441.0PLL. xx

Calcestruzzo e Pietra naturale - Concrete, Natural stone - Béton et Pierre naturelle - Hormigón y piedra natural

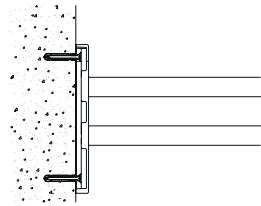

KIT 4CN.0VM.0014.00
In dotazione - Included
- Inclus - Includido:

- N°3 Fischer FU 10x60
- N°3 6,3x80 INOX
- N°3 bussola guida guide bushes douilles de guidage casquillo guía

Mattone pieno e Mattone calcareo - Solid brick, Sand-lime brick - Brique pleine et brique calcaire - Ladrillo macizo y sílico calcáreo

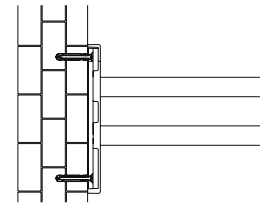

KIT 4CN.0VM.0014.00
In dotazione - Included
- Inclus - Includido:

- N°3 Fischer FU 10x60
- N°3 6,3x80 INOX
- N°3 bussola guida guide bushes douilles de guidage casquillo guía

Mattone forato - Hollow brick masonry - Brique creuse - Ladrillo hueco

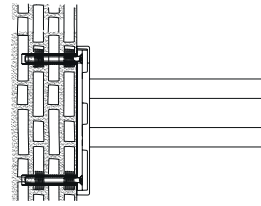

KIT 4CN.0VM.0033.00
A pagamento - Extra -
En supplément - De pago:

- N°3 Fischer FIS H 16X85 K
- N°3 M8X30 INOX
- N°3 FIS E 11X85 M8

Cartongesso e legno stratificato - Plasterboard, Wooden plate - Placoplâtre - Panneau de bois lamellé - Panel de cartón yeso y madera laminada

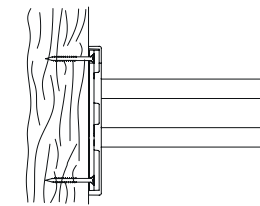

KIT 4CN.0VM.0017.00
A pagamento - Extra -
En supplément - De pago:

- N°3 8x90 INOX

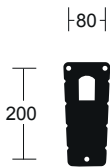

Art.
4CA.445.000T.xx
4CA.45Y.000T.xx
4CA.45K.000T.xx
4CA.445.0000.xx
4CA.45Y.0000.xx
4CA.45K.0000.xx
4CA.445.000L.xx
4CA.45Y.000L.xx
4CA.45K.000L.xx

Calcestruzzo e Pietra naturale - Concrete, Natural stone - Béton et Pierre naturelle - Hormigón y piedra natural

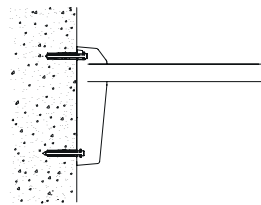

KIT 4CN.0VM.0014.00
In dotazione - Included
- Inclus - Includido:

- N°3 Fischer FU 10x60
- N°3 6,3x80 INOX
- N°3 bussola guida guide bushes douilles de guidage casquillo guía

Mattone pieno e Mattone calcareo - Solid brick, Sand-lime brick - Brique pleine et brique calcaire - Ladrillo macizo y sílico calcáreo

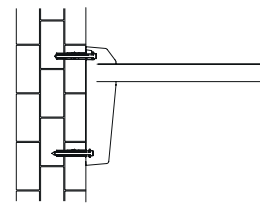

KIT 4CN.0VM.0014.00
In dotazione - Included
- Inclus - Includido:

- N°3 Fischer FU 10x60
- N°3 6,3x80 INOX
- N°3 bussola guida guide bushes douilles de guidage casquillo guía

Mattone forato - Hollow brick masonry - Brique creuse - Ladrillo hueco

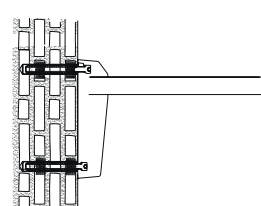

KIT 4CN.0VM.0033.00
A pagamento - Extra -
En supplément - De pago:

- N°3 Fischer FIS H 16X85 K
- N°3 M8X30 INOX
- N°3 FIS E 11X85 M8

Cartongesso e legno stratificato - Plasterboard, Wooden plate - Placoplâtre - Panneau de bois lamellé - Panel de cartón yeso y madera laminada

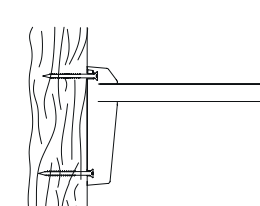

KIT 4CN.0VM.0034.00
A pagamento - Extra -
En supplément - De pago:

- N°3 8x90 INOX



Asili con rosetta e Art.
Disabled accessories
with washer and Art.
Barres de maintien avec
rosace et Art.
Asideros con roseta y Art.

CAP.429.0000.75
CAP.429.000A.75
CAP.429.000B.75
CAP.429.000C.75
CAP.429.000D.75
CAP.429.000E.75
CAP.429.9999.75

Calcestruzzo e Pietra naturale - Concrete, Natural stone - Béton et Pierre naturelle - Hormigón y piedra natural

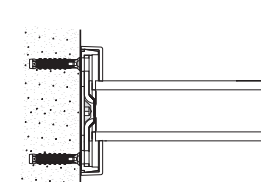

KIT 4CN.0VM.0004.00
In dotazione - Included
- Inclus - Includido:

- N°3 Fischer SX8
- N°3 5x60

Cartongesso e legno stratificato - Plasterboard, Wooden plate - Placoplâtre - Panneau de bois lamellé - Panel de cartón yeso y madera laminada

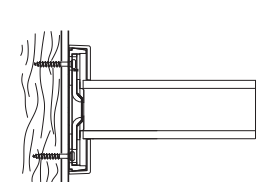

KIT 4CN.0VM.0010.00
In dotazione - Included
- Inclus - Includido:

- N°3 6x80

Ausili
Disabled accessories
Barres de maintien
Asideros

Calcestruzzo e Pietra naturale - Concrete, Natural stone - Béton et Pierre naturelle - Hormigón y piedra natural

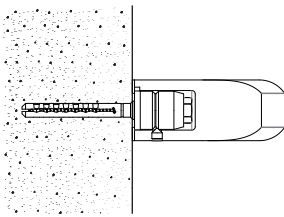

KIT CAP.0VM.MR01.00
In dotazione - Included
- Inclus - Includido:



Mattone pieno e Mattone calcareo - Solid brick, Sand-lime brick - Brique pleine et brique calcaire - Ladrillo macizo y sílico calcáreo

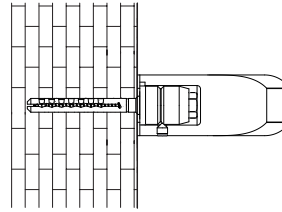

KIT CAP.0VM.MR01.00
In dotazione - Included
- Inclus - Includido:



Cartongesso e legno stratificato - Plasterboard, Wooden plate - Placoplâtre - Panneau de bois lamellé - Panel de cartón yeso y madera laminada

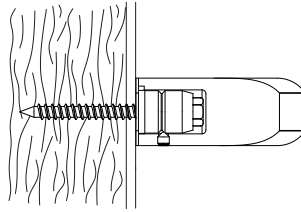

KIT CAP.0VM.CG01.00
In dotazione - Included
- Inclus - Includido:



NOTA: PER FISSAGGI SU ALTRI MATERIALI E PER LO SPESSORE MINIMO DEL LEGNO DA UTILIZZARE COME RINFORZO DEL CARTONGESSO, RIVOLGERSI ALL'UFFICIO TECNICO pba.
NOTE: FOR FIXING ON OTHER MATERIALS AND FOR THE MINIMUM THICKNESS OF THE WOOD REINFORCEMENT FOR PLASTERBOARD, PLEASE CONTACT pba TECHNICAL DEPT.
REMARQUE: POUR FIXATION SUR D'AUTRES MATÉRIAUX ET POUR L'ÉPAISSEUR MINIMUM DU BOIS À UTILISER COMME RENFORCEMENT DANS LE PLACOPLÂTRE, CONTACTEZ LE SERVICE TECHNIQUE pba.
NOTA: PARA FIJAR EN OTROS MATERIALES Y PARA EL ESPESOR MÍNIMO DE LA MADERA QUE HAY QUE UTILIZAR COMO REFUERZO DEL PANEL DE CARTÓN YESO, CONTACTEN EL DEPARTAMENTO TÉCNICO pba.

ART. CAP.440.0000 - CAP.440.000Z

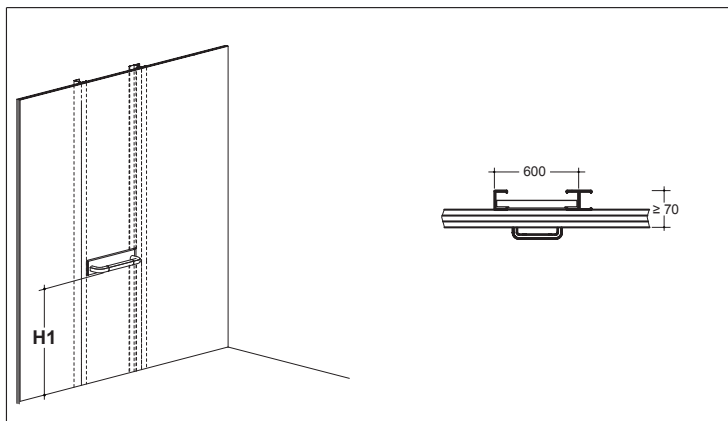
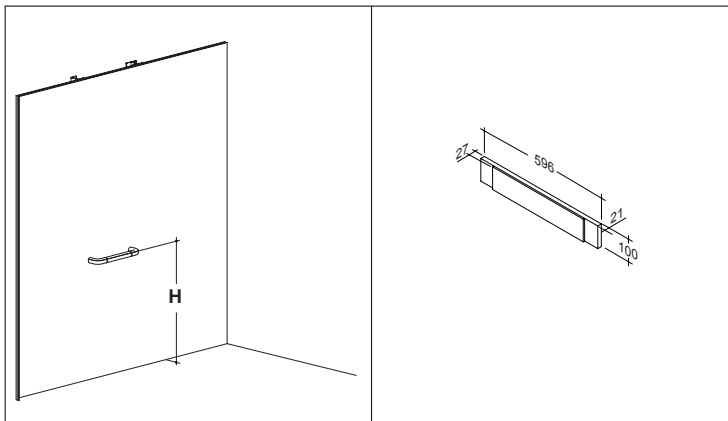

CARTONGESSO - PLASTERBOARD - PLACOPLÂTRE - CARTÓN YESO

(D) DIN 18040-1, DIN 18040-2	H= 850	H1= 780
(I) DM 236 14/06/1989	H= 800	H1= 730
(GB) APPROVED DOCUMENT M	H= 680	H1= 610
(A) Ö - NORM B 1600	H= 750	H1= 680
(F) JORF n°195 (24/08/2006) Text 14 AFNOR NF P 99-611	H= 800	H1= 730

Per le etichette energetiche degli apparecchi di illuminazione: www.pba.it
For the Energy Labels of the illumination instruments see our website: www.pba.it
Pour l'étiquette-énergie des nos appareils d'éclairage voir le site: www.pba.it
Para las etiquetas energéticas de los dispositivos de iluminación: www.pba.it

ART. CAP.445.000T - CAP.445.0000 - CAP.445.000L

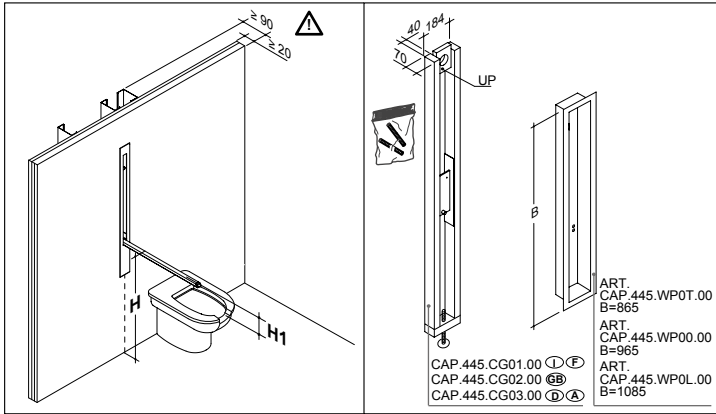

CARTONGESSO - PLASTERBOARD - PLACOPLÂTRE - CARTÓN YESO

(D) DIN 18040-1, DIN 18040-2	H= 740/760	H1= 280	H2= 785/805
(I) DM 236 14/06/1989	H= 800	H1= -	H2= 845
(GB) APPROVED DOCUMENT M	H= 680	H1= -	H2= 725
(A) Ö - NORM B 1600	H= 750	H1= -	H2= 795
(F) JORF n°195 (24/08/2006) Text 14 AFNOR NF P 99-611	H= 800	H1= -	H2= 845

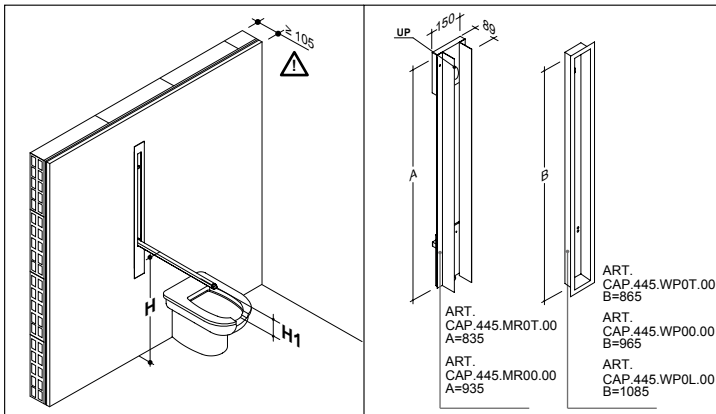
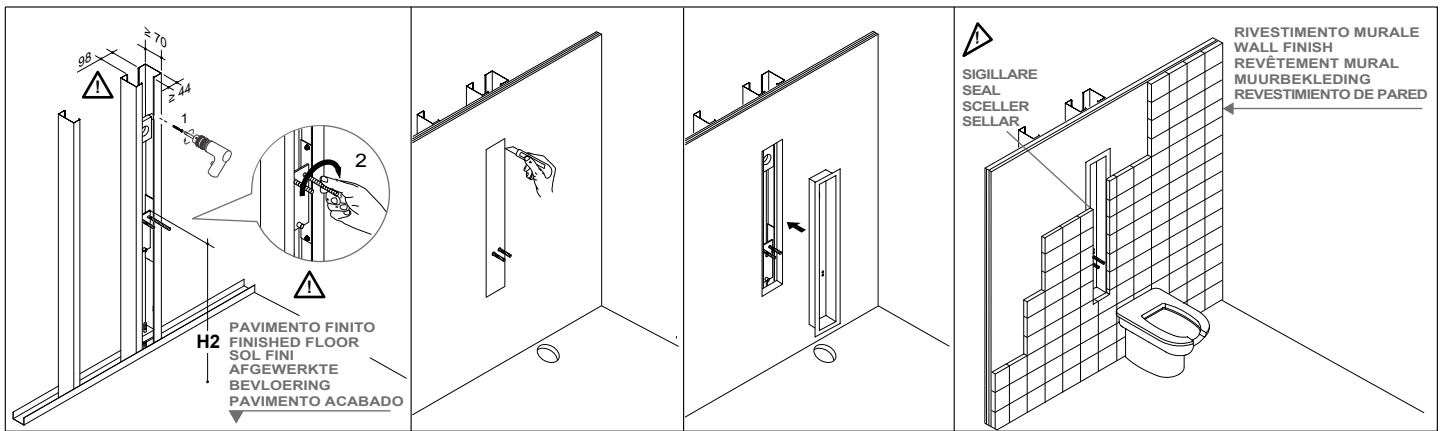

MURATURA - BRICK WALLS - MAÇONNERIE - MAMPOSTERÍA

(D) DIN 18040-1, DIN 18040-2	H= 740/760	H1= 280	H2= 535/555
(I) DM 236 14/06/1989	H= 800	H1= -	H2= 595
(GB) APPROVED DOCUMENT M	H= 680	H1= -	H2= 475
(A) Ö - NORM B 1600	H= 750	H1= -	H2= 545
(F) JORF n°195 (24/08/2006) Text 14 AFNOR NF P 99-611	H= 800	H1= -	H2= 595

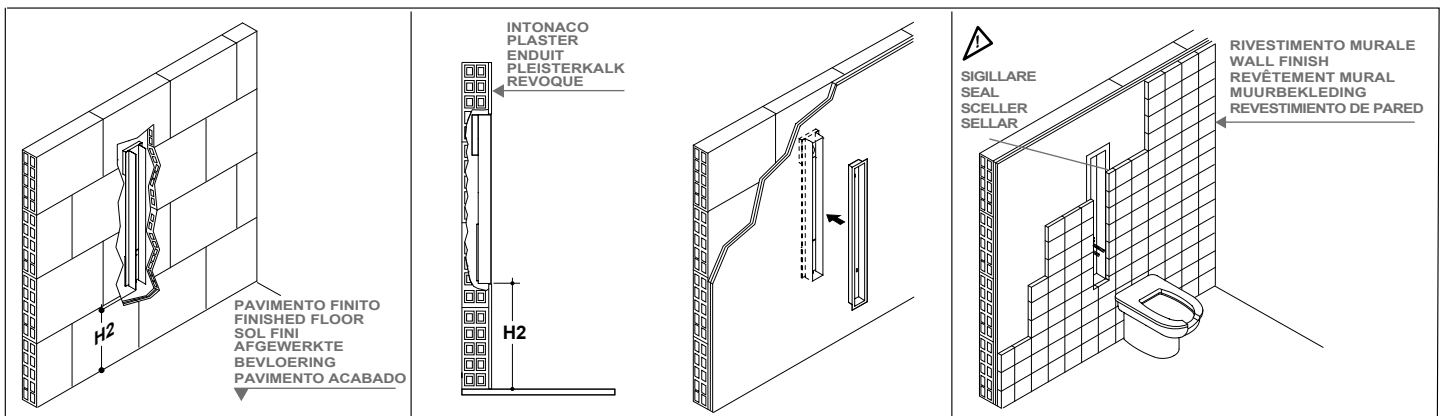

ART. CAP.447.000B

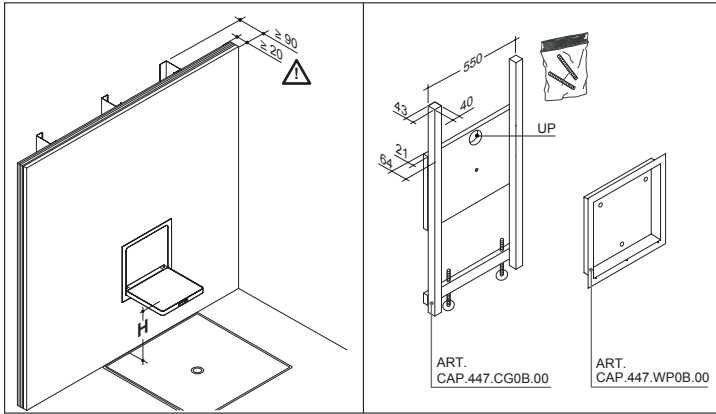

CARTONGESSO - PLASTERBOARD - PLACOPLÂTRE - CARTÓN YESO

(D) DIN 18040-1, DIN 18040-2	H= 480	H1= 840
(I) DM 236 14/06/1989	H= 480	H1= 840
(GB) APPROVED DOCUMENT M	H= 480	H1= 840
(A) Ö - NORM B 1600	H= 480	H1= 840
(F) JORF n°195 (24/08/2006) Text 14 AFNOR NF P 99-611	H= 480	H1= 840

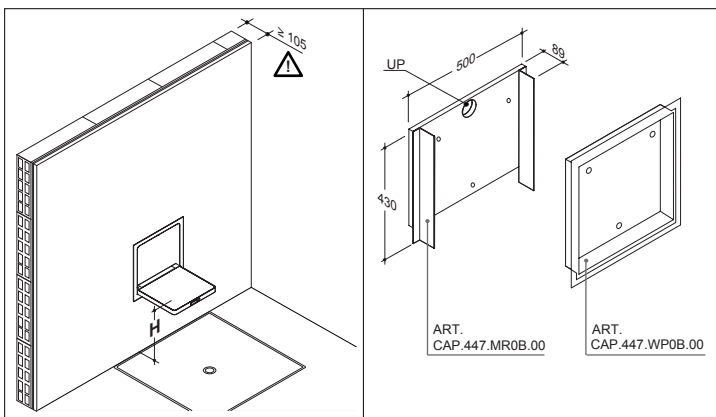
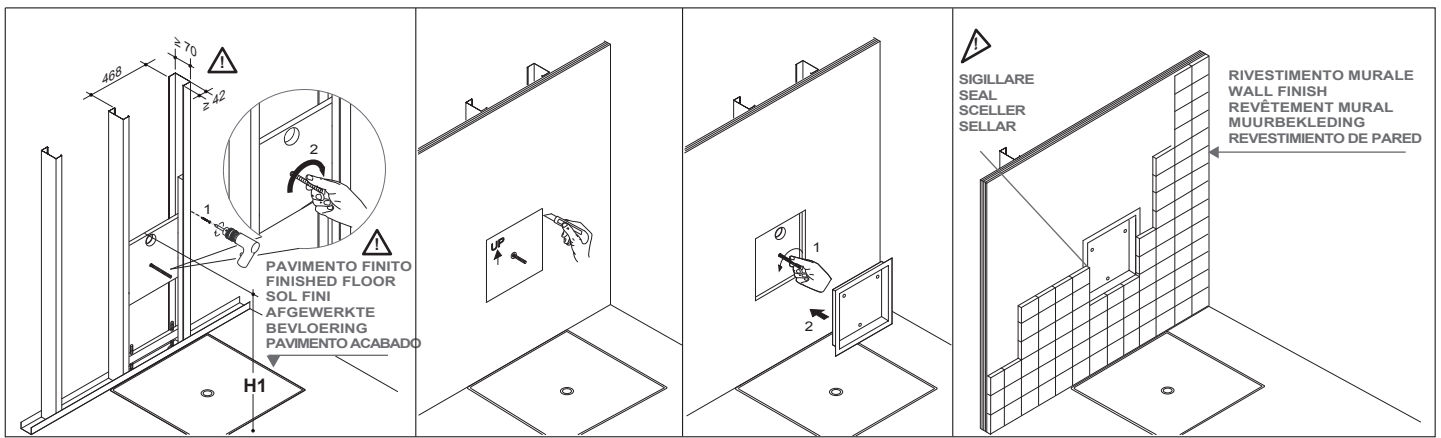

MURATURA - BRICK WALLS - MAÇONNERIE - MAMPOSTERÍA

(D) DIN 18040-1, DIN 18040-2	H= 480	H1= 415
(I) DM 236 14/06/1989	H= 480	H1= 415
(GB) APPROVED DOCUMENT M	H= 480	H1= 415
(A) Ö - NORM B 1600	H= 480	H1= 415
(F) JORF n°195 (24/08/2006) Text 14 AFNOR NF P 99-611	H= 480	H1= 415

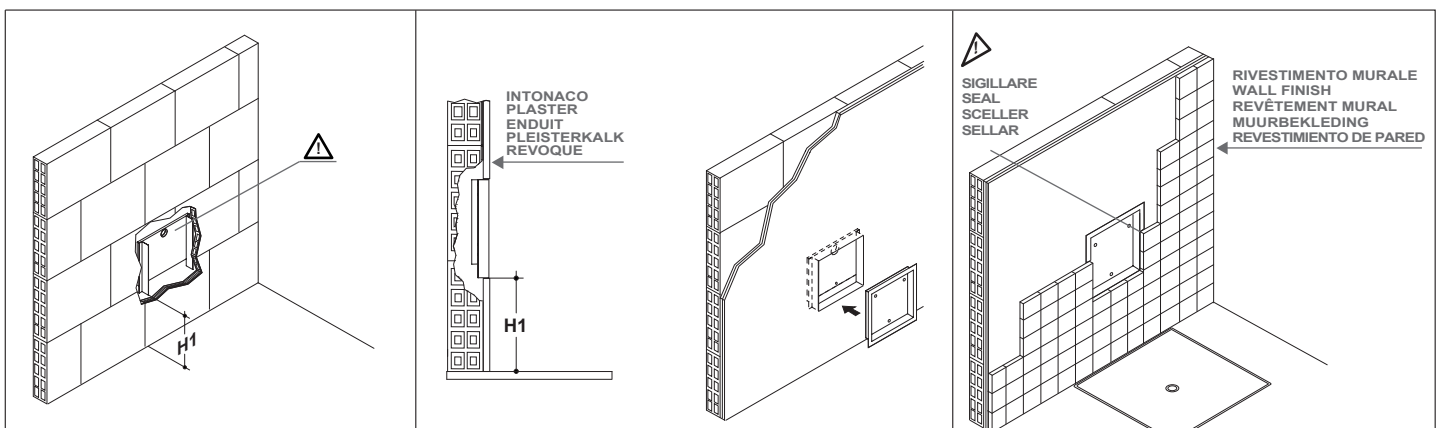

ABRASION RESISTANT TEST



Abrasion Test to BS6161

CONFORMITÀ CE - CE CONFORMITY
CONFORMITÉ CE - CONFORMIDAD CE



Regulation UE 2017/745
Directive 2014/35/UE

MATERIALI - MATERIALS - MATÉRIAUX - MATERIALES

ALUMINUM EN-AW 6060

La lega di alluminio 6060 è una lega a media resistenza con un livello leggermente più basso rispetto alla lega 6005A. Ha un'ottima resistenza alla corrosione, ottima saldabilità e buona resistenza alle basse temperature. È comunemente usata per realizzare elementi anche con forma complessa e risulta molto buona nei processi di anodizzazione.

The aluminum 6060 alloy has an excellent resistance to corrosion, to low temperatures and allows quality weldings. In the design world it is commonly used to create components with complex shapes allowing excellent quality results compared to other alloys for anodizing treatments.

L'alliage d'aluminium 6060 est un alliage pouvant être traité thermiquement de résistance moyenne, avec une résistance légèrement inférieure à l'alliage 6005A. Il présente une très bonne résistance à la corrosion, une très bonne soudabilité et une bonne formabilité à froid. Il est couramment utilisé pour les sections complexes et présente une très bonne réponse au processus d'anodisation.

La aleación de aluminio 6060 es una aleación que se puede tratar con calor de resistencia media, ligeramente inferior a 6005A. Tiene muy buena resistencia a la corrosión, muy buena soldabilidad y buena conformabilidad en frío. Se usa comúnmente para cortes transversales complejos y tiene una respuesta de anodización muy buena.

Alloy	Forms	Characteristics - Properties	Applications
EN - AW 6060	• Extruded round rod/bar	• Very good corrosion resistance • Medium strength • Complex sections • Anodising quality	Architectural sections, frames, lightings, railing, ladders, furniture, fences, flooring

Alloy	Temper	Temper designation (EN 515)
EN - AW 6060	O	Annealed wrought alloys
	T4	Solution heat treated & natural aged
	T5	Cooled from an elevated temperature forming operation & artificially aged (precipitation hardened)
	T6	Solution heat treated & artificially aged (precipitation hardened) Press quenching required
	T64	Solution heat treated & artificially aged (precipitation hardened) Under aged to improve formability (bending temper)
T66	Cooled from an elevated temperature forming operation & artificially aged (precipitation hardened) to a higher level of mechanical properties through special control of manufacturing processes. Press quenching required.	

REGISTRAZIONE MODELLI - REGISTERED MODELS -
MODÈLES ENREGISTRÉS - REGISTRACIÓN MODELOS

I modelli del Programma ART sono stati registrati con domanda di brevetto numero PD2014O000001.

All Programma ART models are registered with application number PD2014O000001.

Tous les modèles Programma ART ont été enregistrés avec la demande de brevet numéro PD2014O000001.

Los modelos del Programma ART se registraron con solicitud de patente número PD2014O000001.

PULIZIA - MAINTENANCE - NETTOYAGE - LIMPIEZA

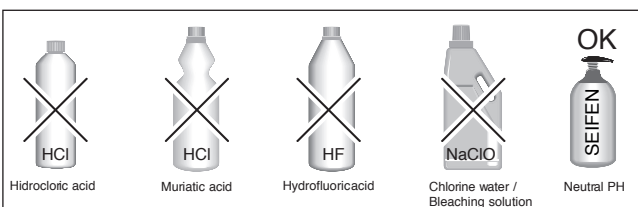

ELEMENTI COSTRUTTIVI - STRUCTURAL ELEMENTS -
ELEMENTS CONSTRUCTIFS - ELEMENTOS CONSTRUCTIVOS



ALUMINUM COMPONENTS
ARE COMPLETELY
SEPARABLE FOR RECYCLE

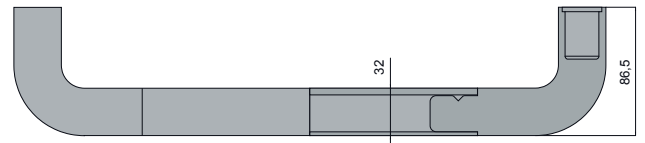

ELEMENTO RETTILINEO

Profilo in alluminio estruso lega EN AW-6060 anodizzato (HB=80MIN)

STRAIGHT ELEMENT

Extruded alloy EN AW-6060 aluminum tube anodized (HB=80MIN)

ÉLÉMENT RECTILIGNE

Tube en aluminium extrudé alliage EN AW-6060 anodisé (HB=80MIN)

ELEMENTO RECTILÍNEO

Perfil de aluminio extruido aleación EN AW-6060 anodizado (HB=80MIN)

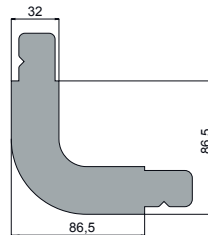

ELEMENTO CURVO A 90°

Curva in alluminio pressofuso con cataforesi e verniciatura

90° BEND

Die-cast aluminum bend with cathaphoresis treatment and powder-coating

ÉLÉMENT CINTRÉ À 90°

Coude en aluminium moulé sous pression avec traitement de cathaphorèse et revêtement en poudre

ELEMENTO CURVO EN ÁNGULO DE 90°

Codo de aluminio moldeado a presión con cataforesi y recubrimiento en polvo

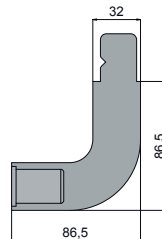

ELEMENTO CURVO TERMINALE A 90°

90° WALL BEND

ÉLÉMENT TERMINAL À ANGLE 90°

ELEMENTO TERMINAL DE PARED EN ÁNGULO A 90°

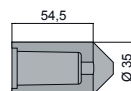

SUPPORTO DRITTO

Supporto in lega di zinco (ZAMAK) con cataforesi e verniciatura

STRAIGHT SUPPORT

Zinc alloy support (ZAMAK) with cathaphoresis treatment and powder-coating

SUPPORT DROIT

Support en alliage de zinc (ZAMAK) avec traitement de cathaphorèse et revêtement en poudre

SOPORTE RECTO

Soporte de aleación de zinc (ZAMAK) con cataforesi y recubrimiento en polvo

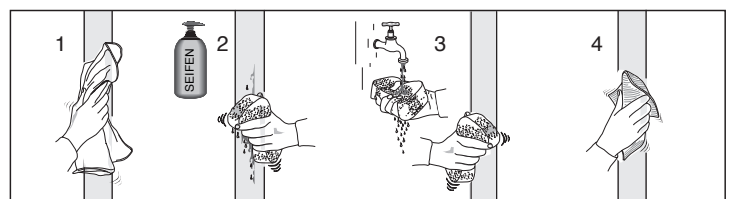

GUIDA AL PROGETTO - GUIDE TO THE PROJECT - DESCRIPTIF PROJET - GUÍA PARA EL PROYECTO

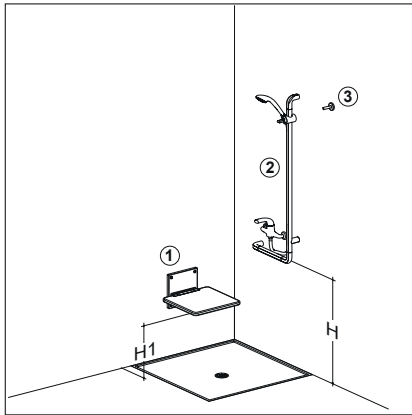

① ART.447.00CM	② ART.22J.00LA	③ ART.562.0000		
(D) DIN 18040-1 DIN 1804-2			H= 850	H1= 460/480
(I) DM 236 14/06/1989			H= 800	H1= 450/500
(GB) APPROVED DOCUMENT M			H= 680	H1= 480
(A) Ö - NORM B 1600			H= 750/850	H1= 460/480
(F) JORF n°195 (24/08/2006) Text 14 AFNOR NF P 99-611			H= 700/800	H1= 450/500
(CH) SIA 500			H= 700/750	H1= 460

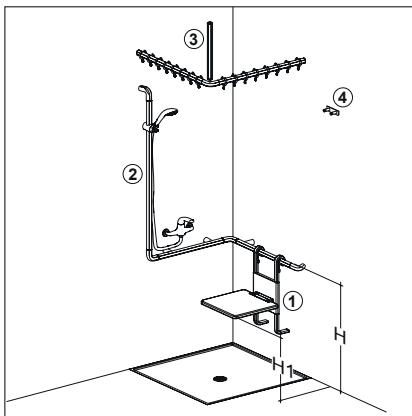

① ART.450.00CM ART.450.0CML	② ART.24J.00LA	③ ART.436.000B	④ ART.488.0000	
(D) DIN 18040-1 (ART.450.0CML) DIN 18040-2 (ART.450.0CML)				H= 850 H1= 480
(I) DM 236 14/06/1989 (ART.450.00CM)				H= 800 H1= 500
(GB) APPROVED DOCUMENT M				H= 680 H1= -
(A) Ö - NORM B 1600 (ART.450.00CM) (ART.450.0CML)				H= 760/780 H= 830/850 H1= 460/480 H1= 460/480
(F) JORF n°195 (24/08/2006) Text 14 AFNOR NF P 99-611 (ART.450.00CM)				H= 770/800 H1= 450/500
(CH) SIA 500				H= 700/750 H1= 460

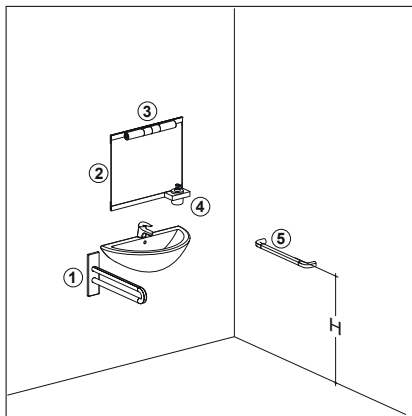

① ART.441.000P	② ART.470.0000	③ 4CN.407.0TUA	④ ART.485.00AL	⑤ ART.440.000A
(D) DIN 18040-1 DIN 18040-2				
(I) DM 236 14/06/1989				
(GB) APPROVED DOCUMENT M				
(A) Ö - NORM B 1600				
(F) JORF n°195 (24/08/2006) Text 14 AFNOR NF P 99-611				
(CH) SIA 500				

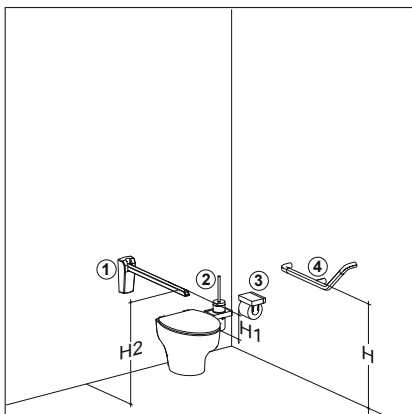

① ART.445.0000	② ART.486.000C	③ ART.481.0000	④ ART.427.0000	
(D) DIN 18040-1 DIN 18040-2				H= 850 H1= 280 H2= 740/760
(I) DM 236 14/06/1989				H= 800 H1= - H2= 800
(GB) APPROVED DOCUMENT M				H= 680 H1= - H2= 680
(A) Ö - NORM B 1600				H= 750 H1= - H2= 750
(F) JORF n°195 (24/08/2006) Text 14 AFNOR NF P 99-611				H= 700/800 H1= - H2= 700/800
(CH) SIA 500				H= 700/750 H1= 290 H2= 700/750

I riferimenti normativi sono riferiti alle quote di installazione da pavimento, non alle altre distanze e alle tipologie di bagno.
 The norms references refer to installation measurements from the floor and not to other distances and types of bathroom.
 Les références normatives se réfèrent aux mesures d'installation du sol et pas à d'autres distances et types de salle de bain.
 Las referencias normativas se refieren a las medidas de montaje desde suelo y no a otras distancias y tipos de baño.

SISTEMI DI FISSAGGIO - FIXING MATERIAL - SISTÈMES DE FIXATION - SISTEMAS DE FIJACIÓN

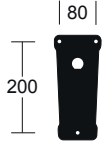

Art. ART.441.000P. xx
Art. ART.441.00PL. xx
Art. ART.441.0PLL. xx

Calcestruzzo e Pietra naturale - Concrete, Natural stone - Béton et Pierre naturelle - Hormigón y piedra natural

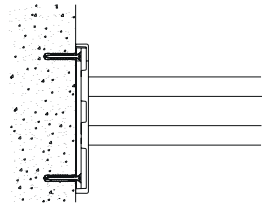

KIT 4CN.0VM.0014.00
In dotazione - Included
- Inclus - Includido:
N°3 Fischer FU 10x60
N°3 6,3x80 INOX
N°3 bussola guida
guide bushes
douilles de guidage
casquillo guía

Mattone pieno e Mattone calcareo - Solid brick, Sand-lime brick - Brique pleine et brique calcaire - Ladrillo macizo y silico calcáreo

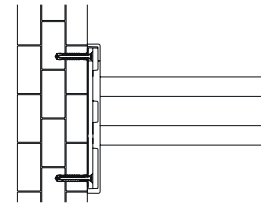

KIT 4CN.0VM.0014.00
In dotazione - Included
- Inclus - Includido:
N°3 Fischer FU 10x60
N°3 6,3x80 INOX
N°3 bussola guida
guide bushes
douilles de guidage
casquillo guía

Mattone forato - Hollow brick masonry - Brique creuse - Ladrillo hueco

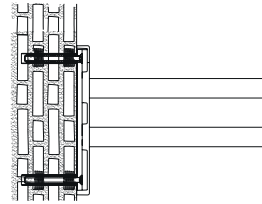

KIT 4CN.0VM.0033.00
A pagamento - Extra
- En supplément - De pago:
N°3 Fischer FIS H 16X85 K
N°3 M8X30 INOX
N°3 FIS E 11X85 M8

Cartongesso e legno stratificato - Plasterboard, Wooden plate - Placoplâtre - Panneau de bois lamellé - Panel de cartón yeso y madera laminada

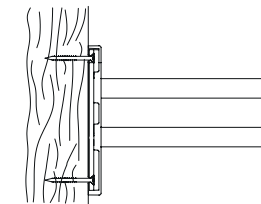

KIT 4CN.0VM.0017.00
A pagamento - Extra
- En supplément - De pago:
N°3 8x90 INOX

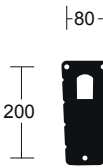

Art. ART.445.000T.xx
ART.45Y.000T.xx
ART.45K.000T.xx
ART.445.0000.xx
ART.45Y.0000.xx
ART.45K.0000.xx
ART.445.000L.xx
ART.45Y.000L.xx
ART.45K.000L.xx

Calcestruzzo e Pietra naturale - Concrete, Natural stone - Béton et Pierre naturelle - Hormigón y piedra natural

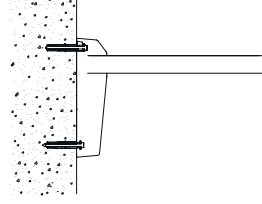

KIT 4CN.0VM.0014.00
In dotazione - Included
- Inclus - Includido:
N°3 Fischer FU 10x60
N°3 6,3x80 INOX
N°3 bussola guida
guide bushes
douilles de guidage
casquillo guía

Mattone pieno e Mattone calcareo - Solid brick, Sand-lime brick - Brique pleine et brique calcaire - Ladrillo macizo y silico calcáreo

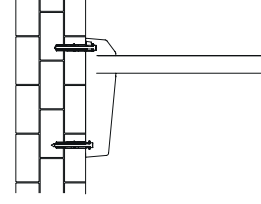

KIT 4CN.0VM.0014.00
In dotazione - Included
- Inclus - Includido:
N°3 Fischer FU 10x60
N°3 6,3x80 INOX
N°3 bussola guida
guide bushes
douilles de guidage
casquillo guía

Mattone forato - Hollow brick masonry - Brique creuse - Ladrillo hueco

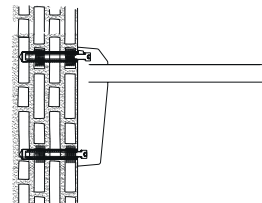

KIT 4CN.0VM.0033.00
A pagamento - Extra
- En supplément - De pago:
N°3 Fischer FIS H 16X85 K
N°3 M8X30 INOX
N°3 FIS E 11X85 M8

Cartongesso e legno stratificato - Plasterboard, Wooden plate - Placoplâtre - Panneau de bois lamellé - Panel de cartón yeso y madera laminada

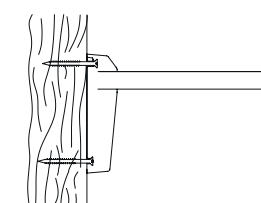

KIT 4CN.0VM.0034.00
A pagamento - Extra
- En supplément - De pago:
N°3 8x90 INOX

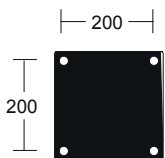

Art. 4CN.447.00CM.xx
4CN.47K.00CM.xx

Calcestruzzo e Pietra naturale - Concrete, Natural stone - Béton et Pierre naturelle - Hormigón y piedra natural

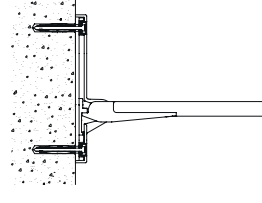

KIT 4CN.0VM.0001.00
In dotazione - Included
- Inclus - Includido:
N°4 Fischer FU 10x60
N°4 6,3x80 INOX
N°4 bussola guida
guide bushes
douilles de guidage
casquillo guía

Mattone pieno e Mattone calcareo - Solid brick, Sand-lime brick - Brique pleine et brique calcaire - Ladrillo macizo y silico calcáreo

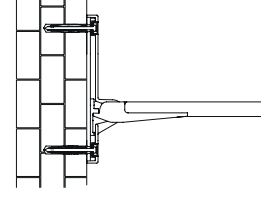

KIT 4CN.0VM.0001.00
In dotazione - Included
- Inclus - Includido:
N°4 Fischer FU 10x60
N°4 6,3x80 INOX
N°4 bussola guida
guide bushes
douilles de guidage
casquillo guía

Mattone forato - Hollow brick masonry - Brique creuse - Ladrillo hueco

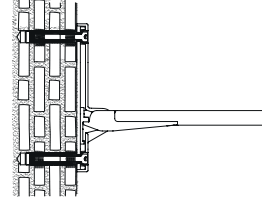

KIT 4CN.0VM.0003.00
A pagamento - Extra
- En supplément - De pago:
N°4 Fischer FIS H 20X85 K
N°4 M10X30 INOX
N°4 FIS E 15X85 M10

Cartongesso e legno stratificato - Plasterboard, Wooden plate - Placoplâtre - Panneau de bois lamellé - Panel de cartón yeso y madera laminada

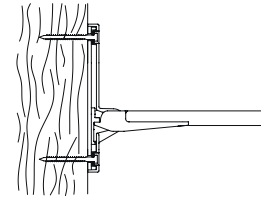

KIT 4CN.0VM.0009.00
A pagamento - Extra
- En supplément - De pago:
N°4 8x90 INOX
N°4 bussola guida
guide bushes
douilles de guidage
casquillo guía

50



Ausili con rosetta e Art.
Disabled accessories with washer and Art.
Barres de maintien avec rosace et Art.
Asideros con roseta y Art.

- ART.429.0000.75
- ART.429.000A.75
- ART.429.000B.75
- ART.429.000C.75
- ART.429.000D.75
- ART.429.000E.75
- ART.429.9999.75

Calcestruzzo e Pietra naturale - Concrete, Natural stone - Béton et Pierre naturelle - Hormigón y piedra natural

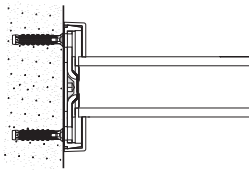

KIT 4CN.0VM.0004.00
In dotazione - Included
- Inclus - Includido:
N°3 Fischer SX8
N°3 5x60

Cartongesso e legno stratificato - Plasterboard, Wooden plate - Placoplâtre - Panneau de bois lamellé - Panel de cartón yeso y madera laminada

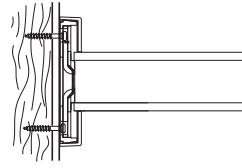

KIT 4CN.0VM.0010.00
In dotazione - Included
- Inclus - Includido:
N°3 6x80

Sostegni di sicurezza
Safety supports
Barres d'appui
Asideros

Calcestruzzo e Pietra naturale - Concrete, Natural stone - Béton et Pierre naturelle - Hormigón y piedra natural

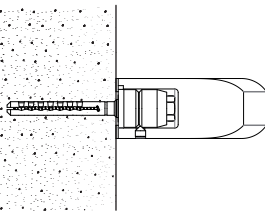

KIT CAP.0VM.MR01.00
In dotazione - Included
- Inclus - Includido:



Mattone pieno e Mattone calcareo - Solid brick, Sand-lime brick - Brique pleine et brique calcaire - Ladrillo macizo y sílico calcáreo

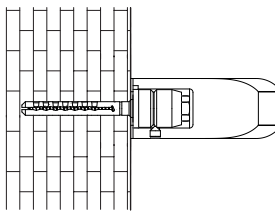

KIT CAP.0VM.MR01.00
In dotazione - Included
- Inclus - Includido:



Cartongesso e legno stratificato - Plasterboard, Wooden plate - Placoplâtre - Panneau de bois lamellé - Panel de cartón yeso y madera laminada

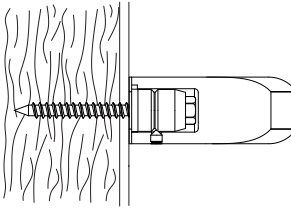

KIT CAP.0VM.CG01.00
In dotazione - Included
- Inclus - Includido:



NOTA: PER FISSAGGI SU ALTRI MATERIALI E PER LO SPESSORE MINIMO DEL LEGNO DA UTILIZZARE COME RINFORZO DEL CARTONGESSO, RIVOLGERSI ALL'UFFICIO TECNICO pba.
NOTE: FOR FIXING ON OTHER MATERIALS AND FOR THE MINIMUM THICKNESS OF THE WOOD REINFORCEMENT FOR PLASTERBOARD, PLEASE CONTACT pba TECHNICAL DEPT.
REMARQUE: POUR FIXATION SUR D'AUTRES MATÉRIAUX ET POUR L'ÉPAISSEUR MINIMUM DU BOIS À UTILISER COMME RENFORCEMENT DANS LE PLACOPLÂTRE, CONTACTEZ LE SERVICE TECHNIQUE pba.
NOTA: PARA FIJAR EN OTROS MATERIALES Y PARA EL ESPESOR MÍNIMO DE LA MADERA QUE HAY QUE UTILIZAR COMO REFUERZO DEL PANEL DE CARTÓN YESO, CONTACTEN EL DEPARTAMENTO TÉCNICO pba.

ART. ART.440.0000 - ART.440.000Z

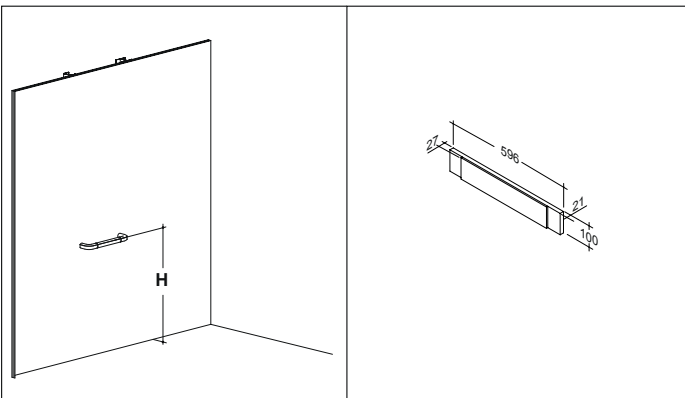

CARTONGESSO - PLASTERBOARD - PLACOPLÂTRE - CARTÓN YESO

- (D)** DIN 18040-1, DIN 18040-2 H= 850 H
- (I)** DM 236 14/06/1989 H= 800 H1= 730
- (GB)** APPROVED DOCUMENT M H= 680 H1= 610
- (A)** Ö - NORM B 1600 H= 750 H1= 680
- (F)** JORF n°195 (24/08/2006) H= 800 H
Text 14 AFNOR NF P 99-611

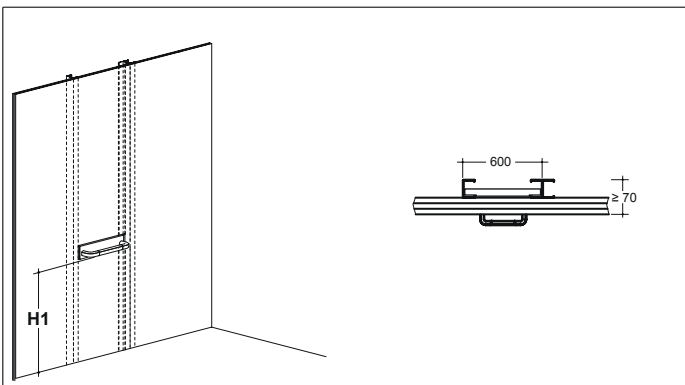

Per le etichette energetiche degli apparecchi di illuminazione: www.pba.it
For the Energy Labels of the illumination instruments see our website: www.pba.it
Pour l'étiquette-énergie des nos appareils d'éclairage voir le site: www.pba.it
Para las etiquetas energéticas de los dispositivos de iluminación: www.pba.it

CERTIFICATO TÜV - TÜV CERTIFICATE
CERTIFICAT TÜV - CERTIFICACIÓN TÜV



Certificate N° : Z1 029615 0022

CONFORMITÀ CE - CE CONFORMITY
CONFORMITÉ CE
CONFORMIDAD CE



Regulation UE 2017/745
Directive 2014/35/UE

TEST CITOTOSSICITÀ - CITOTOXICITY TEST
TEST DE CYTOTOXICITÉ
PRUEBA DE CITOTOXICIDAD

Cytotoxicity test to DIN EN ISO 10993-5

MATERIALI - MATERIALS - MATÉRIAUX - MATERIALES AISI 316L

Chemical compositions of AISI stainless steel grades

Material - Stainless	C%	Cr%	Ni%	Mo%
AISI 430 (1.4016)	0,12 max	14.0-18.0	/	/
AISI 304 (1.4301)	0,08 max	18.0-20.0	8.0-10.5	/
AISI 316 (1.4401)	0,08 max	16.0-18.0	10.0-14.0	2.00-3.00
pba AISI 316L (1.4404)*	0,03 max	16.0-18.0	10.0-14.0	2.00-3.00

*Standard pba

Estimated pit corrosion penetration time - time to penetrate 1 mm (years) by steel type

Material - Stainless	Marine	Semi_industrial	Rural
AISI 430 (1.4016)	N/A	85	250
AISI 304 (1.4301)	145	135	770
AISI 316 (1.4401)	260	525	1200

Source: The British Stainless Steel Association (BSSA)

CERTIFICAZIONE MATERIALE - MATERIAL CERTIFICATION -
CERTIFICATION DU MATÉRIEL - CERTIFICACIÓN DEL MATERIAL AISI 316L

L'acciaio usato da pba, acciaio inox AISI 316L (1), garantisce il massimo grado di resistenza alla corrosione: normativa di riferimento UNI EN 1670; certificazione ottenuta dopo test di corrosione in nebbia salina secondo UNI ISO 9227.

(1) X2CrNiMo 17-12-2 secondo designazione EN 10088-3

The AISI 316L stainless steel (1) steel used by pba, meets the requirements of UNI EN 1670, the ultimate quality standard for ensuring resistance to corrosion. pba has been awarded a certificate for successfully salt spray testing the stainless steel in accordance with UNI ISO 9227.

(1) X2CrNiMo 17-12-2 as per EN 10088-3

L'acier utilisé par pba, acier inoxydable AISI 316L (1), garantit le degré maximum de résistance à la corrosion : norme de référence UNI EN 1670; certification obtenue après un essai de corrosion par exposition à un brouillard salin conformément à UNI ISO 9227.

(1) X2CrNiMo 17-12-2 conforme à la désignation EN 10088-3

El acero utilizado por pba, acero inoxidable AISI 316L (1), garantiza el grado máximo de resistencia a la corrosión: norma UNI EN 1670; certificación obtenida después de un ensayo de resistencia contra la corrosión en nebla salina según los estándares UNI ISO 9227.

(1) X2CrNiMo 17-12-2 según EN 10088-3

PULIZIA - MAINTENANCE - NETTOYAGE - LIMPIEZA

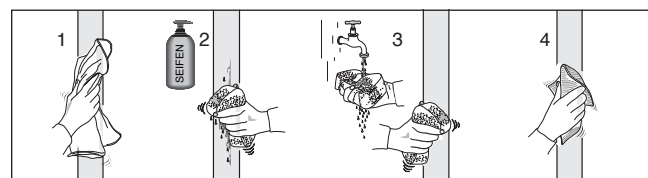
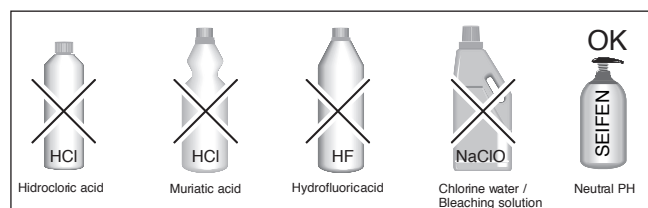

ELEMENTI COSTRUTTIVI - STRUCTURAL ELEMENTS - ELEMENTS
CONSTRUCTIFS - COMPONENTEN - ELEMENTOS CONSTRUCTIVOS

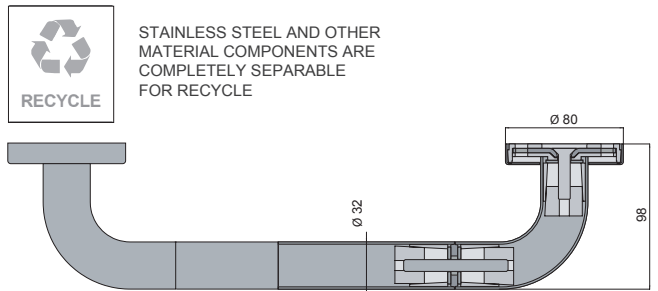

ELEMENTO RETTILINEO AISI 316L

Tubo in acciaio inox AISI 316L con Ø 32 mm e spessore 15/10.

STRAIGHT ELEMENT AISI 316L

Rail in AISI 316L stainless steel, Ø 32 mm, 15/10 thickness.

ÉLÉMENT RECTILIGNE AISI 316L

Tube en acier inoxydable AISI 316L, de Ø 32 mm et 15/10 d'épaisseur.

ELEMENTO RECTILÍNEO AISI 316L

Tubo de acero inoxidable AISI 316L con Ø 32 mm y grueso 15/10.

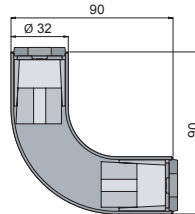
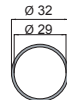

ELEMENTO CURVO A 90° AISI 316L

Curva in acciaio inox AISI 316L con Ø 32 mm e spessore 15/10 con all'interno tasselli filettati.

90° BEND AISI 316L

Bend in AISI 316L stainless steel, Ø 32 mm, 15/10 thickness, with threaded inserts inside.

ÉLÉMENT CINTRÉ À 90° AISI 316L

Coude en acier inoxydable AISI 316L, de Ø 32 mm et 15/10 d'épaisseur avec inserts filetés à l'intérieur.

ELEMENTO CURVO EN ÁNGULO DE 90° AISI 316L

Codo de acero inoxidable AISI 316L con Ø 32 mm y grueso 15/10 con encastrados roscados al interior.

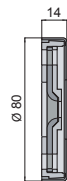

ROSETTA AISI 316L

Flangia in acciaio trattato con fori per il fissaggio a muro rivestita di nylon. Coperchio copriviti in acciaio inox AISI 316L.

ROSE AISI 316L

Flange in steel with holes for wall mounting, with nylon covering.

ROSACE AISI 316L

Rosace en acier traité avec trous pour la fixation murale revêtue de nylon Rosace de finition en acier inoxydable AISI 316L.

ROSETA AISI 316L

Roseta de acero tratado con perforaciones para fijación contra paredes, forrado de nylon. Cubre-tornillos de acero inoxidable AISI 316L.

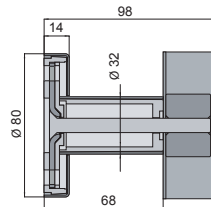

SUPPORTO DRITTO AISI 316L

Supporto in acciaio inox AISI 316L.

STRAIGHT SUPPORT AISI 316L

Support in AISI 316L stainless steel.

SUPPORT DROIT AISI 316L

Support en acier inoxydable AISI 316L.

SOPORTE RECTO AISI 316L

Soporte de acero inoxidable AISI 316L.

ANTISUICIDE SERIE



STAINLESS STEEL AND OTHER MATERIAL COMPONENTS ARE COMPLETELY SEPARABLE FOR RECYCLE

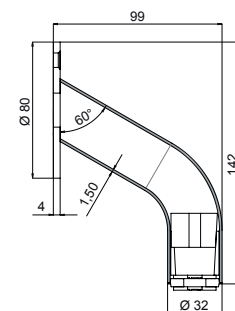

ELEMENTO INCLINATO A 45°

45° INCLINED BEND

ÉLÉMENT INCLINÉ À ANGLE 45°

ELEMENTO INCLINADO EN ÁNGULO DE 45°

GUIDA AL PROGETTO - GUIDE TO THE PROJECT - DESCRIPTIF PROJET - GUÍA PARA EL PROYECTO

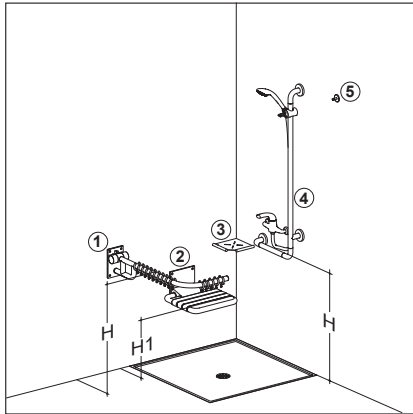

① 4CS.435.0000	② 4CS.447.000B	③ 4CS.493.0000	④ 4CS.22J.0000	⑤ 4CS.488.0000
(D) DIN 18040-1 DIN 18040-2			H= 850	H1= 460/480
(I) DM 236 14/06/1989			H= 800	H1= 450/500
(GB) APPROVED DOCUMENT M			H= 680	H1= 480
(A) Ö - NORM B 1600			H= 750/850	H1= 460/480
(F) JORF n°195 (24/08/2006) Text 14 AFNOR NF P 99-611			H= 700/800	H1= 450/500
(CH) SIA 500			H= 700/750	H1= 460

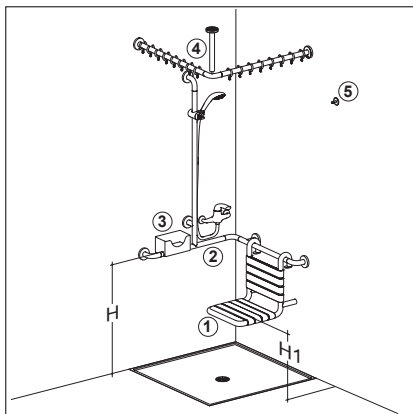

① 4CS.446.000B 4CS.446.000BL	② 4CS.43J.000B	③ 4CS.492.000B.17	④ 4CS.436.000B	⑤ 4CS.488.0000
(D) DIN 18040-1 (4CS.446.00BL) DIN 18040-2 (4CS.446.00BL)			H= 850	H1= 480
(I) DM 236 14/06/1989 (4CS.446.000B)			H= 800	H1= 480
(GB) APPROVED DOCUMENT M			H= 680	H1= -
(A) Ö - NORM B 1600 (4CS.446.000B) (4CS.446.00BL)			H= 780/800 H= 830/850	H1= 460/480 H1= 460/480
(F) JORF n°195 (24/08/2006) Text 14 AFNOR NF P 99-611 (4CS.446.000B)			H= 770/800	H1= 450/480
(CH) SIA 500			H= 700/750	H1= 460

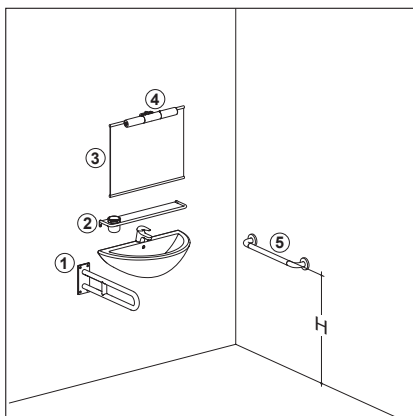

① 4CS.441.000P	② 4CS.485.000N	③ 4CS.470.0000	④ 4CS.407.00TU.17	⑤ 4CS.440.0000
(D) DIN 18040-1 DIN 18040-2			H= 850	
(I) DM 236 14/06/1989			H= 800	
(GB) APPROVED DOCUMENT M			H= 680	
(A) Ö - NORM B 1600			H= 750	
(F) JORF n°195 (24/08/2006) Text 14 AFNOR NF P 99-611			H= 700/800	
(CH) SIA 500			H= 700/750	

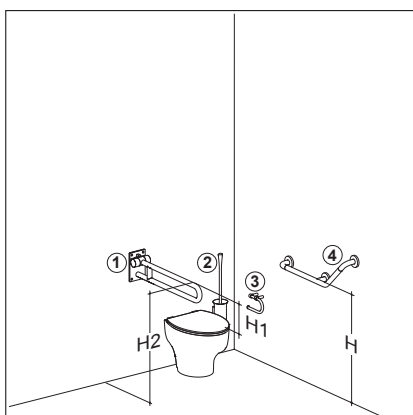

① 4CS.445.0000	② 4CS.486.0000	③ 4CS.481.0000	④ 4CS.427.0000	
(D) DIN 18040-1 DIN 18040-2			H= 850	H1= 280 H2= 740/760
(I) DM 236 14/06/1989			H= 800	H1= - H2= 800
(GB) APPROVED DOCUMENT M			H= 680	H1= - H2= 680
(A) Ö - NORM B 1600			H= 750	H1= - H2= 750
(F) JORF n°195 (24/08/2006) Text 14 AFNOR NF P 99-611			H= 700/800	H1= - H2= 700/800
(CH) SIA 500			H= 700/750	H1= 290 H2= 700/750

I riferimenti normativi sono riferiti alle quote di installazione da pavimento, non alle altre distanze e alle tipologie di bagno.
 The norms references refer to installation measurements from the floor and not to other distances and types of bathroom.
 Les références normatives se réfèrent aux mesures d'installation du sol et pas à d'autres distances et types de salle de bain.
 Las referencias normativas se refieren a las medidas de montaje desde suelo y no a otras distancias y tipos de baño.

SISTEMI DI FISSAGGIO - FIXING MATERIAL - SISTÈMES DE FIXATION - SISTEMAS DE FIJACIÓN

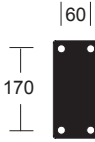

Art. 4CS.441.000P.xx
4CS.441.00PL.xx
4CS.441.00PLL.xx
4CS.441.00PA.xx
4CS.441.0PLA.xx
4CS.441.PLLA.xx

Calcestruzzo e Pietra naturale - Concrete, Natural stone - Béton et Pierre naturelle - Hormigón y piedra natural

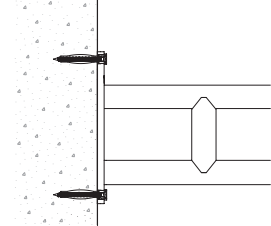

KIT 4CN.0VM.001A.00
In dotazione - Included
- Inclus - Includido:

- N°4 Fischer FU 10x60
- N°4 6x80
- N°4 bussola guida
guide bushes
douilles de guidage
casquillo guía

Mattone pieno e Mattone calcareo - Solid brick, Sand-lime brick - Brique pleine et brique calcaire - Ladrillo macizo y sílico calcáreo

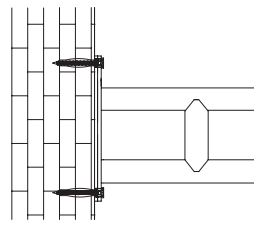

KIT 4CN.0VM.001A.00
In dotazione - Included
- Inclus - Includido:

- N°4 Fischer FU 10x60
- N°4 6x80
- N°4 bussola guida
guide bushes
douilles de guidage
casquillo guía

Mattone forato - Hollow brick masonry - Brique creuse - Ladrillo hueco

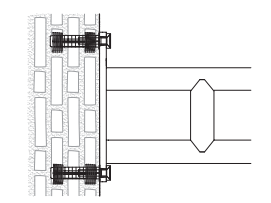

KIT 4CN.0VM.003A.00
A pagamento - Extra -
En supplément De pago :

- N°4 Fischer FIS H 20X85 K
- N°4 M10X35 INOX
- N°4 FIS E 15X85 M10
- N°4 bussola guida
guide bushes
douilles de guidage
casquillo guía

Cartongesso e legno stratificato - Plasterboard, Wooden plate - Placoplâtre - Panneau de bois lamellé - Panel de cartón yeso y madera laminada

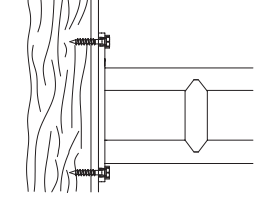

KIT 4CN.0VM.009A.00
A pagamento - Extra -
En supplément De pago :

- N°4 8x90
- N°4 bussola guida
guide bushes
douilles de guidage
casquillo guía

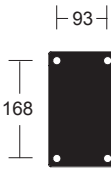

Art. 4CS.435.0000.xx.1
4CS.435.0000.xx.2
4CS.445.0000.xx
4CS.445.000A.xx

Calcestruzzo e Pietra naturale - Concrete, Natural stone - Béton et Pierre naturelle - Hormigón y piedra natural

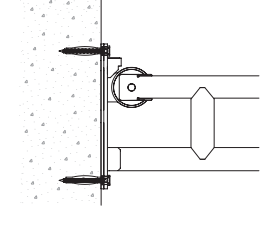

KIT 4CN.0VM.001A.00
In dotazione - Included
- Inclus - Includido:

- N°4 Fischer FU 10x60
- N°4 6x80
- N°4 bussola guida
guide bushes
douilles de guidage
casquillo guía

Mattone pieno e Mattone calcareo - Solid brick, Sand-lime brick - Brique pleine et brique calcaire - Ladrillo macizo y sílico calcáreo

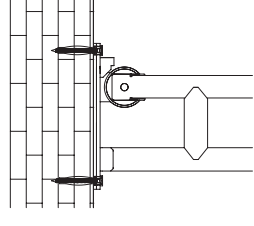

KIT 4CN.0VM.001A.00
In dotazione - Included
- Inclus - Includido:

- N°4 Fischer FU 10x60
- N°4 6x80
- N°4 bussola guida
guide bushes
douilles de guidage
casquillo guía

Mattone forato - Hollow brick masonry - Brique creuse - Ladrillo hueco

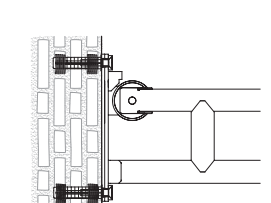

KIT 4CN.0VM.003A.00
A pagamento - Extra -
En supplément - De pago :

- N°4 Fischer FIS H 20X85 K
- N°4 M10X35 INOX
- N°4 FIS E 15X85 M10
- N°4 bussola guida
guide bushes
douilles de guidage
casquillo guía

Cartongesso e legno stratificato - Plasterboard, Wooden plate - Placoplâtre - Panneau de bois lamellé - Panel de cartón yeso y madera laminada

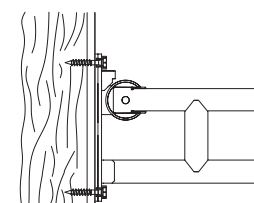

KIT 4CN.0VM.009A.00
A pagamento - Extra -
En supplément - De pago :

- N°4 8x90
- N°4 bussola guida
guide bushes
douilles de guidage
casquillo guía

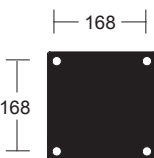

Art. 4CS.447.000B.xx
4CS.47K.000B.xx

Calcestruzzo e Pietra naturale - Concrete, Natural stone - Béton et Pierre naturelle - Hormigón y piedra natural

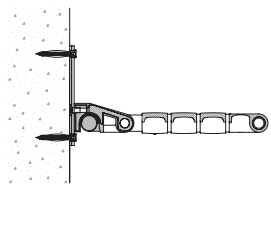

KIT 4CN.0VM.001A.00
In dotazione - Included
- Inclus - Includido:

- N°4 Fischer FU 10x60
- N°4 6x80
- N°4 bussola guida
guide bushes
douilles de guidage
casquillo guía

Mattone pieno e Mattone calcareo - Solid brick, Sand-lime brick - Brique pleine et brique calcaire - Ladrillo macizo y sílico calcáreo

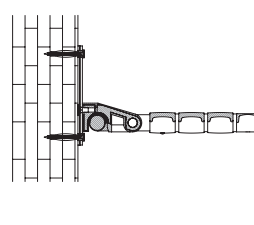

KIT 4CN.0VM.001A.00
In dotazione - Included
- Inclus - Includido:

- N°4 Fischer FU 10x60
- N°4 6x80
- N°4 bussola guida
guide bushes
douilles de guidage
casquillo guía

Mattone forato - Hollow brick masonry - Brique creuse - Ladrillo hueco

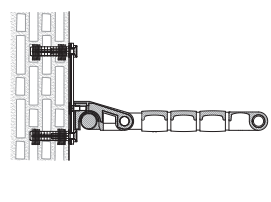

KIT 4CN.0VM.003A.00
A pagamento - Extra -
En supplément - De pago :

- N°4 Fischer FIS H 20X85 K
- N°4 M10X35 INOX
- N°4 FIS E 15X85 M10
- N°4 bussola guida
guide bushes
douilles de guidage
casquillo guía

Cartongesso e legno stratificato - Plasterboard, Wooden plate - Placoplâtre - Panneau de bois lamellé - Panel de cartón yeso y madera laminada

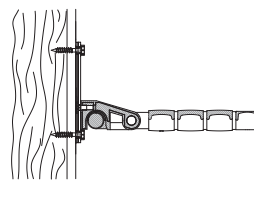

KIT 4CN.0VM.009A.00
A pagamento - Extra -
En supplément - De pago :

- N°4 8x90
- N°4 bussola guida
guide bushes
douilles de guidage
casquillo guía

| 50 |



Ausili con rosetta
Disabled Accessories
with washer
Barres de maintien
avec rosace
Asideros con roseta

Calcestruzzo e Pietra naturale - Concrete, Natural stone - Béton et Pierre naturelle - Hormigón y piedra natural

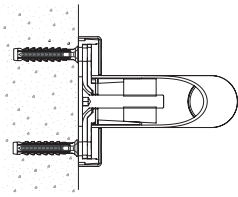

KIT 4CN.0VM.0004.00
In dotazione - Included
- Inclus - Includido:

— N°3 Fischer SX8
— N°3 5x60

Mattone pieno e Mattone calcareo - Solid brick, Sand-lime brick - Brique pleine et brique calcaire - Ladrillo macizo y sílico calcáreo

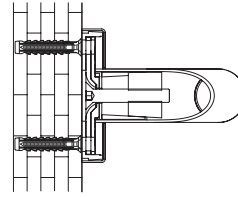

KIT 4CN.0VM.0004.00
In dotazione - Included
- Inclus - Includido:

— N°3 Fischer SX8
— N°3 5x60

Mattone forato - Hollow brick masonry - Brique creuse - Ladrillo hueco

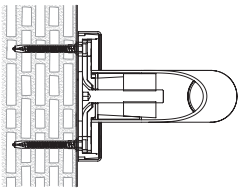

KIT 4CN.0VM.0005.00
A pagamento - Extra -
En supplément - De pago:

— N°3 Fischer FUR 8x80T

KIT 4CN.0VM.0027.00 (INOX)

A pagamento - Extra -
En supplément - De pago:

— N°3 Fischer FUR 8x80T INOX

Cartongesso e legno stratificato - Plasterboard, Wooden plate - Placoplâtre - Panneau de bois lamellé - Panel de cartón yeso y madera laminada

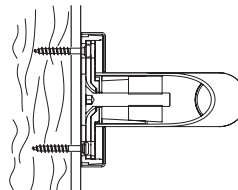

KIT 4CN.0VM.0010.00
A pagamento - Extra -
En supplément - De pago:

— N°3 6x80

Calcestruzzo e Pietra naturale - Concrete, Natural stone - Béton et Pierre naturelle - Hormigón y piedra natural

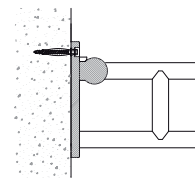

KIT 4CN.0VM.0014.00
In dotazione - Included
- Inclus - Includido:

— N°3 Fischer FU 10x60
— N°3 6,3x80
⊙ N°3 bussole guida
guide bushes
douilles de guidage
führungsbuchse
geleidmof

Mattone pieno e Mattone calcareo - Solid brick, Sand-lime brick - Brique pleine et brique calcaire - Ladrillo macizo y sílico calcáreo

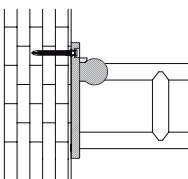

KIT 4CN.0VM.0015.00
A pagamento - Extra - En
supplément - De pago:

— N°3 Fischer FUR 10x80SS
— N°3 7x85

KIT 4CN.0VM.0029.00 (INOX)

A pagamento - Extra - En
supplément - Gegen Bezahlung:

— N°3 Fischer FUR 10x80SS INOX
— N°3 7x85

Mattone forato - Hollow brick masonry - Brique creuse - Ladrillo hueco

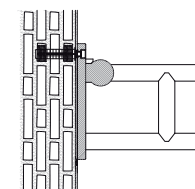

KIT 4CN.0VM.0016.00
A pagamento - Extra - En
supplément - De pago:

— N°3 Fischer FIS H 20X85 K
— N°3 M10X30 INOX
— N°3 FIS E 15X85 M10

Cartongesso e legno stratificato - Plasterboard, Wooden plate - Placoplâtre - Panneau de bois lamellé - Panel de cartón yeso y madera laminada

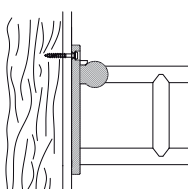

KIT 4CN.0VM.0017.00
A pagamento - Extra - En
supplément - De pago:

— N°3 8x90
⊙ N°3 bussole guida
guide bushes
douilles de guidage
casquillo guía

| 80 |



Art. 4CN.445.0CPM.00

NOTA: PER FISSAGGI SU ALTRI MATERIALI E PER LO SPESSORE MINIMO DEL LEGNO DA UTILIZZARE COME RINFORZO DEL CARTONGESSO, RIVOLGERSI ALL'UFFICIO TECNICO pba.

NOTE: FOR FIXING ON OTHER MATERIALS AND FOR THE MINIMUM THICKNESS OF THE WOOD REINFORCEMENT FOR PLASTERBOARD, PLEASE CONTACT pba TECHNICAL DEPT.

REMARQUE: POUR FIXATION SUR D'AUTRES MATÉRIAUX ET POUR L'ÉPAISSEUR MINIMUM DU BOIS À UTILISER COMME RENFORCEMENT DANS LE PLACOPLÂTRE, CONTACTEZ LE SERVICE TECHNIQUE pba.

NOTA: PARA FIJAR EN OTROS MATERIALES Y PARA EL ESPESOR MÍNIMO DE LA MADERA QUE HAY QUE UTILIZAR COMO REFUERZO DEL PANEL DE CARTÓN YESO, CONTACTEN EL DEPARTAMENTO TÉCNICO pba.

Per le etichette energetiche degli apparecchi di illuminazione: www.pba.it

For the Energy Labels of the illumination instruments see our website: www.pba.it

Pour l'étiquette-énergie des nos appareils d'éclairage voir le site: www.pba.it

Para las etiquetas energéticas de los dispositivos de iluminación: www.pba.it

ANTISUICIDE

CARICHI REGOLABILI (Art. 4CS.436.XXXX .xx)

La resistenza al carico dei singoli agganci del reggiteda è regolabile da pba S.p.A. secondo le specifiche d'ordine. La resistenza al carico nel punto centrale, tra due punti di fissaggio (F), equivale alla somma delle resistenze dei singoli punti di fissaggio.
 $5 \text{ kg} \leq F \leq 30 \text{ kg}$

ADJUSTABLE LOAD RESISTANCE (Art. 4CS.436.XXXX .xx)

The load resistance of each ceiling support is adjustable by pba S.p.A. according to customer specifications. The load resistance at midpoint between two ceiling supports (F) is equal to the sum of the load resistance of each ceiling support.
 $5 \text{ kg} \leq F \leq 30 \text{ kg}$

CHARGES RÉGLABLES (Art. 4CS.436.XXXX .xx)

La résistance de charge de chaque support plafond est réglable par pba S.p.A selon les spécifications du client. La résistance de charge au milieu, entre deux supports plafond (F) est égal à la somme de la résistance de chaque support plafond.
 $5 \text{ kg} \leq F \leq 30 \text{ kg}$

CARGAS AJUSTABLES (Art. 4CS.436.XXXX .xx)

La resistencia a la carga de cada soporte de techo de las barras de cortina es ajustable por pba S.p.A. de acuerdo con las especificaciones del cliente. La resistencia a la carga en el punto central, entre dos puntos de fijación (F), es igual a la suma de las resistencias de cada punto de fijación. $5 \text{ kg} \leq F \leq 30 \text{ kg}$

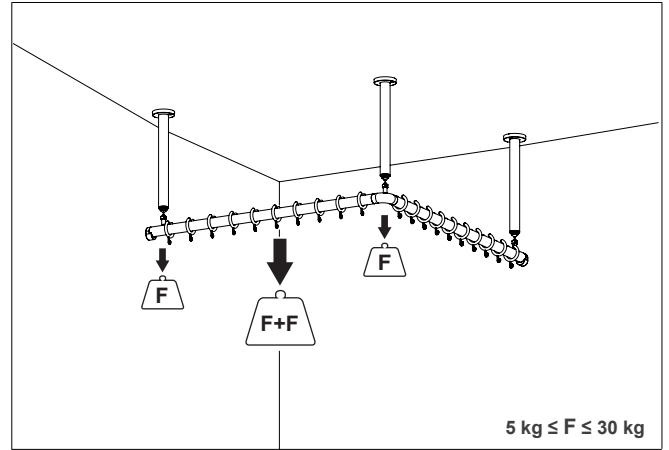

ARTICOLI RIAGGANCIABILI

I reggiteda e i ganci appendiabiti dopo lo sgancio sono facilmente riagganciabili



ARTICLES RACCROCHABLES

Les barres de rideau et les patères se raccrochent facilement en cas de déclenchement.



REATTACHABLE ITEMS

The shower curtain rails and the cloth hooks are easy to be refastened in case of release.



ARTÍCULOS REENGANCHABLES

Las barras de cortina y las perchas se pueden fácilmente reenganchar después del desenganche



ANCORAGGIO ANTICADUTA (Art. 4CS.436.XXXX .xx)

I reggiteda 4CS.436.XXXX.xx sono stati progettati per evitare la caduta a terra della barra dopo lo sgancio.

FIXATION POUR PRÉVENTION DES CHUTES (Art. 4CS.436.XXXX .xx)

Les barres de rideau 4CS.436.XXXX.xx ont été conçues pour empêcher la chute de la barre au sol après le déclenchement.

SECURITY FALL PREVENTION FIXING (Art. 4CS.436.XXXX .xx)

The curtain rails 4CS.436.XXXX.xx have been designed to avoid the rail to falling on the floor in case of release.

FIJACIÓN PARA PREVENCIÓN DE CAÍDAS (Art. 4CS.436.XXXX .xx)

Las barras de cortina 4CS.436.XXXX.xx se han proyectado para evitar la caída al suelo de la barra después del desenganche.

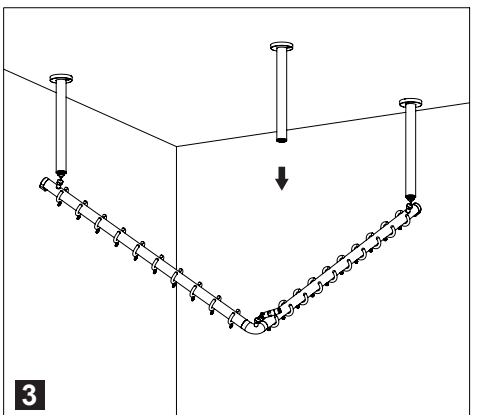
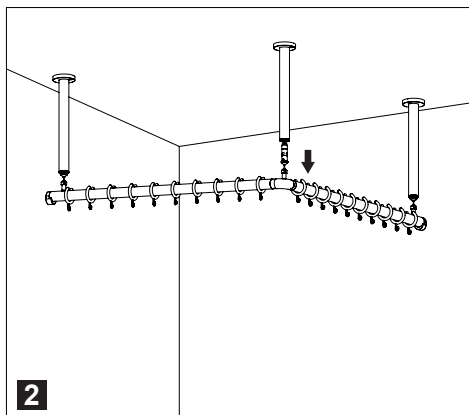
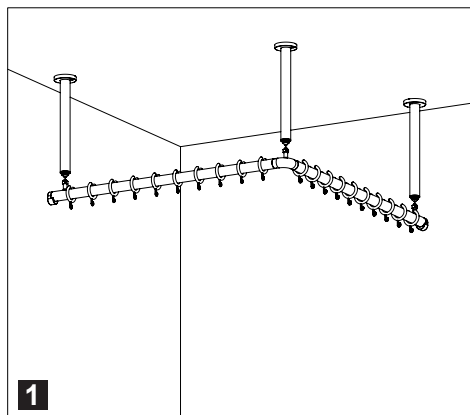

HAND SANITIZER COVER - TECHNICAL INFORMATION AND MAINTENANCE
NOTA PER L'INSTALLAZIONE

Gli Hand-Sanitizer Cover di pba sono compatibili con tutti gli hand sanitizer dispenser automatici che rispettano queste dimensioni massime: 298,5 mm (11.75") h x 163,9 mm (6.45") b x 104,2 mm (4.1") .

INSTALLATION NOTE

pba Hand Sanitizer Covers are compatible with all motion-activated hand sanitizer dispensers with these maximum dimensions: 298,5 mm (11.75") h x 163,9 mm (6.45") b x 104,2 mm (4.1") .

NOTE D'INSTALLATION

Les produits "Hand-Sanitizer Cover" de pba sont compatibles avec tous les distributeurs automatiques de désinfectant pour les mains avec ces dimensions maximales: 298,5 mm (11.75") h x 163,9 mm (6.45") b x 104,2 mm (4.1") .

NOTA DE INSTALACION

Los productos "Hand-Sanitizer Cover" de pba son compatibles con todos los dispensadores automáticos de desinfectante de manos con estas dimensiones máximas: 298,5 mm (11.75") h x 163,9 mm (6.45") b x 104,2 mm (4.1") .

COMPATIBILE CON I SEGUENTI DISTRIBUTORI DI IGIENIZZANTE PER LE MANI:

PURELL CS6 / PURELL CS8
 PURELL TFX
 PURELL LTX-7 / PURELL LTX-12
 ENMOTION GEN2

I distributori di igienizzante per le mani sono compatibili anche in base alle loro dimensioni.

COMPATIBLE WITH THE FOLLOWING HAND SANITIZER DISPENSERS:

PURELL CS6 / PURELL CS8
 PURELL TFX
 PURELL LTX-7 / PURELL LTX-12
 ENMOTION GEN2

The hand sanitizer dispensers are also compatible based on their dimensions.

COMPATIBLE AVEC LES SUIVANTS DISTRIBUTEURS DE DÉSINFECTANT POUR LES MAINS:

PURELL CS6 / PURELL CS8
 PURELL TFX
 PURELL LTX-7 / PURELL LTX-12
 ENMOTION GEN2

Les distributeurs de désinfectant pour les mains sont également compatibles en fonction de leurs dimensions.

COMPATIBLE CON LOS SIGUIENTES DISPENSADORES DE DESINFECTANTE DE MANOS:

PURELL CS6 / PURELL CS8
 PURELL TFX
 PURELL LTX-7 / PURELL LTX-12
 ENMOTION GEN2

Los dispensadores de desinfectante de manos son compatibles también en función de sus dimensiones.

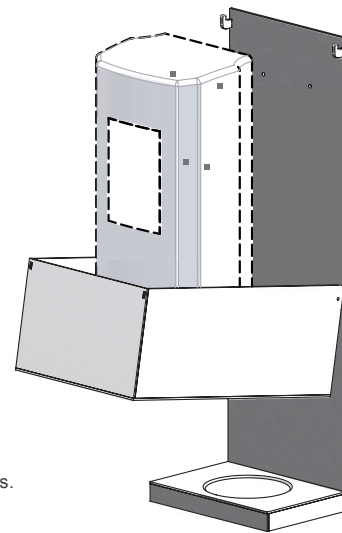
PIATTINO SALVAGOCCIA RIMOVIBILE

Disponibile su richiesta. Da specificare in fase di ordine.

ART. GBA.001.0RDT.xx

REMOVABLE DEEP DRIP TRAY

Available on request to specify during order phase

ART. GBA.001.0RDT.xx

BAC RÉCEPTEUR AMOVIBLE

Disponibile sur demande. À spécifier lors du passage de la commande.

ART. GBA.001.0RDT.xx

BANDEJA DE GOTEO EXTRAÍBLE

Disponibile bajo pedido. A pedir al pasar el pedido.

ART. GBA.001.0RDT.xx

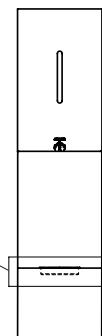
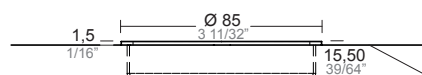

**TEST CITOTOSSICITÀ - CITOTOXICITY TEST
TEST DE CYTOTOXICITÉ
PRUEBA DE CITOTOXICIDAD**

**PROVE DI RESISTENZA AL FUOCO - FIRE-RESISTANCE
PERFORMANCE - ESSAI DE RÉSISTANCE AU FEU -
ENSAYO DE RESISTENCIA AL FUEGO**

Cytotoxicity test to DIN EN ISO 10993-5



MATERIALI - MATERIALS - MATÉRIAUX - MATERIALES: NYLON - ALUMINUM

NYLON

- Resina termoplastica (Poliamide 6).
- Alta resistenza meccanica.
- Tenacità agli urti.
- Resistenza ad usura e abrasione.
- Comportamento antistatico, buon potere di isolamento elettrico e buona resistenza alle correnti striscianti.
- Buona stabilità ad agenti chimici quali idrocarburi, oli, grassi e buona resistenza agli agenti chimici come per esempio solventi, detersivi e disinfettanti.
- Scarsa conducibilità termica.
- Classificata come autoestinguente di categoria UL 94V-2 e non emana gas tossici.
- È fisiologicamente innocuo.
- Soddisfa i requisiti della direttiva 2011/65/EU e non contiene Piombo (Pb), Mercurio (Hg), Cromo Esavalente Cr+6, Bifenili polibromurati (PBB), Etere di difenile polibromurato (PBDE), Cadmio (Cd).

ALLUMINIO

- Robustezza meccanica.
- Ridotto peso specifico.
- Ottima resistenza alla corrosione.

NYLON

- Thermoplastic resin (Polyamide 6).
- High mechanical resistance.
- Tenacity.
- Resistance to wear and abrasion.
- Antistatic, with good insulating power and good resistance to creeping currents.
- Good stability to chemical agents such as hydrocarbons, oils and fats; good resistance to numerous chemical agents such as solvents, detergents and disinfectants.
- Poor thermal conduction.
- Classified as self-extinguishable into category UL 94V-2. It does not generate toxic gases.
- Physiologically innocuous.
- Compliance with the requirements of Directive 2011/65/EU. It is also free of Lead (Pb), Mercury (Hg), Hexavalent Chromium (Cr+6), Polybrominated Biphenyls (PBB), Polybrominated Diphenyl Ethers (PBDE) and Cadmium (Cd).

ALUMINUM

- Mechanical strength.
- Reduced specific weight.
- Excellent resistance to corrosion.

NYLON

- Résine thermoplastique (Polyamide 6).
- Résistance mécanique élevée.
- Grande résistance aux chocs.
- Résistance à l'usure et à l'abrasion.
- Comportement antistatique, bon pouvoir d'isolation électrique et bonne résistance aux courants rampants.
- Bonne stabilité aux agents chimiques, tels que les hydrocarbures, les huiles et les graisses et bonne résistance aux nombreux agents chimiques tels que les solvants, es détergifs et les désinfectants.
- Faible conductivité thermique.
- Classé comme auto-extinguible de catégorie UL 94V-2, il ne libère pas de gaz toxiques.
- Physiologiquement inoffensif.
- Conforme aux directives 2011/65/EU et il ne contient ni de plomb (Pb), ni de mercure (Hg), ni de chrome hexavalent (Cr+6), ni de polybromodiphényles (PBB), ni de polybromodiphényléthers (PBDE) (PBDE), ni de cadmium (Cd).

ALUMINIUM

- Robustesse mécanique.
- Poids spécifique réduit.
- Très bonne résistance à la corrosion.

NYLON

- Resina de termoplástica (Poliamida 6).
- Alta resistencia mecánica.
- Resistencia contra impactos.
- Resistencia a desgaste y abrasión.
- Comportamiento antiestático, buen poder de aislamiento eléctrico y buena resistencia a corrientes de arrastre.
- Buena estabilidad a agentes químicos como hidrocarburos, aceites, grasas y buena resistencia a numerosísimos agentes químicos, como, por ejemplo, disolventes, detergentes y desinfectantes.
- Escasa conductibilidad térmica.
- Clasificada como auto-extinguible de clase UL 94V-2 y no emana gases tóxicos.
- Es fisiológicamente inocuo.
- Conforme a los requisitos de las directivas 2011/65/EU, no contiene plomo (Pb), mercurio (Hg), cromo hexavalente (Cr+6y), polibromobifenilos (PBB), polibromodifenil éteres (PBDE), y cadmio (Cd).

ALUMINIO

- Robustez mecánica.
- Extraordinaria ligereza.
- Buena resistencia a corrosión.

PULIZIA - MAINTENANCE - NETTOYAGE - LIMPIEZA

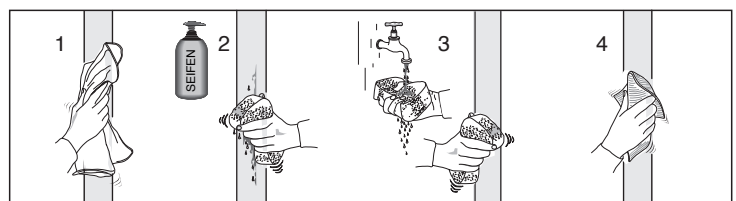
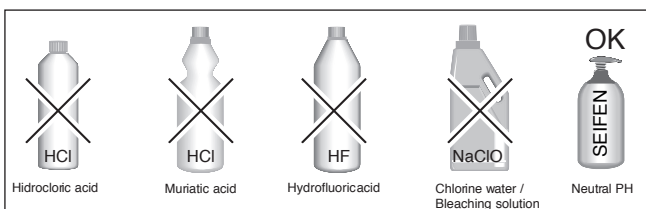

MATERIALI - MATERIALS - MATÉRIAUX - MATERIALES: STAINLESS STEEL AISI 316L
Chemical compositions of AISI stainless steel grades

Material - Stainless	C%	Cr%	Ni%	Mo%
AISI 430 (1.4016)	0,12 max	14.0-18.0	/	/
AISI 304 (1.4301)	0,08 max	18.0-20.0	8.0-10.5	/
AISI 316 (1.4401)	0,08 max	16.0-18.0	10.0-14.0	2.00-3.00
pba AIS 316L (1.4404)*	0,03 max	16.0-18.0	10.0-14.0	2.00-3.00

*Standard pba

Estimated pit corrosion penetration time - time to penetrate 1 mm (years) by steel type

Material - Stainless	Marine	Semi_industrial	Rural
AISI 430 (1.4016)	N/A	85	250
AISI 304 (1.4301)	145	135	770
AISI 316 (1.4401)	260	525	1200

Source: The British Stainless Steel Association (BSSA)

CERTIFICAZIONE MATERIALE - MATERIAL CERTIFICATION - CERTIFICATION DU MATÉRIEL - CERTIFICACIÓN DEL MATERIAL: STAINLESS STEEL AISI 316L

L'acciaio usato da pba, acciaio inox AISI 316L (1), garantisce il massimo grado di resistenza alla corrosione: normativa di riferimento UNI EN 1670; certificazione ottenuta dopo test di corrosione in nebbia salina secondo UNI ISO 9227.

(1) X2CrNiMo 17-12-2 secondo designazione EN 10088-3

The AISI 316L stainless steel (1) steel used by pba, meets the requirements of UNI EN 1670, the ultimate quality standard for ensuring resistance to corrosion. Pba has been awarded a certificate for successfully salt spray testing the stainless steel in accordance with UNI ISO 9227.

(1) X2CrNiMo 17-12-2 as per EN 10088-3

L'acier utilisé par pba, acier inoxydable AISI 316L (1), garantit le degré maximum de résistance à la corrosion : norme de référence UNI EN 1670; certification obtenue après un essai de corrosion par exposition à un brouillard salin conformément à UNI ISO 9227.

(1) X2CrNiMo 17-12-2 conforme à la désignation EN 10088-3

El acero utilizado por pba, acero inoxidable AISI 316L (1), garantiza el grado máximo de resistencia a la corrosión: norma UNI EN 1670; certificación obtenida después de un ensayo de resistencia contra la corrosión en niebla salina según los estándares UNI ISO 9227.

(1) X2CrNiMo 17-12-2 según EN 10088-3

MATERIALI - MATERIALS - MATÉRIAUX - MATERIALES: WOOD
LEGNO

- Essenza Faggio massello.
- Verniciatura trasparente e atossica.
- Scarsa conducibilità termica.
- Assenza di corrosione.
- Buona resistenza meccanica

WOOD

- Solid beech.
- Non toxic transparent paint.
- Poor thermal conduction.
- Absence of corrosion.
- High mechanical resistance

BOIS

- Hêtre massif.
- Peinture transparente et non toxique.
- Faible conductivité thermique.
- Absence de corrosion.
- Résistance mécanique élevée.

MADERA

- Haya maciza.
- Acabado transparente y no tóxico.
- Escasa conductividad térmica.
- Ausencia de corrosión.
- Buena resistencia mecánica

ISTRUZIONE RILIEVO MISURE SCALE - STAIR DIMENSION SURVEY INSTRUCTIONS - INSTRUCTION POUR LE RELEVÉ DES MESURES DES ESCALIERS - INSTRUCCIONES PARA LA DE MEDICIÓN DE ESCALERAS

Rappresentare la vista frontale e dall'alto della scala. Indicare il senso di salita, il numero di gradini, la misura inclinata da spigolo a spigolo (A), la misura del pianerottolo (B), l'alzata (D) e la pedata (E) del gradino.



Draw a front view and a view from the top of the stairs. Indicate the direction of the stairs, the inclined measurement from corner to corner (A), the measurements of the landing (B), and step height (D) and step depth (E).

Représenter une vue de face et une vue de dessus des escaliers. Indiquer le sens de la montée, le nombre de marches, la dimension de la pente d'une arête à l'autre (A), la dimension du palier (B), la hauteur(D) et le giron

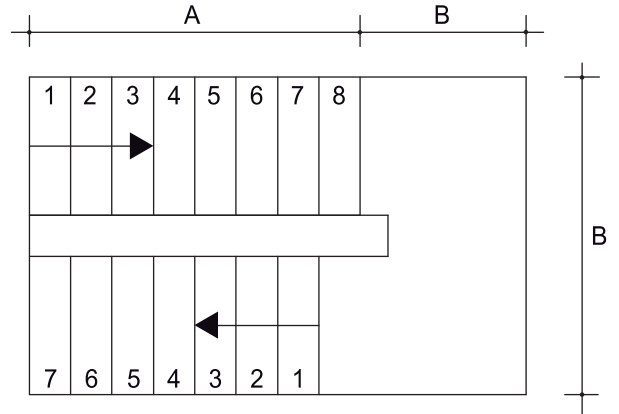
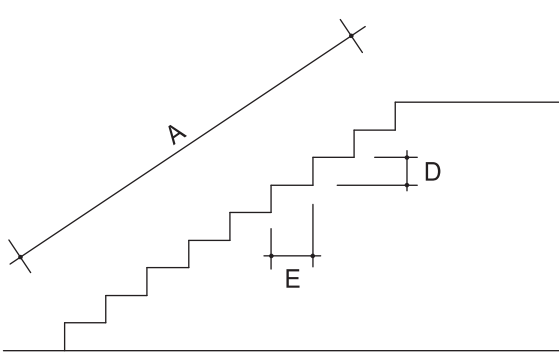
Representar la vista frontal y la superior de la escalera. Indicar la dirección de subida, el número de escalones, la medida inclinada de arista a arista (A), la medida del descansillo (B), la contrahuella (D) y la huella (E).

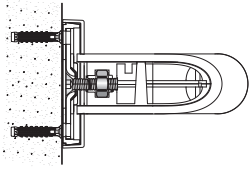
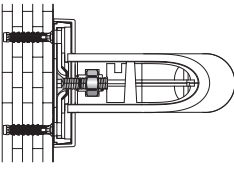
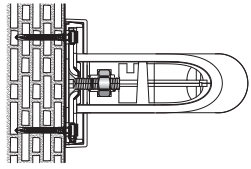
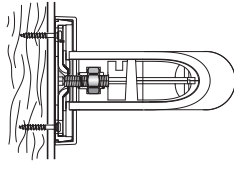

SISTEMI DI FISSAGGIO - FIXING MATERIAL - SISTÈMES DE FIXATION - SISTEMAS DE FIJACIÓN

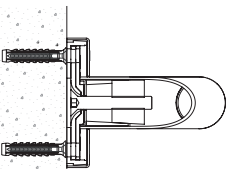
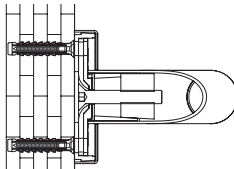
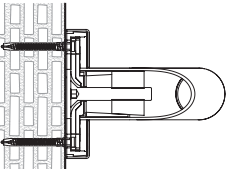
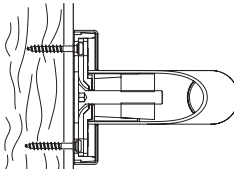
 <p>80 50</p> <p>NYLON</p>	<p>Calcestruzzo e Pietra naturale - Concrete, Natural stone - Béton et Pierre naturelle - Hormigón y piedra natural</p>  <p>KIT 4CN.OVM.0004.00 In dotazione - Included - Inclus - Includido:</p> <ul style="list-style-type: none"> N°3 Fischer SX8 N°3 5x60 	<p>Mattone pieno e Mattone calcareo - Solid brick, Sand-lime brick - Brique pleine et brique calcaire - Ladrillo macizo y sílico calcáreo</p>  <p>KIT 4CN.OVM.0004.00 In dotazione - Included - Inclus - Includido:</p> <ul style="list-style-type: none"> N°3 Fischer SX8 N°3 5x60
<p>NYLON</p>	<p>Mattone forato - Hollow brick masonry - Brique creuse - Ladrillo hueco</p>  <p>KIT 4CN.OVM.0005.00 A pagamento - Extra - En supplément - De pago:</p> <ul style="list-style-type: none"> N°3 Fischer FUR 8x80T <p>KIT 4CN.OVM.0027.00 (INOX) A pagamento - Extra - En supplément - De pago:</p> <ul style="list-style-type: none"> N°3 Fischer FUR 8x80T INOX 	<p>Cartongesso e legno stratificato - Plasterboard, Wooden plate - Placoplâtre - Panneau de bois lamellé - Panel de cartón yeso y madera laminada</p>  <p>KIT 4CN.OVM.0010.00 A pagamento - Extra - En supplément - De pago:</p> <ul style="list-style-type: none"> N°3 7,5x72
 <p>80 50</p> <p>AISI 316L</p>	<p>Calcestruzzo e Pietra naturale - Concrete, Natural stone - Béton et Pierre naturelle - Hormigón y piedra natural</p>  <p>KIT 4CN.OVM.0004.00 In dotazione - Included - Inclus - Includido:</p> <ul style="list-style-type: none"> N°3 Fischer SX8 N°3 5x60 	<p>Mattone pieno e Mattone calcareo - Solid brick, Sand-lime brick - Brique pleine et brique calcaire - Ladrillo macizo y sílico calcáreo</p>  <p>KIT 4CN.OVM.0004.00 In dotazione - Included - Inclus - Includido:</p> <ul style="list-style-type: none"> N°3 Fischer SX8 N°3 5x60
<p>AISI 316L</p>	<p>Mattone forato - Hollow brick masonry - Brique creuse - Ladrillo hueco</p>  <p>KIT 4CN.OVM.0005.00 A pagamento - Extra - En supplément - De pago:</p> <ul style="list-style-type: none"> N°3 Fischer FUR 8x80T <p>KIT 4CN.OVM.0027.00 (INOX) A pagamento - Extra - En supplément - De pago:</p> <ul style="list-style-type: none"> N°3 Fischer FUR 8x80T INOX 	<p>Cartongesso e legno stratificato - Plasterboard, Wooden plate - Placoplâtre - Panneau de bois lamellé - Panel de cartón yeso y madera laminada</p>  <p>KIT 4CN.OVM.0010.00 A pagamento - Extra - En supplément - De pago:</p> <ul style="list-style-type: none"> N°3 7,5x72

NOTA: PER FISSAGGI SU ALTRI MATERIALI E PER LO SPESSORE MINIMO DEL LEGNO DA UTILIZZARE COME RINFORZO DEL CARTONGESSO, RIVOLGERSI ALL'UFFICIO TECNICO pba.
NOTE: FOR FIXING ON OTHER MATERIALS AND FOR THE MINIMUM THICKNESS OF THE WOOD REINFORCEMENT FOR PLASTERBOARD, PLEASE CONTACT pba TECHNICAL DEPT.
REMARQUE: POUR FIXATION SUR D'AUTRES MATÉRIAUX ET POUR L'ÉPAISSEUR MINIMUM DU BOIS À UTILISER COMME RENFORCEMENT DANS LE PLACOPLÂTRE, CONTACTEZ LE SERVICE TECHNIQUE pba.
NOTA: PARA FIJAR EN OTROS MATERIALES Y PARA EL ESPESOR MÍNIMO DE LA MADERA QUE HAY QUE UTILIZAR COMO REFUERZO DEL PANEL DE CARTÓN YESO, CONTACTEN EL DEPARTAMENTO TÉCNICO pba.

CHART OF PBA PRODUCTS CONTRIBUTION TO LEED V4

INTEGRATIVE PROCESS

IP PREREQUISITE INTEGRATIVE PROCESS PLANNING AND DESIGN

MATERIALS AND RESOURCES

MR PREREQUISITE CONSTRUCTION AND DEMOLITION WASTE MANAGEMENT PLANNING

MR CREDIT CONSTRUCTION AND DEMOLITION WASTE MANAGEMENT

MR CREDIT BUILDING PRODUCT DISCLOSURE AND OPTIMIZATION - SOURCING OF RAW MATERIALS

➔ OPTION 2 LEADERSHIP EXTRACTION PRACTICES

MR CREDIT BUILDING PRODUCT DISCLOSURE AND OPTIMIZATION - MATERIAL INGREDIENTS

➔ OPTION 2 MATERIAL INGREDIENT OPTIMIZATION

INDOOR ENVIRONMENTAL QUALITY

EQ CREDIT LOW EMITTING MATERIALS

EQ CREDIT CONSTRUCTION AIR QUALITY MANAGEMENT PLAN

INNOVATION

IN PILOT CREDIT

➤ DESIGN FOR FLEXIBILITY

IN PILOT CREDIT

➤ SOCIAL EQUITY

IN PILOT CREDIT

➤ INCLUSIVE DESIGN

IN CREDIT

➤ DESIGN FOR DECONSTRUCTION



MAPPED PBA PRODUCTS

ARCHITECTURAL HARDWARE

Accessories for doors and windows
Locksets
Accessories for toilet cubicles



DESIGN FOR ALL

Barrier free
Bathroom accessories
Handrail



pba S.p.A.
Tezze sul Brenta (VI)
Italy
info@pba.it

pba USA Inc.
New York
United States
office@pba-usa.us

pba Deutschland GmbH
Tönisvorst
Deutschland
info@de.pba.it



Declare.

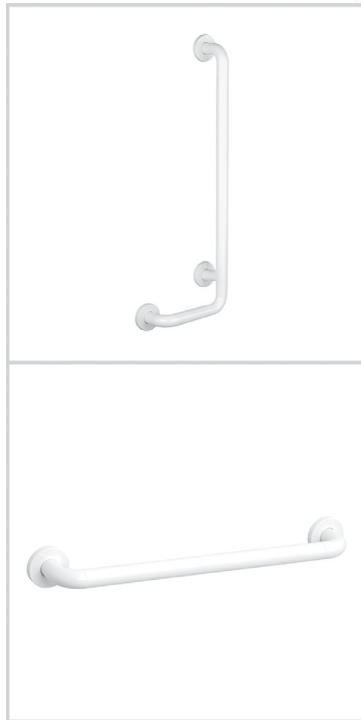

Declare.

POLYAMIDE-6 BATHROOM ACCESSORIES pba

Final Assembly: Tezze sul Brenta, Vicenza, Italy
Life Expectancy: 20 Year(s)
End of Life Options: Recyclable (100%)

Ingredients:

Polyamide 6; Nylon 6; Aluminium 46100; Aluminum; Alluminio LEGA EN AW-6060; Aluminum; Stainless Steel AISI 316L; Stainless Steel AISI 316; Stainless Steel AISI 304; Stainless Steel AISI 316; Brass; Zinc Casting Alloys: Zinc; Aluminum; Copper; Brass; Brass

Living Building Challenge Criteria: Compliant

I-13 Red List:
 LBC Red List Free % Disclosed: 100% at 100ppm
 LBC Red List Approved VOC Content: Not Applicable
 Declared

I-10 Interior Performance: AgBB Scheme French A+ 2011
I-14 Responsible Sourcing: Not Applicable

PBA-0006

Original Issue Date: 2021

MANUFACTURED BY: PBA
INTERNATIONAL LIVING FUTURE INSTITUTE™ living-future.org/declare



Declare.

STAINLESS STEEL BATHROOM ACCESSORIES AND GRAB BARS pba

Final Assembly: Tezze sul Brenta, Vicenza, Italy
Life Expectancy: 20 Year(s)
End of Life Options: Recyclable (100%)

Ingredients:

Stainless Steel AISI 316L; Stainless Steel AISI 316; Aluminium 47100; Aluminum; Stainless Steel AISI 304; Stainless Steel AISI 316; Polyamide 6; Nylon 6; Stainless Steel AISI 303; Stainless Steel AISI 316; Brass; Brass; Powder coat: Fatty acids, castor-oil, caustic-oxidized, distn, residues, esters with 1,3-butenediol; Barium sulfate; Titanium dioxide; N,N,N',N'-Tetrakis(2-hydroxyethyl)hexane diamide

Living Building Challenge Criteria: Compliant

I-13 Red List:
 LBC Red List Free % Disclosed: 100% at 100ppm
 LBC Red List Approved VOC Content: Not Applicable
 Declared

I-10 Interior Performance: Not Applicable
I-14 Responsible Sourcing: Not Applicable

PBA-0005

Original Issue Date: 2021

MANUFACTURED BY: PBA
INTERNATIONAL LIVING FUTURE INSTITUTE™ living-future.org/declare

Declare.

2CC, 2CE, 2CO, 2CP, 2MH, 01T - Pulls, levers, knobs and accessories pba

Final Assembly: Tezze sul Brenta, Vicenza, Italy
Life Expectancy: 20 Year(s)
End of Life Options: Recyclable (100%)

Ingredients:
 Stainless Steel AISI 316L; Stainless Steel AISI 316; Aluminium 47100; Aluminum; Stainless Steel AISI 304; Stainless Steel AISI 316; Polyamide 6; Nylon 6; Stainless Steel AISI 303; Stainless Steel AISI 316; Brass; Brass; Powder coat: Fatty acids, castor-oil, caustic-oxidized, distn, residues, esters with 1,3-butenediol; Barium sulfate; Titanium dioxide

Living Building Challenge Criteria: Compliant

I-13 Red List:
 LBC Red List Free % Disclosed: 100% at 100ppm
 LBC Red List Approved VOC Content: Not Applicable
 Declared

I-10 Interior Performance: Not Applicable
I-14 Responsible Sourcing: Not Applicable

PBA-0004
Original Issue Date: 2021

MANUFACTURED BY: PBA
INTERNATIONAL LIVING FUTURE INSTITUTE™ living-future.org/declare

Declare.

2CC, 2CE, 2CO, 2CP, 2MH, 01T - Pulls, levers, knobs and accessories pba

Final Assembly: Tezze sul Brenta, Vicenza, Italy
Life Expectancy: 20 Year(s)
End of Life Options: Recyclable (100%)

Ingredients:
 Stainless Steel AISI 316L; Stainless Steel AISI 316; Aluminium 47100; Aluminum; Stainless Steel AISI 304; Stainless Steel AISI 316; Polyamide 6; Nylon 6; Stainless Steel AISI 303; Stainless Steel AISI 316; Brass; Brass; Powder coat: Fatty acids, castor-oil, caustic-oxidized, distn, residues, esters with 1,3-butenediol; Barium sulfate; Titanium dioxide

Living Building Challenge Criteria: Compliant

I-13 Red List:
 LBC Red List Free % Disclosed: 100% at 100ppm
 LBC Red List Approved VOC Content: Not Applicable
 Declared

I-10 Interior Performance: Not Applicable
I-14 Responsible Sourcing: Not Applicable

PBA-0004
Original Issue Date: 2021

MANUFACTURED BY: PBA
INTERNATIONAL LIVING FUTURE INSTITUTE™ living-future.org/declare

Declare.

2CC, 2CE, 2CO, 2CP, 2MH, 01T - Pulls, levers, knobs and accessories pba

Final Assembly: Tezze sul Brenta, Vicenza, Italy
Life Expectancy: 20 Year(s)
End of Life Options: Recyclable (100%)

Ingredients:
 Stainless Steel AISI 316L; Stainless Steel AISI 316; Aluminium 47100; Aluminum; Stainless Steel AISI 304; Stainless Steel AISI 316; Polyamide 6; Nylon 6; Stainless Steel AISI 303; Stainless Steel AISI 316; Brass; Brass; Powder coat: Fatty acids, castor-oil, caustic-oxidized, distn, residues, esters with 1,3-butenediol; Barium sulfate; Titanium dioxide

Living Building Challenge Criteria: Compliant

I-13 Red List:
 LBC Red List Free % Disclosed: 100% at 100ppm
 LBC Red List Approved VOC Content: Not Applicable
 Declared

I-10 Interior Performance: Not Applicable
I-14 Responsible Sourcing: Not Applicable

PBA-0004
Original Issue Date: 2021

MANUFACTURED BY: PBA
INTERNATIONAL LIVING FUTURE INSTITUTE™ living-future.org/declare

Declare.

KLO - Locking and non-locking ladder pulls pba

Final Assembly: Tezze sul Brenta, Vicenza, Italy
Life Expectancy: 20 Year(s)
End of Life Options: Recyclable (100%)

Ingredients:
 Stainless Steel AISI 316L; Stainless Steel AISI 316; Aluminium 47100; Aluminum; Stainless Steel AISI 304; Stainless Steel AISI 316; Polyamide 6; Nylon 6; Stainless Steel AISI 303; Stainless Steel AISI 316; Brass; Brass; Powder coat: Fatty acids, castor-oil, caustic-oxidized, distn, residues, esters with 1,3-butenediol; Barium sulfate; Titanium dioxide

Living Building Challenge Criteria: Compliant

I-13 Red List:
 LBC Red List Free % Disclosed: 100% at 100ppm
 LBC Red List Approved VOC Content: Not Applicable
 Declared

I-10 Interior Performance: Not Applicable
I-14 Responsible Sourcing: Not Applicable

PBA-0003
Original Issue Date: 2021

MANUFACTURED BY: PBA
INTERNATIONAL LIVING FUTURE INSTITUTE™ living-future.org/declare

Declare.

KL A, 2AT, 2AH - Locking and non-locking ladder pulls, levers and levers pba

Final Assembly: Tezze sul Brenta, Vicenza, Italy
Life Expectancy: 20 Year(s)
End of Life Options: Recyclable (100%)

Ingredients:
 Stainless Steel AISI 316L; Stainless Steel AISI 316; Aluminium 47100; Aluminum; Stainless Steel AISI 304; Stainless Steel AISI 316; Polyamide 6; Nylon 6; Stainless Steel AISI 303; Stainless Steel AISI 316; Brass; Brass; Powder coat: Fatty acids, castor-oil, caustic-oxidized, distn, residues, esters with 1,3-butenediol; Barium sulfate; Titanium dioxide

Living Building Challenge Criteria: Compliant

I-13 Red List:
 LBC Red List Free % Disclosed: 100% at 100ppm
 LBC Red List Approved VOC Content: Not Applicable
 Declared

I-10 Interior Performance: Not Applicable
I-14 Responsible Sourcing: Not Applicable

PBA-0002
Original Issue Date: 2021

MANUFACTURED BY: PBA
INTERNATIONAL LIVING FUTURE INSTITUTE™ living-future.org/declare

Declare.

GHP, GHP - Millwork pulls and Hands-Free Pulls pba

Final Assembly: Tezze sul Brenta, Vicenza, Italy
Life Expectancy: 20 Year(s)
End of Life Options: Recyclable (100%)

Ingredients:
 Stainless Steel AISI 316L; Stainless Steel AISI 316; Aluminium 47100; Aluminum; Stainless Steel AISI 304; Stainless Steel AISI 316; Polyamide 6; Nylon 6; Stainless Steel AISI 303; Stainless Steel AISI 316; Brass; Brass; Powder coat: Fatty acids, castor-oil, caustic-oxidized, distn, residues, esters with 1,3-butenediol; Barium sulfate; Titanium dioxide

Living Building Challenge Criteria: Compliant

I-13 Red List:
 LBC Red List Free % Disclosed: 100% at 100ppm
 LBC Red List Approved VOC Content: Not Applicable
 Declared

I-10 Interior Performance: Not Applicable
I-14 Responsible Sourcing: Not Applicable

PBA-0001
Original Issue Date: 2021

MANUFACTURED BY: PBA
INTERNATIONAL LIVING FUTURE INSTITUTE™ living-future.org/declare

Declare.

GHP, GHP - Millwork pulls and Hands-Free Pulls pba

Final Assembly: Tezze sul Brenta, Vicenza, Italy
Life Expectancy: 20 Year(s)
End of Life Options: Recyclable (100%)

Ingredients:
 Stainless Steel AISI 316L; Stainless Steel AISI 316; Aluminium 47100; Aluminum; Stainless Steel AISI 304; Stainless Steel AISI 316; Polyamide 6; Nylon 6; Stainless Steel AISI 303; Stainless Steel AISI 316; Brass; Brass; Powder coat: Fatty acids, castor-oil, caustic-oxidized, distn, residues, esters with 1,3-butenediol; Barium sulfate; Titanium dioxide

Living Building Challenge Criteria: Compliant

I-13 Red List:
 LBC Red List Free % Disclosed: 100% at 100ppm
 LBC Red List Approved VOC Content: Not Applicable
 Declared

I-10 Interior Performance: Not Applicable
I-14 Responsible Sourcing: Not Applicable

PBA-0001
Original Issue Date: 2021

MANUFACTURED BY: PBA
INTERNATIONAL LIVING FUTURE INSTITUTE™ living-future.org/declare

Declare.

KL A, 2AT, 2AH - Locking and non-locking ladder pulls, levers and levers pba

Final Assembly: Tezze sul Brenta, Vicenza, Italy
Life Expectancy: 20 Year(s)
End of Life Options: Recyclable (100%)

Ingredients:
 Stainless Steel AISI 316L; Stainless Steel AISI 316; Aluminium 47100; Aluminum; Stainless Steel AISI 304; Stainless Steel AISI 316; Polyamide 6; Nylon 6; Stainless Steel AISI 303; Stainless Steel AISI 316; Brass; Brass; Powder coat: Fatty acids, castor-oil, caustic-oxidized, distn, residues, esters with 1,3-butenediol; Barium sulfate; Titanium dioxide

Living Building Challenge Criteria: Compliant

I-13 Red List:
 LBC Red List Free % Disclosed: 100% at 100ppm
 LBC Red List Approved VOC Content: Not Applicable
 Declared

I-10 Interior Performance: Not Applicable
I-14 Responsible Sourcing: Not Applicable

PBA-0002
Original Issue Date: 2021

MANUFACTURED BY: PBA
INTERNATIONAL LIVING FUTURE INSTITUTE™ living-future.org/declare

PROGRAMMA WF

SISTEMA CON GUARNIZIONE PER INSTALLAZIONE DI PRODOTTI SECONDO LE PRESCRIZIONI DELLA NORMATIVA DIN18534. ADATTO PER PARETI DOCCIA IN BAGNI PER OSPEDALI, RESIDENZE SANITARIE ASSISTITE, ABITAZIONI PRIVATE. GRADO DI PROTEZIONE MINIMO PER ISOLAMENTO GARANTITO DI GRADO W1-I SECONDO NORMATIVA DIN18534. IL SISTEMA E' COSTITUITO DALLA COMBINAZIONE DI UNA MEMBRANA GOMMOSA, ELASTICA E IMPERMEABILE IN TESSUTO DI FIBRA DI VETRO O SIMILE, SPESSA CIRCA 1 MM, ACCOPIATA CON UNA SECONDA MEMBRANA SPUGNOSA A CELLE CHIUSE O SEMICHIUSE, IMPERMEABILE, COMPRIMIBILE ED ELASTICA DI SPESSORE 5-6 MM.

SYSTEM SOLUTION WITH GASKET FOR INSTALLATION OF PRODUCTS ACCORDING TO THE REQUIREMENTS OF THE DIN18534 STANDARDS. SUITABLE FOR SHOWER WALLS IN HOSPITALS BATHROOMS, RETIREMENT HOMES, PRIVATE HOMES. MINIMUM DEGREE OF PROTECTION FOR GUARANTEED INSULATION W1-I ACCORDING TO DIN18534. THE SYSTEM CONSISTS IN A COMBINATION OF A WATERPROOF ELASTIC RUBBER MEMBRANE MADE OF FIBERGLASS OR SIMILAR OF ABOUT 1 MM THICKNESS COUPLED WITH A SECOND WATERPROOF, COMPRESSIBLE AND ELASTIC SPONGE MEMBRANE OF ABOUT 5-6 MM THICKNESS WITH CLOSED OR SEMI-CLOSED CELL.

SOLUTION DE SYSTÈME AVEC JOINT POUR L'INSTALLATION DE PRODUITS CONFORMÉMENT AUX STANDARDS DE LA NORME DIN18534. APPROPRIÉ POUR MURS DE DOUCHES DANS SALLES DE BAINS DES HÔPITAUX, MAISONS DE RETRAITE, RÉSIDENCES PRIVÉES. CLASSE MINIMALE DE PROTECTION POUR ÉTANCHÉITÉ GARANTIE W1-I SELON NORME DIN18534. LE SYSTÈME SE COMPOSE D'UNE COMBINAISON DE MEMBRANE ÉLASTIQUE CAOUTCHOUTEUSE ÉTANCHÉE FAITE DE TISSU EN FIBRE DE VERRE OU SIMILAIRE D'ENVIRON 1 MM D'ÉPAISSEUR ACCOPLÉE AVEC UNE SECONDE MEMBRANE ÉPONGE À CELLULES FERMÉES OU SEMI-FERMÉES, ÉTANCHE, COMPRIMÉE ÉLASTIQUE D'ÉPAISSEUR 5-6 MM.

SOLUCIÓN DE SISTEMA CON JUNTA DE ESTANQUEIDAD PARA LA INSTALACIÓN DE PRODUCTOS CONFORME A LOS ESTÁNDARES DE LA NORMA DIN 18534. APROPIADO PARA PAREDES DE DUCHAS DE BAÑOS DE HOSPITALES, RESIDENCIAS PARA MAYORES, RESIDENCIAS PRIVADAS. CLASE MÍNIMA DE PROTECCIÓN IMPERMEABLE GARANTIZADA W1-I SEGÚN NORMA DIN18534. EL SISTEMA SE COMPONE DE UNA COMBINACIÓN DE UNA MEMBRANA ELÁSTICA GOMOSA IMPERMEABLE DE TEJIDO DE FIBRA DE VIDRIO O SIMILAR DE GROSOR 1 MM UNIDA A UNA SEGUNDA MEMBRANA ESPONJOSA A CELDAS CERRADAS O SEMICERRADAS, IMPERMEABLE, COMPRIMIBLE ELÁSTICA DE GROSOR 5-6 MM.



PHOTOS:
GABRIELE BASILICO
FABIO ZONTA

PRINTED IN ITALY

pba S.p.A. T +39 0424 5451 info@pba.it www.pba.it

pba USA, Inc. T +1 212 255 4605 salesusa@pba-usa.us www.pba.it

pba S.p.A. Deutschland T +49 2151 820060 info@de.pba.it www.pba.it